

Residential Smart Off-Grid Inverter Solutions

EO 3.5-6.0kW+Lynx Home A

User Manual

Copyright Statement:

Copyright © GoodWe Technologies Co. Ltd. 2024. All rights reserved.

No part of this manual can be reproduced or transmitted to the public platform in any form or by any means without the prior written authorization of GoodWe Technologies Co.,Ltd.

Trademarks

GOODWE and other GOODWE trademarks are trademarks of GoodWe Technologies Co., Ltd. All other trademarks or registered trademarks mentioned in this manual are owned by the company.

NOTICE

The information in this user manual is subject to change due to product updates or other reasons. This manual cannot replace the product safety labels unless otherwise specified. All descriptions in the manual are for guidance only.

1 About This Manual	8
1.1 Overview.....	8
1.2 Applicable Model	8
1.3 Symbol Definition.....	8
2 Safety Precautions	9
2.1 General Safety	9
2.2 Personnel Requirements.....	10
2.3 System Installation.....	10
2.3.1 PV String Safety.....	11
2.3.2 Off-grid Inverter Safety	11
2.3.3 Battery Safety.....	12
2.4 Safety Symbols and Certification Marks	13
2.5 EU Declaration of Conformity.....	15
2.5.1 Equipment with Wireless Communication Modules.....	15
2.5.2 Equipment without Wireless Communication Modules (Except Battery)	
.....	15
2.5.3 Battery	16
3 System Introduction.....	17
3.1 System Overview	17
3.2 Product Overview.....	19
3.2.1 Off-grid Inverter.....	19
3.2.2 Battery	19
3.2.3 Smart Dongle.....	20
3.3 Supported Grid Types.....	21
3.4 System Working Mode.....	21
4 Check and Storage.....	24

4.1 Check before Acceptance.....	24
4.2 Package Content.....	24
4.2.1 Off-grid Inverter Deliverables (EO).....	25
4.2.2 Battery Deliverables (Lynx Home A)	25
4.2.3 Smart Dongle (WiFi/ LAN Kit-20).....	27
4.3 Storage.....	27
5 Installation	28
5.1 System Installation and Commissioning Procedure	28
5.2 Installation Requirements	29
5.2.1 Installation Environment Requirements	29
5.2.2 Installation Space Requirements.....	30
5.2.3 Tool Requirements	31
5.3 Equipment Handling	32
5.4 Installation the Off-grid Inverter.....	32
5.5 Installing the Battery System	33
6 System Wirings	35
6.1 System Wiring Diagram	36
6.2 Detailed System Wiring Diagram	38
6.2.1 Single Inverter System Wiring Diagram	38
6.2.2 Single-phase Parallel System Wiring Diagram.....	38
6.2.3 Three-phase System Wiring Diagram	39
6.3 Preparing Materials	39
6.3.1 Preparing Breakers	40
6.3.2 Preparing Cables	40
6.4 Connecting the PE cable.....	41

6.5 Connecting the PV Cable.....	42
6.6 Connecting the Battery Cable.....	43
6.6.1 Connecting the Power Cable between Inverter and Battery	48
6.6.2 Connect the Communication Cable between Inverter and Battery	51
6.7 Connecting the AC Cable	53
6.8 Connect the Inverter Communication Cable.....	54
6.9 Connect the Smart Dongle.....	56
7 System Commissioning.....	57
7.1 Check before Power ON	57
7.2 Power ON.....	57
7.2.1 Power on a Single Inverter System.....	58
7.2.2 Power on a Multi-inverter System.....	58
7.3 Indicators.....	60
7.3.1 Off-grid Inverter Indicator.....	60
7.3.2 Battery Indicators	60
7.3.4 Smart Dongle Indicator.....	61
8 Quick System Commissioning	63
8.1 Downloading the App	63
8.2 Connect the Inverter through SolarGo.....	64
8.3 Communication Settings	65
8.4 Quick Settings	65
8.5 Creating Power Plants.....	70
9 System Commissioning.....	71
9.1 Set Parameters through LCD Screen	71
9.1.1 Introduction to LCD Screen.....	71

9.1.2 LCD Screen Settings.....	73
9.1 SolarGo Overview.....	78
9.2.1 App Interface Structure	79
9.2.2 Introduction to the SolarGo App Login Interface	80
9.2.3 Introduction to the Main Interface of SolarGo App.....	81
9.3 Connecting the Inverter via SolarGo	82
9.4 Communication Configuration.....	83
9.5 Quick Settings	84
9.6 Basic Settings.....	89
9.6.1 Setting Basic Parameters	89
9.7 Advanced Settings	91
9.7.1 Set AFCI detection.....	91
9.7.2 Set Battery Function.....	91
9.7.3 Setting Safety Parameters	92
9.8 Port Connection.....	99
9.8.1 Setting Generator Control.....	99
9.8.2 Setting Load Control	102
10 Monitoring Power Plant	104
10.1 SEMS Portal Overview.....	104
10.2 Manage the Plant or Devices.....	106
10.2.1 Creating Power Plant	106
10.2.2 Managing the Plant.....	107
10.2.3 Managing the Devices.....	108
10.3 Monitoring Power Plant	109
10.3.1 Viewing Power Plant Information	109

10.3.2 View Alarm Information.....	110
11 Maintenance.....	111
11.1 Power OFF the System	111
11.2 Removing the Equipment	113
11.3 Disposing of the Equipment	114
11.4 Routine Maintenance	114
11.5 Troubleshooting	115
11.5.1 System Troubleshooting	115
11.5.2 Inverter Troubleshooting.....	117
11.5.3 Battery Fault (Lynx home A).....	127
12 Parameters	130
12.1 Inverter Parameters.....	130
12.2 Battery Technical Data.....	136
12.3 Smart Dongle Technical Data	137
13 Appendix	139
13.1 FAQ.....	139
13.1.1 How to upgrade device version.....	139
13.2 Abbreviations	139

1 About This Manual

1.1 Overview

The energy storage system consists of off-grid inverter and battery system. This manual describes the product information, installation, electrical connection, commissioning, troubleshooting and maintenance of the system. Read through this manual before installing and operating the products. This manual is subject to update without notice. For more product details and latest documents, visit <https://en.goodwe.com/>.

1.2 Applicable Model

The energy storage system consists the following products:

Product type	Product information	Description
Off-grid inverter	EO series	Nominal output power: 3.5kW-6.0kW
Battery system	LX A5.0-10	Useable energy of 5.0kWh, supports a maximum of 15 batteries connected in parallel.
Smart dongle	WiFi/LAN Kit-20	System operation information can be uploaded to the monitoring platform via WiFi or LAN signals.

1.3 Symbol Definition



Indicates a high-level hazard that, if not avoided, will result in death or serious injury.



Indicates a medium-level hazard that, if not avoided, could result in death or serious injury.

CAUTION

Indicates a low-level hazard that, if not avoided, could result in minor or moderate injury.

NOTICE

Highlights key information and supplements the texts. Or some skills and methods to solve product-related problems to save time.

2 Safety Precautions

Please strictly follow these safety instructions in the user manual during the operation.

WARNING

The products are designed and tested strictly to comply with related safety rules. Read and follow all the safety instructions and cautions before any operations. Improper operation might cause personal injury or property damage as the products are electrical equipment.

2.1 General Safety

NOTICE

- The information in this user manual is subject to change due to product updates or other reasons. This manual cannot replace the product safety labels unless otherwise specified. All descriptions in the manual are for guidance only.
- Before installations, read through the user manual to learn about the product and the precautions.
- All operations should be performed by trained and knowledgeable technicians who are familiar with local standards and safety regulations.
- Use insulating tools and wear personal protective equipment (PPE) when operating the equipment to ensure personal safety. Wear anti-static gloves, cloths, and wrist strips when touching electronic devices to protect the equipment from damage.
- Unauthorized dismantling or modification may damage the equipment, the damage is not covered under the warranty.
- Strictly follow the installation, operation, and configuration instructions in this manual. The manufacturer shall not be liable for equipment damage or personal injury if you do not follow the instructions. For more warranty details, please visit <https://en.goodwe.com/warranty>.

2.2 Personnel Requirements

NOTICE

- Personnel who install or maintain the equipment must be strictly trained, learn about safety precautions and correct operations.
- Only qualified professionals or trained personnel are allowed to install, operate, maintain, and replace the equipment or parts.

2.3 System Installation

DANGER

- Disconnect the upstream switches to power off the equipment before any electrical connections. Do not work with power on. Otherwise, an electric shock may occur.
- Install a breaker at the voltage input side of the equipment to prevent personal injury or equipment damage caused by energized electrical work.
- All operations such as transportation, storage, installation, use and maintenance shall comply with applicable laws, regulations, standards and specifications.
- Perform electrical connections in compliance with local laws, regulations, standards and specifications. Including operations, cables, and component specifications.
- Connect cables using the connectors included in the package. The manufacturer shall not be liable for equipment damage if other connectors are used.
- Ensure all cables are connected tightly, securely, and correctly. Inappropriate wiring may cause poor contacts and damage the equipment.
- The PE cables must be connected and secured properly.
- To protect the equipment and components from damage during transportation, ensure that the transportation personnel are professionally trained. All operations during the transportation have to be recorded. The equipment shall be kept in balance, thus avoiding falling down.
- The equipment is heavy. Please equip the corresponding personnel according to its weight, so that the equipment does not exceed the weight range of the human body can carry, and cause personnel injury.
- Keep the equipment stable to avoid dumping, which can result in equipment damage and personal injuries.

WARNING

- Do not apply mechanical load to the terminals, otherwise the terminals can be damaged.
- If the cable bears too much tension, the connection may be poor. Reserve a certain length of the cable before connecting it to corresponding ports.
- Tie the cables of the same type together, and place cables of different types at least 30mm apart. Do not place the cables entangled or crossed.
- Place the cables at least 30mm away from the heating components or heat sources, otherwise the insulation layer of the cables may be aging or broken due to high temperature.

2.3.1 PV String Safety



- Ensure the component frames and the bracket system are securely grounded.
- Ensure the DC cables are connected tightly, securely and correctly. Inappropriate wiring may cause poor contacts or high impedances, and damage the inverter.
- Measure the DC cable using the multimeter to avoid reverse polarity connection. Also, the voltage should be under the max DC input voltage. The manufacturer shall not be liable for the damage caused by reverse connection and overvoltage.
- The PV strings cannot be grounded. Ensure the minimum insulation resistance of PV string to the ground meets the minimum insulation resistance requirements before connecting the PV string to the inverter ($R = \text{maximum input voltage (V)} / 30\text{mA}$).
- Do not connect one PV string to more than one inverter at the same time. Otherwise, it may cause damage to the inverter.
- Photovoltaic modules used with off-grid inverters must comply with IEC 61730 Class A standard.

2.3.2 Off-grid Inverter Safety



- The voltage and frequency at the connecting point should meet the on-grid requirements.
- Additional protective devices like circuit breakers or fuses are recommended on the AC side. Specification of the protective device should be at least 1.25 times the maximum AC output current.
- For off-grid inverter with AFCI function, if the arc alarm is triggered less than 5 times within 24 hours, the alarm can be automatically cleared. After the 5th arc alarm, the off-grid inverter will shut down for protection, and the off-grid inverter can only operate

normally after the fault is solved.

- AC OUTPUT function is not recommended if the PV system is not configured with batteries. Otherwise, there may be a risk of system power outage.

2.3.3 Battery Safety

DANGER

- Keep Power Off before any operations to avoid danger. Strictly follow all safety precautions outlined in this manual and safety labels on the equipment during the operation.
- Do not disassemble, modify, or replace any part of the battery or the power control unit without official authorization from the manufacturer. Otherwise, it will cause electrical shock or damages to the equipment, which shall not be borne by the manufacturer.
- Do not hit, pull, drag, squeeze or step on the equipment or put the battery into fire. Otherwise, the battery may explode.
- Do not place the battery in a high temperature environment. Make sure that there is no direct sunlight and no heat source near the battery. When the ambient temperature exceeds 60 °C, it will cause fire.
- Do not use the battery or the power control unit if it is defective, broken, or damaged. Damaged battery may leak electrolyte.
- Do not move the battery system while it is working. Contact after-sales service if the battery shall be replaced or added.
- A short circuit in the battery may cause personal injury. The instantaneous high current caused by a short circuit can release a large amount of energy and may cause a fire.

WARNING

- If the battery discharged completely, please charge it in strict accordance with the corresponding model's user manual.
- Factors such as: temperature, humidity, weather conditions, etc. may limit the battery's current and affect its load.
- Contact after-sale service immediately if the battery is not able to be started. Otherwise, the battery might be damaged permanently.

Emergency Measures

● Battery Electrolyte Leakage



If the battery module leaks electrolyte, avoid contact with the leaking liquid or gas. The













electrolyte is corrosive. It will cause skin irritation or chemical burn to the operator. Anyone contacts the leaked substance accidentally has to do as following:



- **Breath in the leaked substance:** Evacuate from the polluted area, and seek immediate medical assistance.
- **Eye contact:** Rinse your eyes for at least 15 minutes with clean water and seek immediate medical assistance.
- **Skin contact:** Thoroughly wash the touch area with soap and clean water, and seek immediate medical assistance.
- **Ingestion:** Induce vomiting, and seek immediate medical assistance.
- **Fire**
 - The battery may explode when the ambient temperature exceeds 150°C. Poisonous and hazardous gas may be released if the battery is on fire.
 - In the event of a fire, please make sure that the carbon dioxide extinguisher or Novec1230 or FM-200 is nearby.
 - The fire cannot be put out by ABC dry powder extinguisher. Firefighters are required to wear full protective clothing and self-contained breathing apparatus.

2.4 Safety Symbols and Certification Marks

 DANGER	
<ul style="list-style-type: none"> ● All labels and warning marks should be visible after the installation. Do not cover, scrawl, or damage any label on the equipment. ● The following descriptions are for reference only. 	

No.	Symbol	Descriptions
1		Potential risks exist. Wear proper personnel protective equipment before any operations.
2		HIGH VOLTAGE HAZARD Disconnect all incoming power and turn off the product before working on it.
3		High-temperature hazard. Do not touch the product under operation to avoid being burnt.

4		Operate the equipment properly to avoid explosion.
5		Batteries contain flammable materials, beware of fire.
6		The equipment contains corrosive electrolytes. In case of a leak in the equipment, avoid contact the leaked liquid or gas.
7		Delayed discharge. Wait 5 minutes after power off until the components are completely discharged.
8		Install the equipment away from fire sources.
9		Keep the equipment away from children.
10		Do not pour with water.
11		Read through the user manual before any operations.
12		Wear personal protective equipment during installation, operation and maintaining.
13		Do not dispose of the System as household waste. Deal with it in compliance with local laws and regulations, or send it back to the manufacturer.
14		Grounding point.
15		Recycle regeneration mark.

16		CE mark
17		TUV mark
18		RCM mark

2.5 EU Declaration of Conformity

2.5.1 Equipment with Wireless Communication Modules

GoodWe Technologies Co., Ltd. hereby declares that the equipment with wireless communication modules sold in the European market meets the requirements of the following directives:

- Radio Equipment Directive 2014/53/EU (RED)
- Restrictions of Hazardous Substances Directive 2011/65/EU and (EU) 2015/863 (RoHS)
- Waste Electrical and Electronic Equipment 2012/19/EU
- Registration, Evaluation, Authorization and Restriction of Chemicals (EC) No 1907/2006 (REACH)

2.5.2 Equipment without Wireless Communication Modules

(Except Battery)

GoodWe Technologies Co., Ltd. hereby declares that the equipment without wireless communication modules sold in the European market meets the requirements of the following directives:

- Electromagnetic compatibility Directive 2014/30/EU (EMC)
- Electrical Apparatus Low Voltage Directive 2014/35/EU (LVD)
- Restrictions of Hazardous Substances Directive 2011/65/EU and (EU) 2015/863 (RoHS)
- Waste Electrical and Electronic Equipment 2012/19/EU
- Registration, Evaluation, Authorization and Restriction of Chemicals (EC) No 1907/2006

(REACH)

2.5.3 Battery

GoodWe Technologies Co., Ltd. hereby declares that batteries sold in the European market meets the requirements of the following directives:

- Electromagnetic compatibility Directive 2014/30/EU (EMC)
- Electrical Apparatus Low Voltage Directive 2014/35/EU (LVD)
- Battery Directive 2006/66/EC and Amending Directive 2013/56/EU
- Waste Electrical and Electronic Equipment 2012/19/EU
- Registration, Evaluation, Authorization and Restriction of Chemicals (EC) No 1907/2006 (REACH)

You can download the EU Declaration of Conformity on the official website:

<https://en.goodwe.com>.

3 System Introduction

3.1 System Overview

The residential smart inverter solution consists of inverter, battery system, smart dongle, etc. In the PV system, solar energy can be converted to electric energy for household needs. The IoT devices in the system controls the electrical equipment by recognizing the overall power consumption situation. So that the power will be managed in a smart way, deciding whether the power is to be used by the loads, stored in batteries, or to buy electricity from power grid, etc.

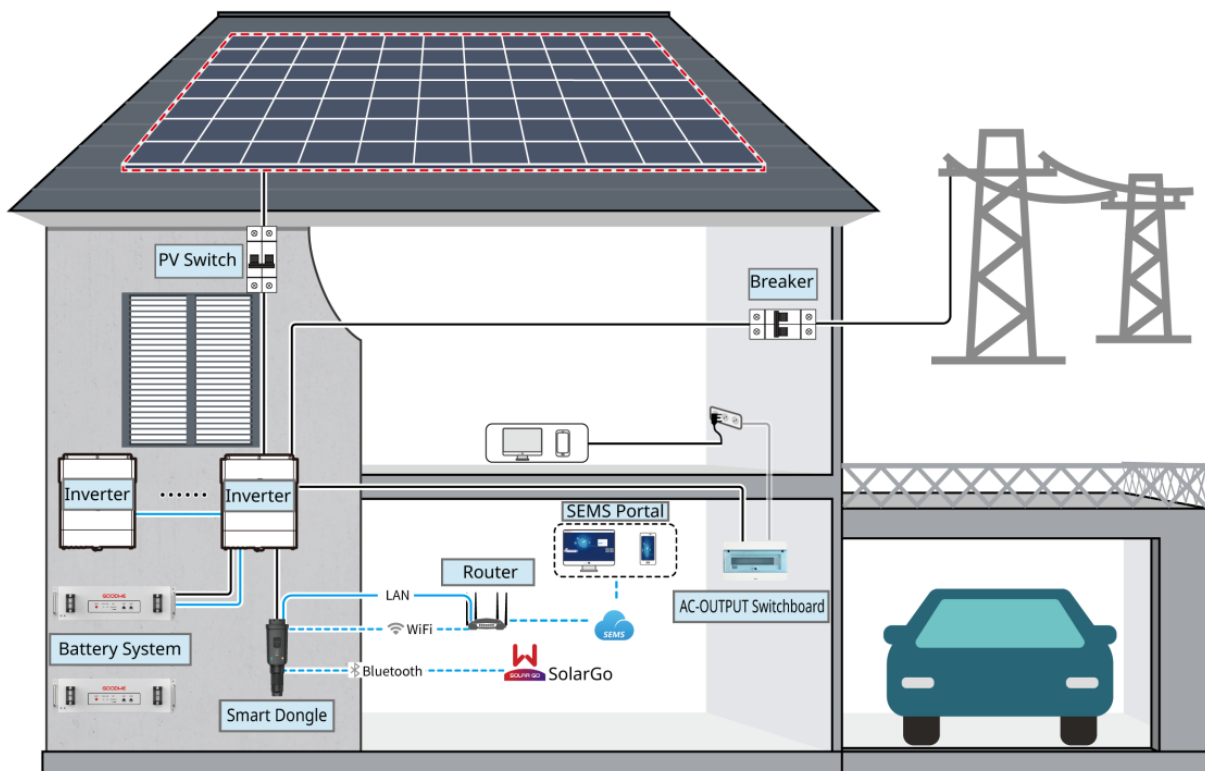

Product Type	Model	Description
Off-grid inverter	GW3500L-EO-BR GW6000-EO	<ul style="list-style-type: none"> ● In the same system, it is not supported to use different models of off-grid inverters. ● The nominal output voltage of GW3500L-EO-BR is 127V, and the nominal output voltage of GW6000-EO is 220/230V. ● A maximum of 3 inverters are supported to form a parallel system, and in single-phase to three-phase system, parallel connection of inverters are not

		supported.
Battery system	LX A5.0-10	<ul style="list-style-type: none"> ● Battery systems of different models cannot be mix used. ● LX A5.0-10: The nominal charge and discharge current of a single battery is 60A; A maximum of 15 batteries can be connected in parallel in one system.
	Lead Acid Battery	<ul style="list-style-type: none"> ● Supports connection to lead-acid batteries of AGM, GEL, and Flooded types. ● The number of batteries that can be connected in series is calculated based on the voltage of lead-acid batteries, and the total voltage of batteries connected in series is not allowed to exceed 60V.
Busbar	BCB-11-WW-0 BCB-22-WW-0 (Purchase from GoodWe)	<ul style="list-style-type: none"> ● When the charge and discharge current between battery and off-grid inverter is less than 140A, it supports direct connection between the battery and the inverter without using a busbar. For example: It supports connecting a single off-grid inverter to LX A5.0-10 without using a busbar. For detailed battery wiring methods, please refer to 6.6 Connecting the Battery Cable. ● When the charge and discharge current between battery and off-grid inverter is $\geq 140A$, a busbar or busbar box must be used to connect the inverter. (Current $\geq M \times I_{Bat}$ rated. (M: The quantity of batteries connected in parallel in the system, I_{Bat} rated: The rated current of the battery). <ul style="list-style-type: none"> ○ BCB-11-WW-0: Used with LX A5.0-10, the battery system supports a maximum working current of 360A, a working power of 18kW, can connect to a maximum of 3 off-grid inverters and 6 batteries. ○ BCB-22-WW-0: Used with LX A5.0-10, the battery system supports a maximum working current of 720A, a working power of 36kW, can connect to a maximum of 3 off-grid inverters and 12 batteries. ● Others: Prepare busbar based on actual system power and current.
Smart dongle	WiFi/LAN Kit-20	In parallel scenarios, each off-grid inverter needs to be installed with a WiFi/LAN Kit-20 dongle.

3.2 Product Overview

3.2.1 Off-grid Inverter

The off-grid inverter controls and optimizes the power in PV systems through an integrated energy management system. The power generated in the PV system can be used or stored in the battery.

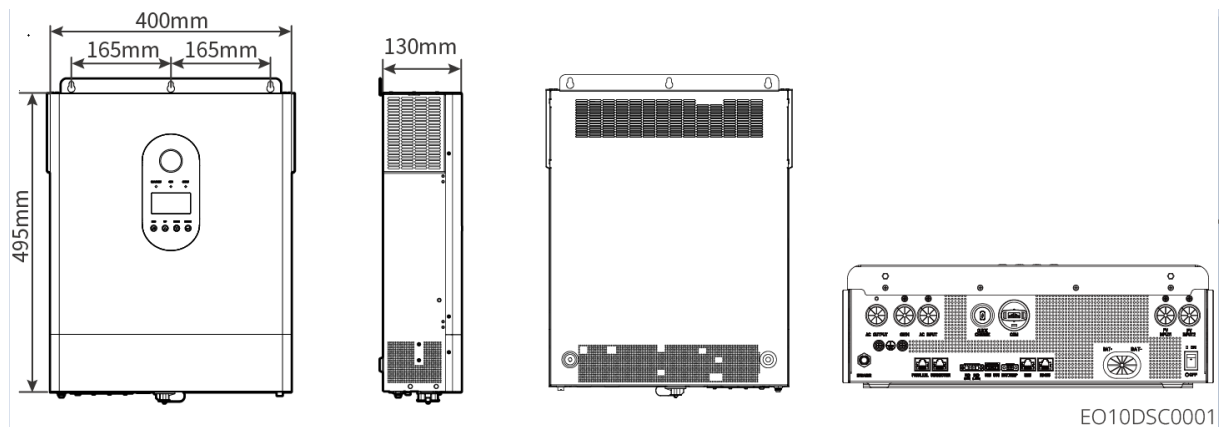

No.	Model	Nominal output power	Nominal output voltage
1	GW3500L-EO-BR	3.5kW	127V
2	GW6000-EO	6kW	220/230V

3.2.2 Battery

The battery system can store and discharge electricity according to the requirements of the PV energy storage system, and the input and output ports of the energy storage system are all low-voltage direct current.

LX A5.0-10

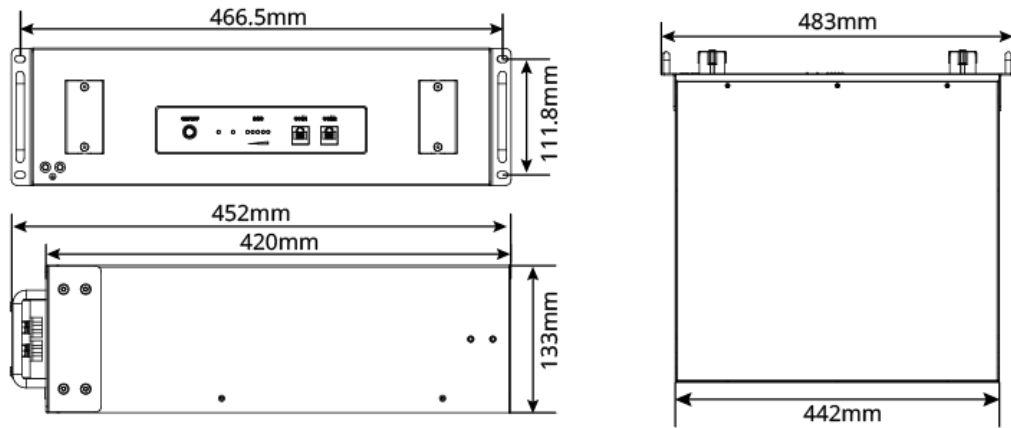

No.	Model	Number of modules	Usable energy (kWh)
1	LX A5.0-10	1	5

3.2.3 Smart Dongle

The smart dongle can transmit various power generation data to SEMS Portal, the remote monitoring platform, in real time. And connect to the SolarGo App to complete local equipment commissioning.

WiFi/LAN Kit-20

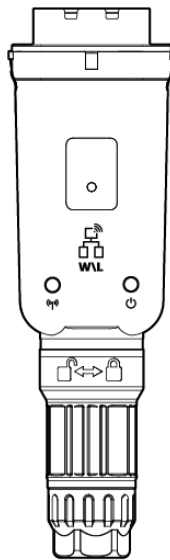

EO10DSC0002

No.	Model	Signal	Applicable scenarios
1	WiFi/LAN Kit-20	Bluetooth, WiFi, LAN	Single inverter or multiple inverters in parallel

3.3 Supported Grid Types

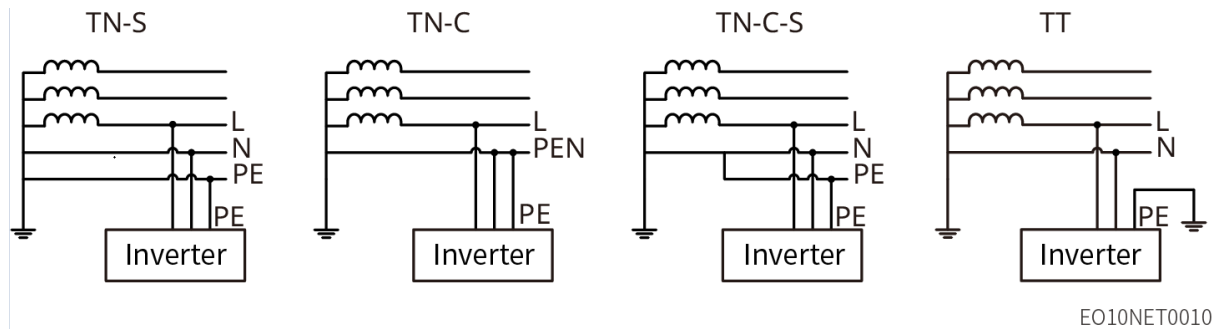

3.4 System Working Mode

Self-use Mode

- Self-use mode is the basic working mode of the system.
- When the power generated in the PV system is sufficient, it will supply the loads in priority, and the excess power will charge the batteries. When the power generated in the PV system is insufficient, the battery will supply the loads; if the battery power is also insufficient, the load will be powered by the utility grid.

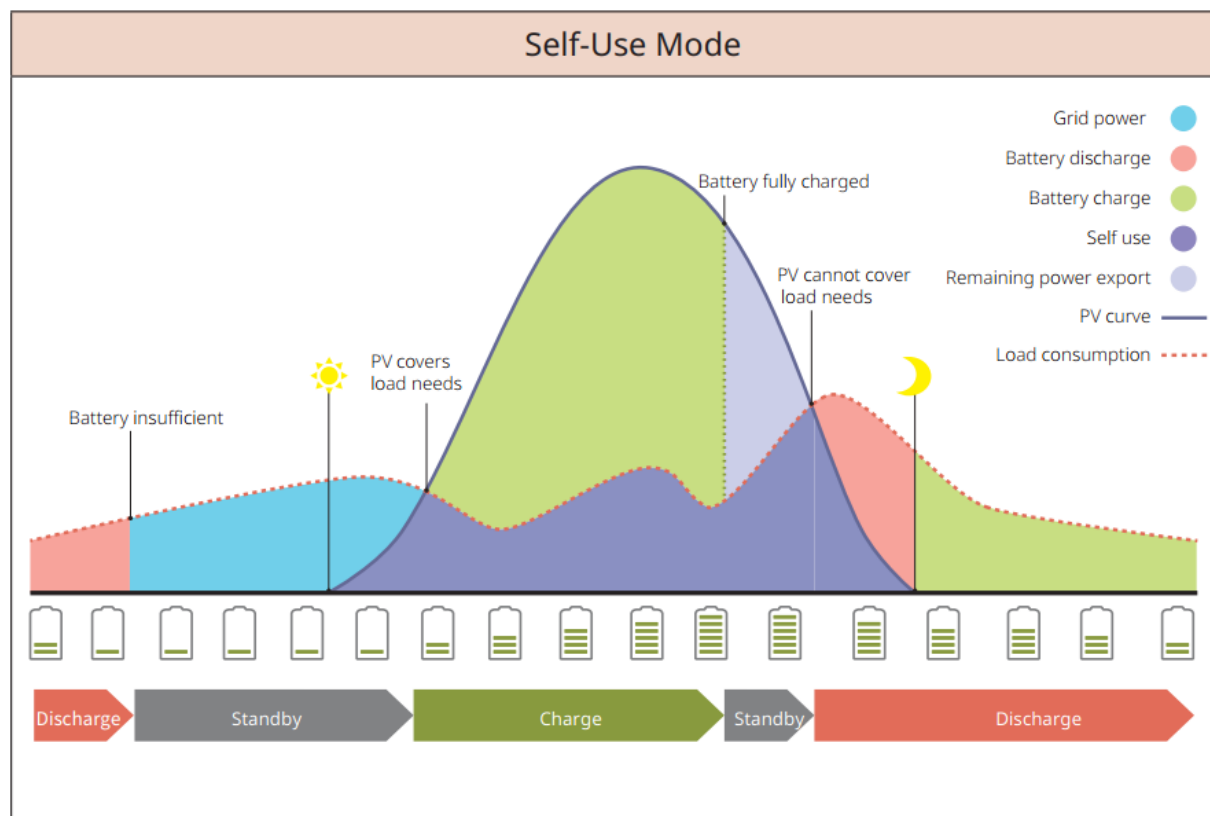

Back-up mode

- The back-up mode is mainly applied to the scenario where the grid is unstable.
- When the grid is disconnected, the inverter turns to off-grid mode and the battery will supply power to the AC OUTPUT loads; when the grid is restored, the inverter switches to grid-tied mode.
- The battery will be charged to preset SOC protection value by utility grid or PV when the system is running on-grid. So that the battery SOC is sufficient to maintain normal working when the system is off-grid. The purchase of electricity from the power grid to charge the battery must comply with local laws and regulations.

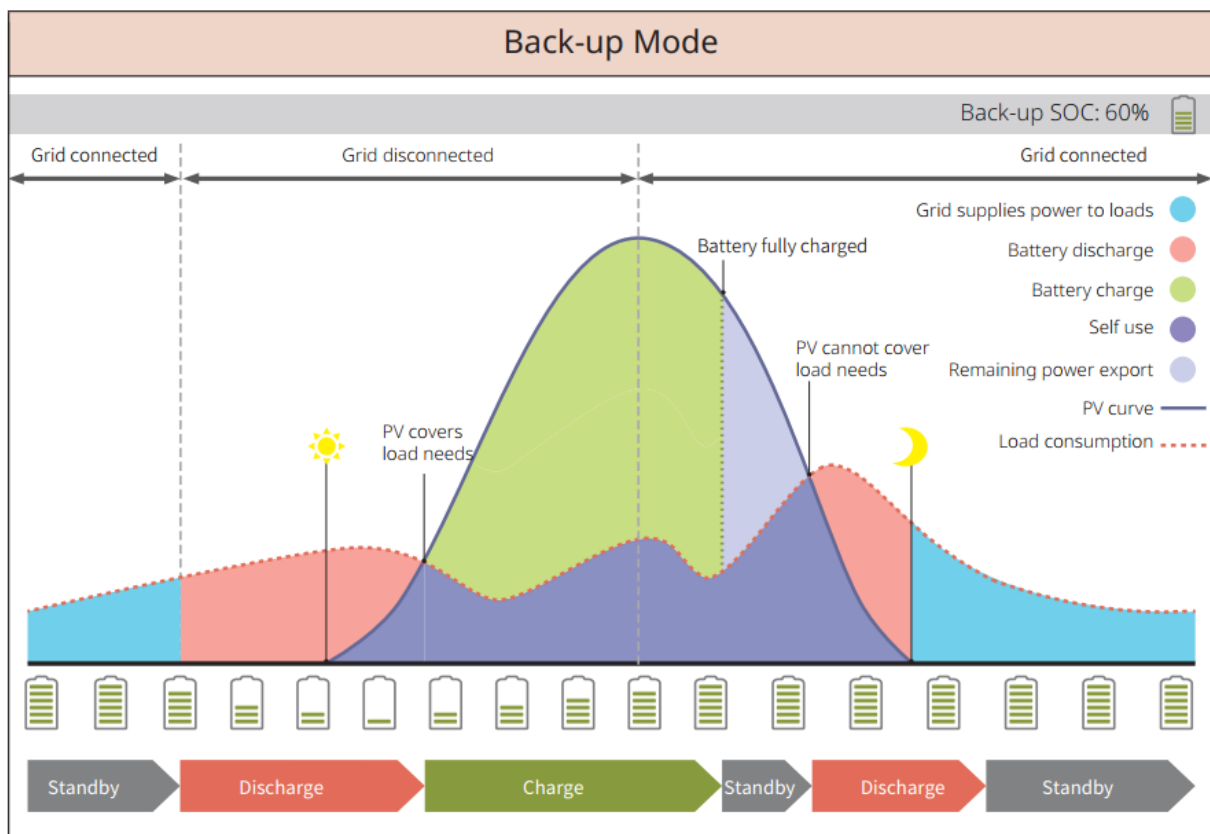

Economic mode

Under the premise of complying with local laws and regulations, the system can buy electricity from power grid based on the difference in peak and valley electricity prices; in valley price period, the system will buy electricity from the power grid; in peak price period, the system will be powered by battery.

For example, set the battery to charge mode during valley price period to charge battery with grid power. And set the battery to discharge mode during peak price period to power the load with the battery.

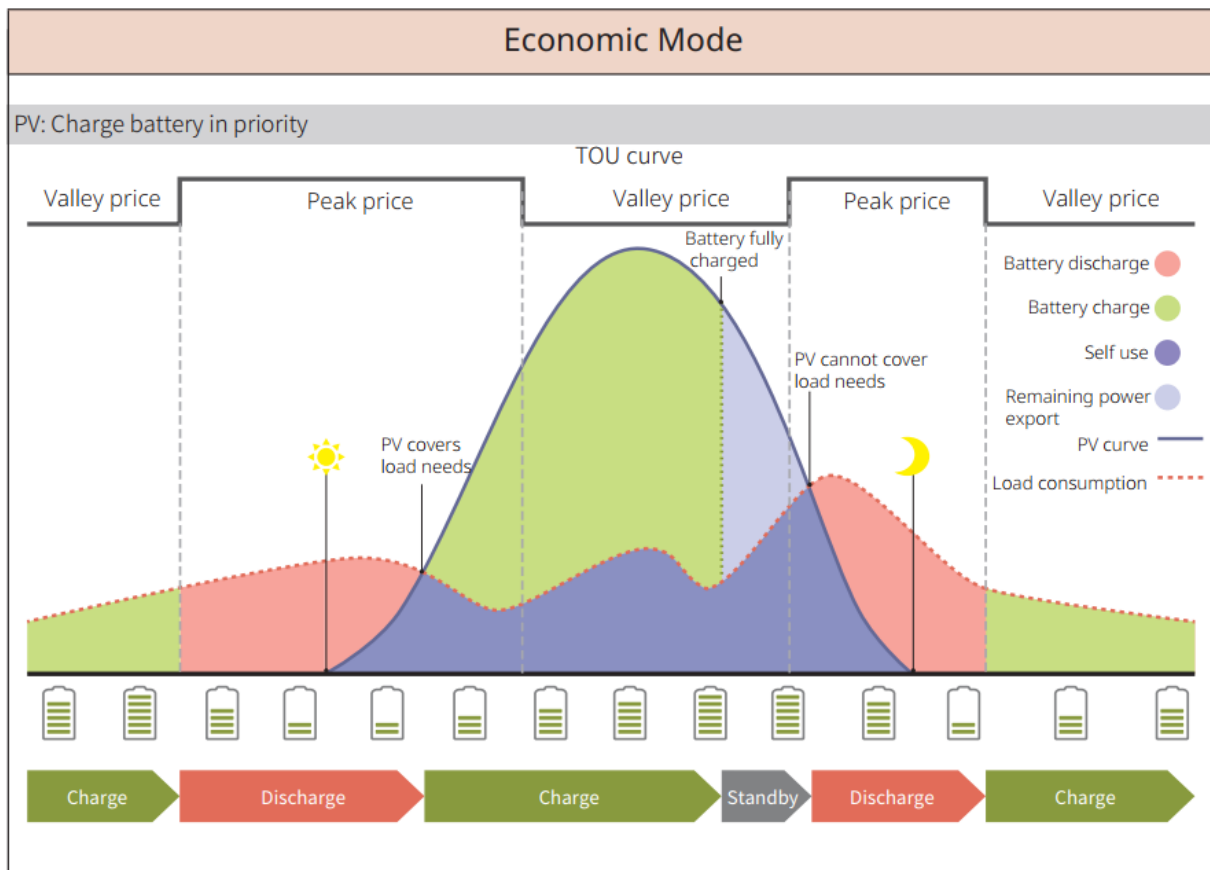

Peakshaving Mode

- Peakshaving mode is mainly applicable to industrial and commercial scenarios.
- When the total power consumption of the loads exceeds the peak shaving limit, the battery discharges to reduce the power consumption exceeds the peak shaving limit.
- When the battery SOC is lower than the preset SOC value for peakshaving, the system purchases electricity from the grid based on time periods, load electricity consumption, and buying limits of peak price.

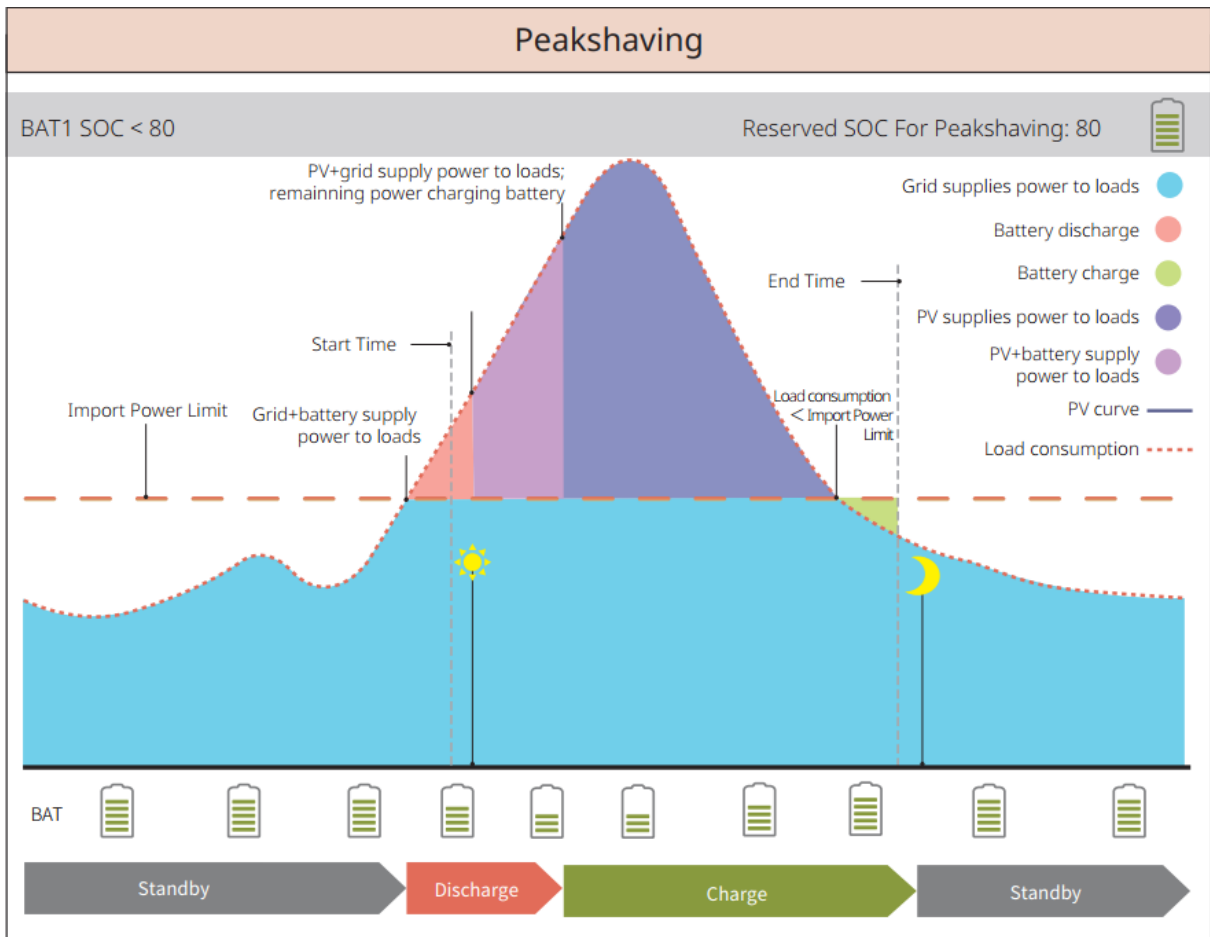

4 Check and Storage

4.1 Check before Acceptance

Check the following items before accepting the product.

1. Check the outer packing box for damage, such as holes, cracks, deformation, and other signs of equipment damage. Do not unpack the package and contact the supplier as soon as possible if any damage is found.
2. Check the product model. If the product model is not what you requested, do not unpack the product and contact the supplier.

4.2 Package Content











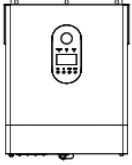
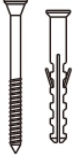

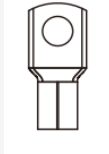
WARNING

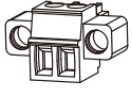
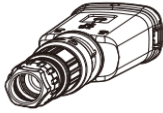
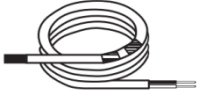
Check the deliverables for correct model, complete contents, and intact appearance. Contact the

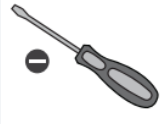









supplier as soon as possible if any damage is found.

4.2.1 Off-grid Inverter Deliverables (EO)

Parts	Description	Parts	Description
	Off-grid inverter x1		Expansion screw x4
	Protection grounding terminal x2		Battery power connection terminals x 2
	6mm ² Tubular terminal x11		4Pin communication terminal x 1
	2Pin communication terminal x 1		Smart dongle x 1
	Lead-acid battery temperature sensor cable x 1		Cross screwdriver x1
	Nut x 8		Slotted screwdriver x1
	Documents x 1		0.5mm ² Tubular terminal x6
	M3 Screw (Spare screws for installing the inverter cover) x 5		

4.2.2 Battery Deliverables (Lynx Home A)

- Battery

Parts	Description	Parts	Description
	Battery module x 1		Battery bracket x 2 (optional)
	M5 grounding screws x 2		M4*8 screw x 8 (optional)
	Terminal resistor x 1		M5 OT terminals x 2
	Documents x 1		M8 OT terminals x 4
			Electrical label x 1
	Warning label x 1		

● **Busbar box (BCB-11-WW-0) (optional)**

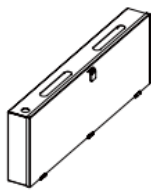
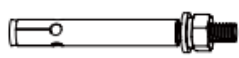
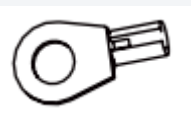

Parts	Description	Parts	Description
	360A busbar box x 1		M6 expansion bolt x 4
	M8 OT terminals x 18	-	-
	M10 OT terminal x 2		

● **Busbar box (BCB-22-WW-0) (optional)**

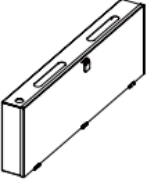
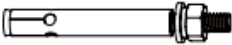
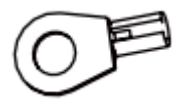
Parts	Description	Parts	Description
-------	-------------	-------	-------------

	720A busbar box x 1		M6 expansion bolt x 4
	M8 OT terminal x 36 M10 OT terminal x 6	-	-

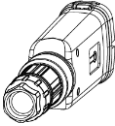
4.2.3 Smart Dongle (WiFi/LAN Kit-20)

Parts	Description	Parts	Description
	Smart dongle x 1		Documents x 1

4.3 Storage

If the equipment is not to be installed or used immediately, please ensure that the storage environment meets the following requirements: If the equipment has been long term stored, it should be checked by professionals before being put into use.

Packing requirements:

Do not unpack the outer package or throw the desiccant away.

Installation environment requirements:

1. Place the equipment in a cool place where away from direct sunlight.
2. Store the equipment in a clean place. Make sure the temperature and humidity are appropriate and no condensation. Do not install the equipment if the ports or terminals are condensed.

Battery storage temperature range (T):

- When $-20^{\circ}\text{C} \leq T < 0^{\circ}\text{C}$ or $40^{\circ}\text{C} < T \leq 45^{\circ}\text{C}$, the storage period cannot exceed 1 month.
- When $0^{\circ}\text{C} \leq T \leq 40^{\circ}\text{C}$, the storage period cannot exceed 1 year.

3. Keep the equipment away from flammable, explosive, and corrosive matters.

Stacking requirements:

1. The height and direction of the stacking inverter should follow the instructions on the packing box.
2. The off-grid inverter must be stacked with caution to prevent them from falling.

Battery Dis-/Charge Requirements:

Storage SOC: 25%-50% SOC. Circle the charge-discharge every 6 months.

5 Installation



Install and connect the equipment using the deliverables included in the package.
Otherwise, the manufacturer shall not be liable for the damage.

5.1 System Installation and Commissioning Procedure

Steps	1 Installation	2 PE	3 AC	4 Battery	5 PV	6 Communication	7 COM module
Inverter							
Tools	1 D: 50mm φ: 8mm 2 ST6.3 5N·m 	M5 3N·m 	1.6N·m 	M6 5N·m 	1.6N·m 	0.2N·m 	
Steps	1 Installation		2 PE	3 Battery		4 COM	
Battery							
Tools	M4 1.4N·m 		M6 6N·m 	M5 4N·m 		M6 6N·m 	
1 Installation			2 Commissioning				
			→		→ or		

5.2 Installation Requirements

5.2.1 Installation Environment Requirements

1. Do not install the equipment in a place near flammable, explosive, or corrosive materials.
2. The temperature and humidity at the installation site should be within the appropriate range.
3. Do not install the equipment in a place that is easy to touch, especially within children's reach.
4. 60°C high temperature exists when the equipment is working. Do not touch the surface to avoid burning.
5. Install the equipment in a sheltered place to avoid direct sunlight, rain, and snow. Build a sunshade if it is needed.
6. The place to install the equipment shall be well-ventilated for heat radiation and large for operations.
7. Check the protection rating of the equipment and ensure that the installation environment meets the requirements. The off-grid inverter and battery system can only be installed indoors.
8. Install the equipment at a height that is convenient for operation and maintenance, electrical connections, and checking indicators and labels.
9. The altitude to install the equipment shall be lower than the maximum working altitude of the system.
10. Consult the manufacturer before installing the equipment outdoors in salt affected areas. A salt affected area refers to the region within 500 meters offshore, and will be related to the sea wind, precipitation and topography.
11. Install the equipment away from electromagnetic interference. If there is any radio or wireless communication equipment below 30MHz near the equipment, you have to:
 - Off grid inverter: Add a multi-turn winding ferrite core at the DC input or AC output cable of the inverter, or add a low-pass EMI filter or make sure that the distance between off-grid inverter and wireless electromagnetic interference device exceeds 30m.
 - Other equipment: The distance between the equipment and the wireless EMI equipment should be more than 30m.

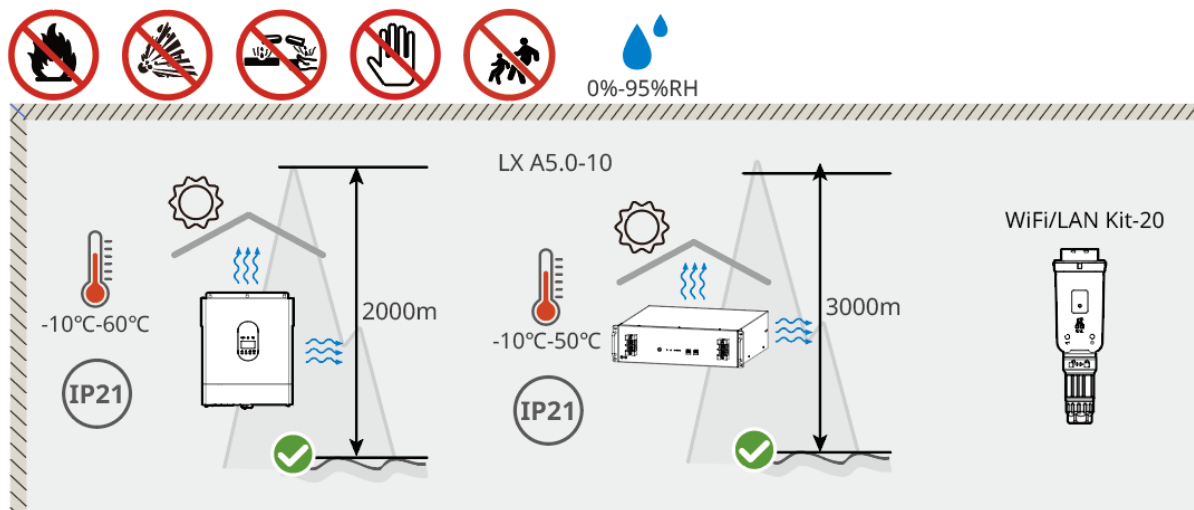

5.2.2 Installation Space Requirements

Reserve enough space for operations and heat dissipation when installing the system. When using CAT7 communication cables among inverters, the maximum distance can reach 10 meters, while using CAT5 communication cables, the maximum distance can reach 5 meters.

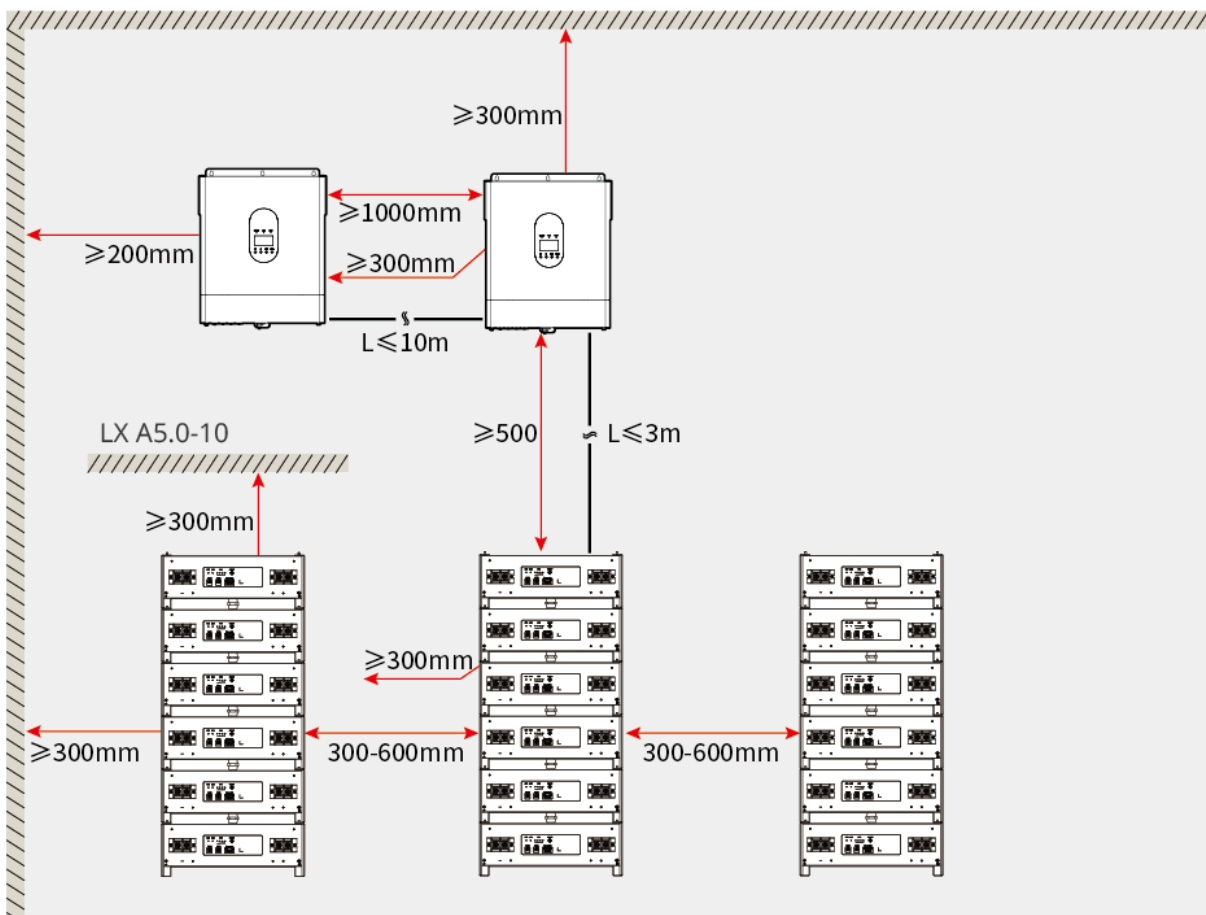



5.2.3 Tool Requirements

NOTICE

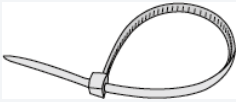

The following tools are recommended when installing the equipment. Use other auxiliary tools on site if necessary.

Installation Tools

Tool	Description	Tool	Description
	Diagonal pliers		RJ45 crimping tool
	Wire stripper		YQK-70 hydraulic pliers
	Adjustable wrench		PV connector tool PV-CZM-61100
	Impact drill (drill bits Φ8mm, 10mm)		Torque wrench M4、 M5、 M6、 M8、 M10
	Rubber hammer		Socket wrench set
	Marker		Multimeter Range ≤600V
	Heat shrink tube		Heat gun

	Cable tie		Vacuum cleaner
	Level tool	-	-

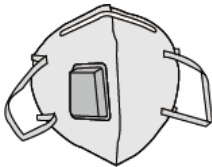
Personal Protective Equipment

Tool	Description	Tool	Description
	Insulation gloves and safety gloves		Dust mask
	Goggles		Safety shoes

5.3 Equipment Handling

CAUTION

- Operations such as transportation, turnover, installing and so on must meet the requirements of local laws and regulations.
- Move the equipment to the site before installation. Follow the instructions below to avoid personal injury or equipment damage.
 1. Consider the weight of the equipment before moving it. Assign enough personnel to move the equipment to avoid personal injury.
 2. Wear safety gloves to avoid personal injury.
 3. Keep balance to avoid falling down when moving the equipment.

5.4 Installing the Off-grid Inverter

CAUTION

- Avoid the water pipes and cables buried in the wall when drilling holes.
- Wear goggles and a dust mask to prevent the dust from being inhaled or contacting eyes when drilling holes.
- Make sure the off-grid inverter is firmly installed in case of falling down.

Step 1: Remove the off-grid inverter cover to expose the mounting holes.

Step 2: Measure the drilling position on the wall with a ruler and a level tool.

Step 3: Drill holes using an impact drill.

Step 4: Use screws to securely fasten the inverter to the wall, ensuring the installation of the inverter is stable.

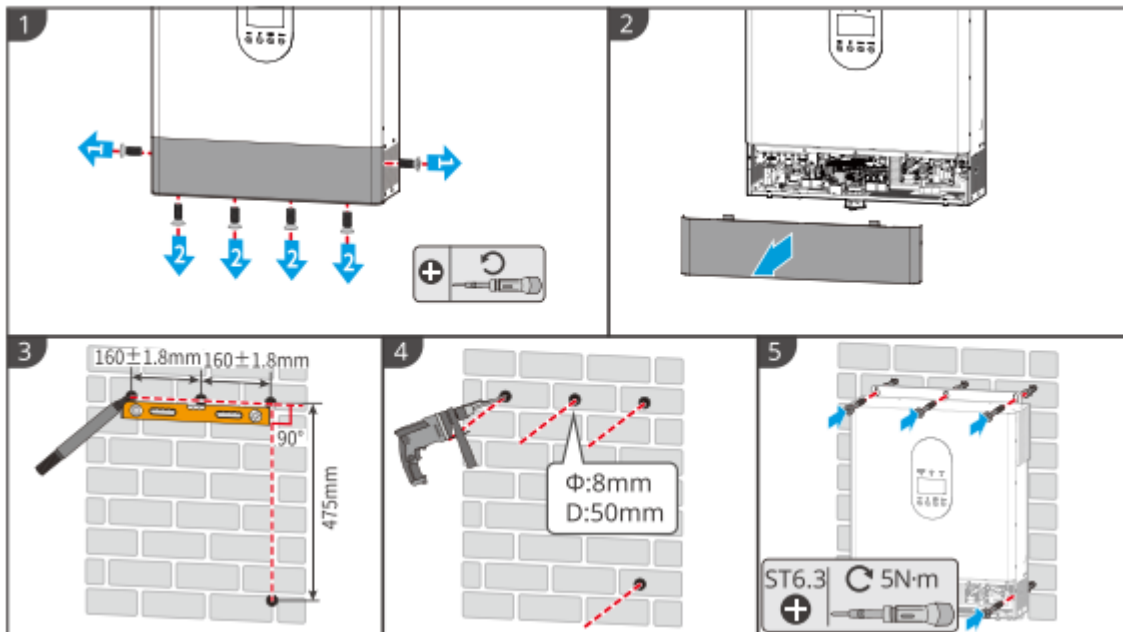

5.5 Installing the Battery System

! WARNING

- Ensure that the battery system is installed vertically and securely. When using the locking bracket, the bracket should be vertically attached to the wall and the surface of the battery system.
- Cover the equipment with a cardboard to prevent foreign matters when drilling holes. Otherwise, the system may be damaged.
- After marking the drilling position with a marker pen, the battery system needs to be moved away to avoid equipment damage caused by the impact drill when drilling.
- Cover the equipment with a cardboard to prevent foreign matters when drilling holes. Otherwise, the system may be damaged.

LX A5.0-10: Stacking Installation

NOTICE

Up to 6 batteries can be stacked for stacking installation.

Step 1: Place the battery vertically, install the bracket in the bottom and secure it with screws.

Step 2: Remove the handles and install another brackets and secure it with screws.

Step 3: Place the batteries flat, and then stack and install multiple batteries.

- Insert the locating pins on the bracket into the locating holes at the lower bracket.

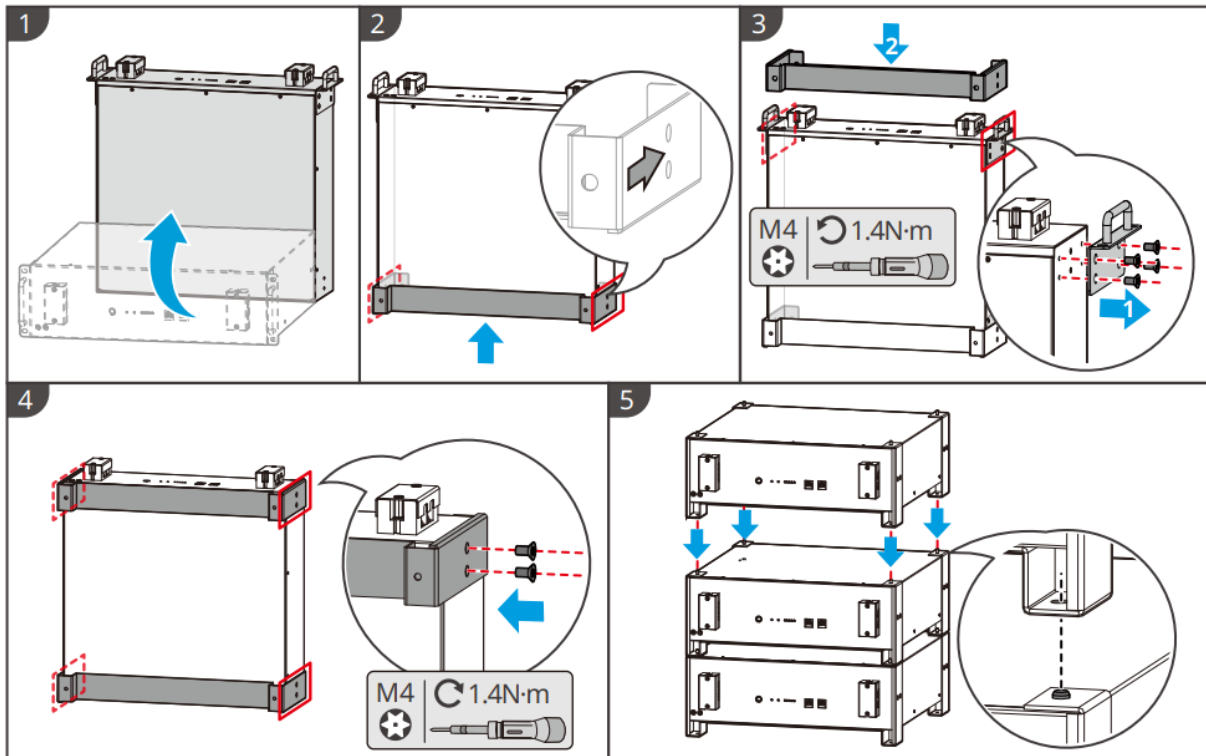

LX A5.0-10: Rack-mount Installation

NOTICE

- It is recommended to use a 19-inch standard rack with physical length and width selectable as 600*800mm and above. The height can be chosen according to the number of batteries in parallel.
- For rack mount, electrical labels and warning labels need to be attached to any position of the front panel of the battery (these labels are shipped as additional accessories).

Step 1: Stick the electrical label and warning label to the position of the front panel of any battery.

Step 2: Place the battery on the guide rail of the rack and secure the battery to the rack with screws from the handle.

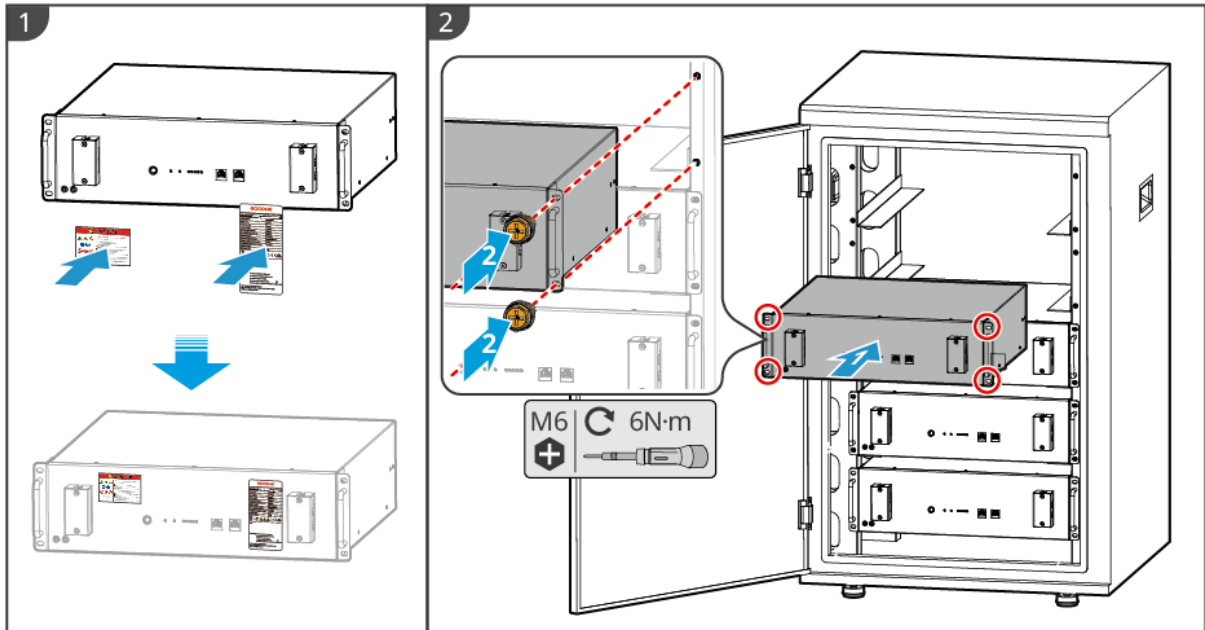

LXA10INT0002

6 System Wirings

DANGER

- Perform electrical connections in compliance with local laws and regulations. Including operations, cables, and component specifications.
- Disconnect the DC switches and the AC output switches to power off the equipment before any electrical connections. Do not work with power on. Otherwise, an electric shock may occur.
- Tie the same type cables together, and place them separately from cables of different types. Do not place the cables entangled or crossed.
- If the cable bears too much tension, the connection may be poor. Reserve a certain length of the cable before connecting it to the Inverter cable port.
- Make sure that the cable conductor is in full contact with the terminal and the cable insulation part is not crimped with the terminal when crimping the terminal. Otherwise, the device may not be able to work properly, or the connection may be unreliable during working, which may cause terminal block damage, etc.

NOTICE

- Wear personal protective equipment like safety shoes, safety gloves, and insulating gloves during electrical connections.
- All electrical connections should be performed by qualified professionals.

- Cable colors in this document are for reference only. The cable specifications shall meet local laws and regulations.
- For parallel systems, follow the safety precautions in the user manuals of related products in the system.

6.1 System Wiring Diagram

NOTICE

- N and PE cables of the AC INPUT and AC OUTPUT ports of the inverter are different based on the regulation requirements of different regions. Refer to the specific requirements of local regulations.
- The off-grid inverter has built-in relays for AC INPUT and AC OUTPUT ports. When the inverter is in the off-grid mode, the built-in AC INPUT relay is open; while when the inverter is in grid-tied mode, it is closed.
- When the off-grid inverter is powered on, the AC OUTPUT port is energized. Power off the inverter first if maintenance is required on the AC OUTPUT loads. Otherwise, it may cause electric shock.

N and PE cables are separately wired in the Main Panel

NOTICE

- Ensure that the PE cable of AC OUTPUT is correctly connected and secured, otherwise the AC OUTPUT function may be abnormal in the event of a grid fault.
- The following diagram is applicable to areas except Australia or New Zealand.

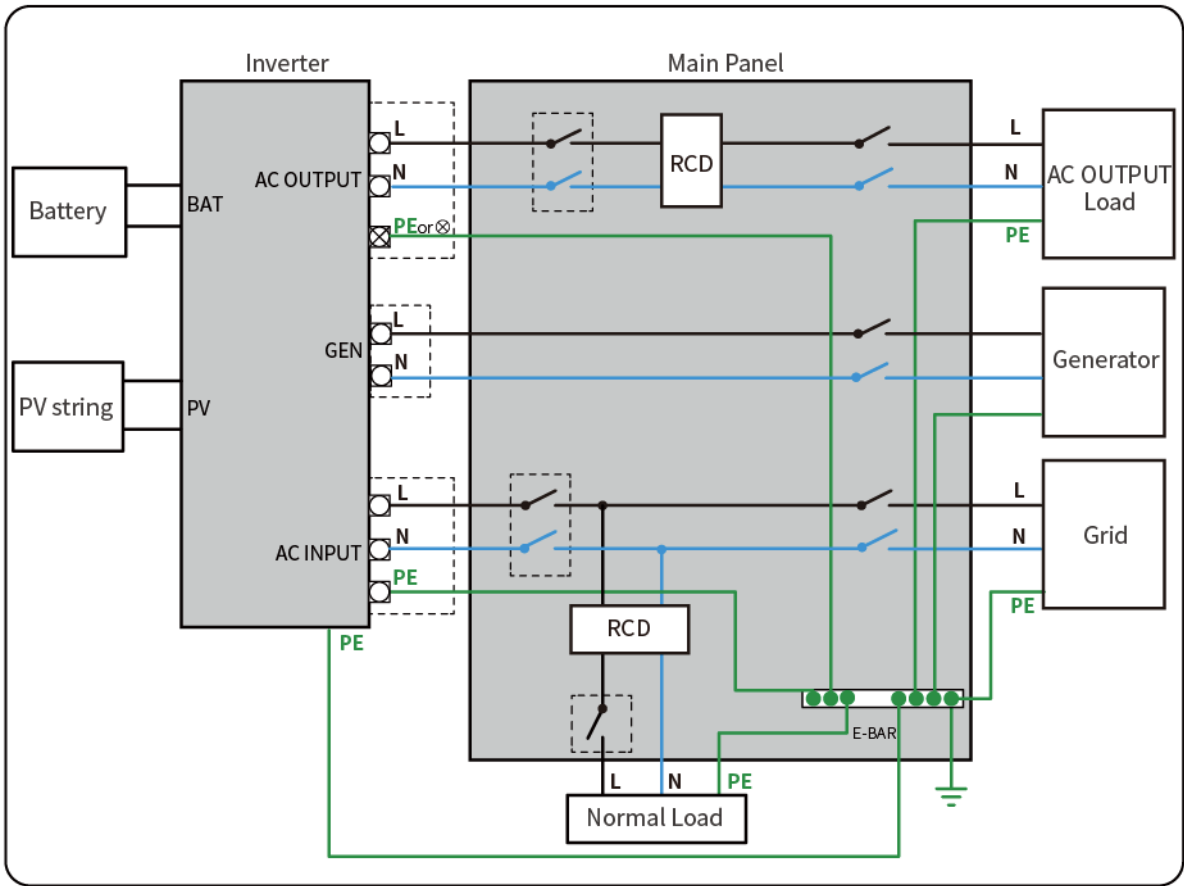

EO10NET0009

6.2 Detailed System Wiring Diagram

6.2.1 Single Inverter System Wiring Diagram

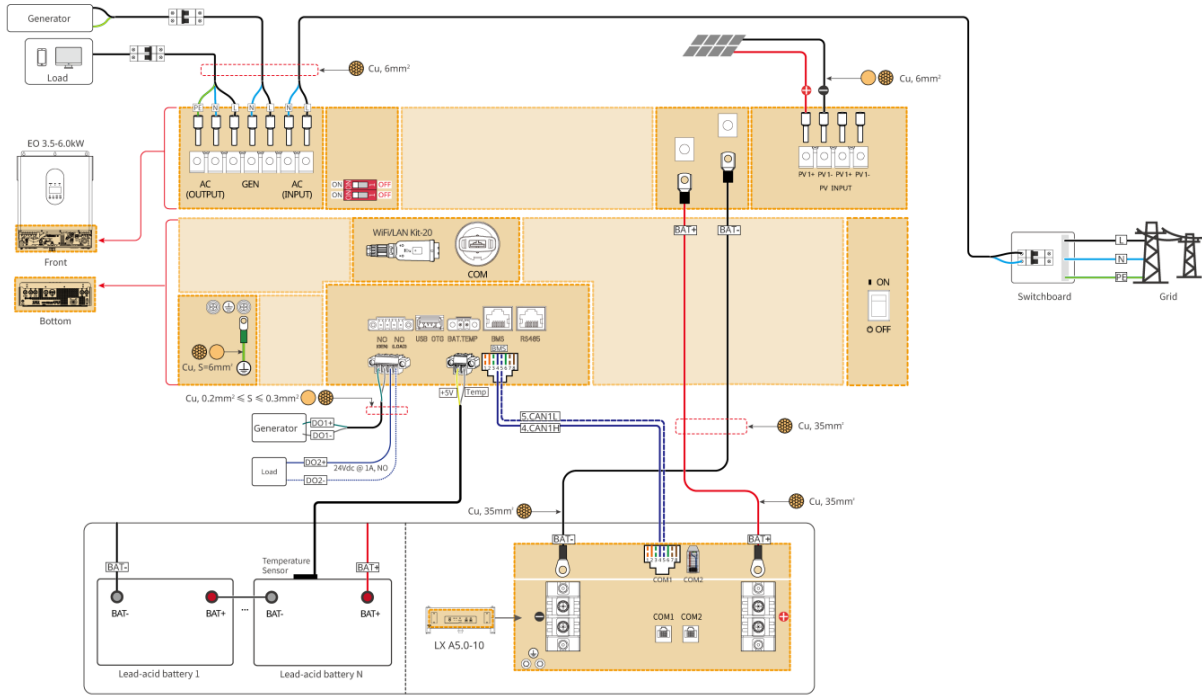

6.2.2 Single-phase Parallel System Wiring Diagram

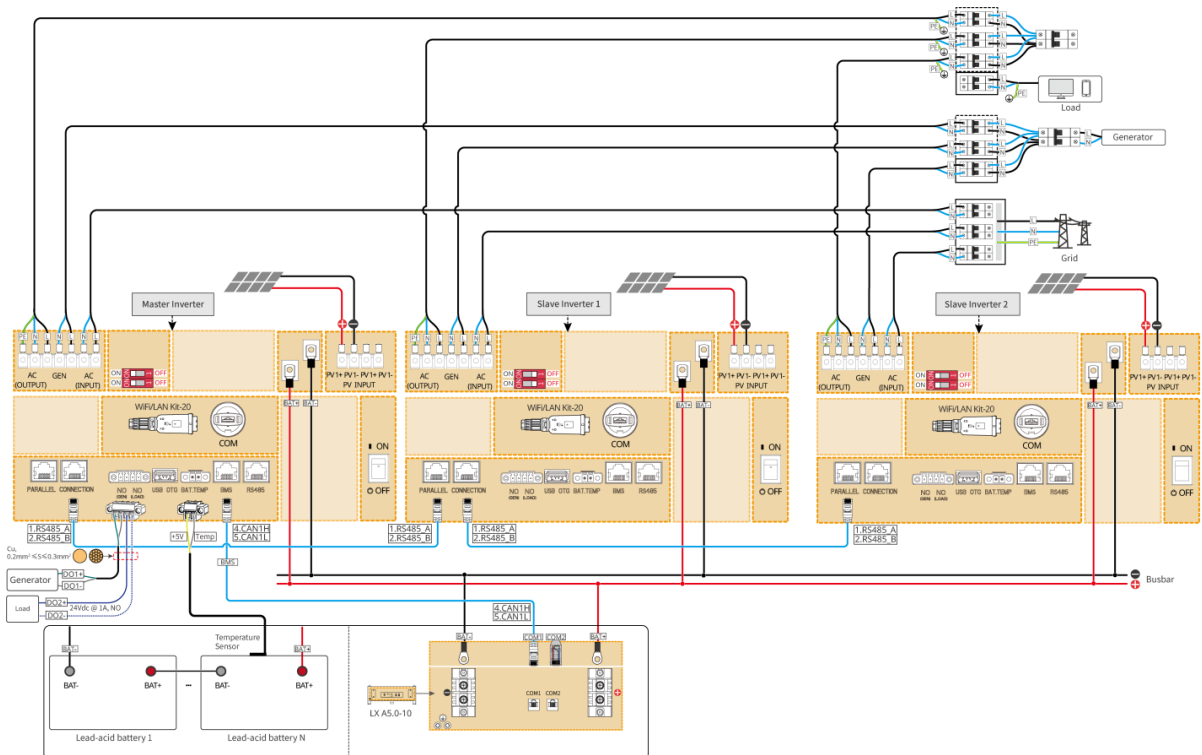

6.2.3 Three-phase System Wiring Diagram

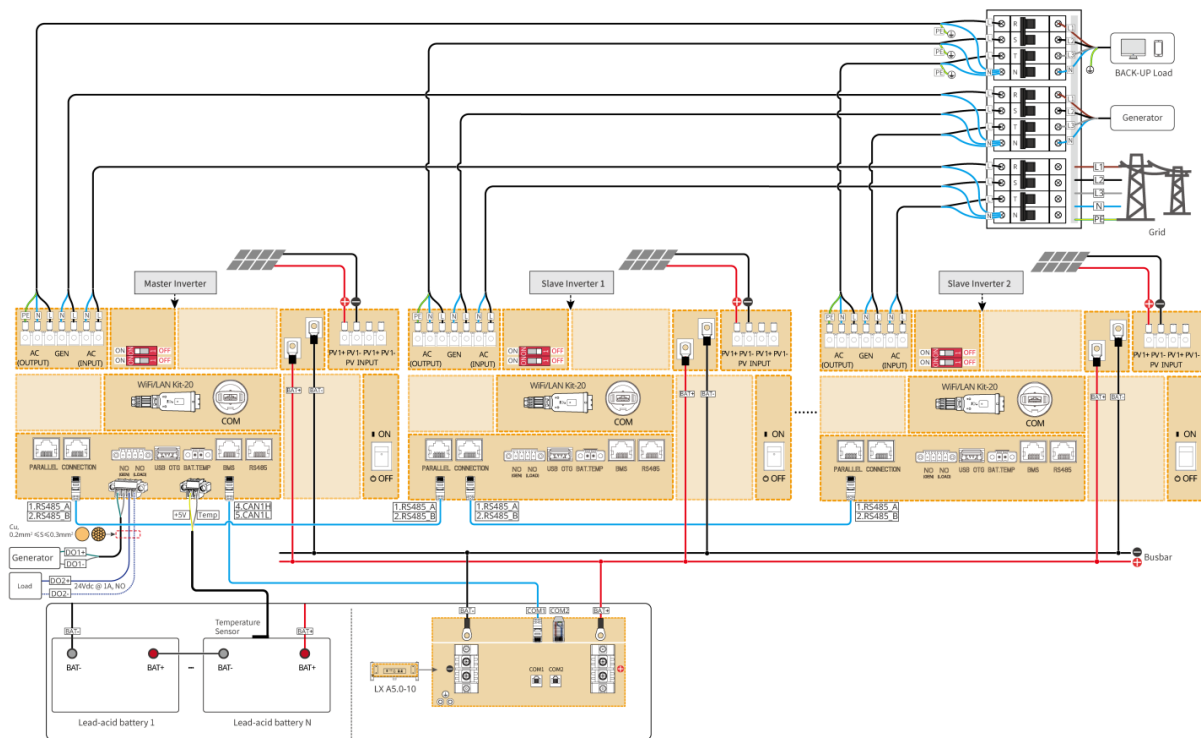

6.3 Preparing Materials



- Do not connect loads between inverter and AC switch directly connected to the inverter.
- Install one AC output circuit breaker for each inverter. Multiple inverters cannot share one AC circuit breaker. Prepare switchboard according to the number of inverters.
- An AC circuit breaker shall be installed on the AC side to make sure that the inverter can safely disconnect the grid when an exception happens. Select the appropriate AC circuit breaker in compliance with local laws and regulations.
- When the inverter is powered on, the AC OUTPUT port is energized. Power off the inverter first if maintenance is required on the AC OUTPUT loads. Otherwise, it may cause electric shock.
- In the same system, it is recommended to use cables with consistent conductor material, cross sectional area, length, etc.
 - The AC cable for AC OUTPUT port of each inverter
 - The AC cable for AC INPUT port of each inverter
 - The AC cable for generator port of each inverter

- The power cable between inverter and battery.
- The power cable between batteries
- The power cable between inverter and busbar
- The power cable between battery and busbar

6.3.1 Preparing Breakers

No.	Circuit breaker	Recommended specifications	Comment
1	AC OUTPUT breaker	<ul style="list-style-type: none"> ● Single inverter system, single-phase parallel system: nominal current \geq 40A, nominal voltage \geq 230V. ● Single-phase to three-phase: nominal current \geq 40A, nominal voltage \geq 400V. 	Prepared by customers.
2	GEN load breaker		Prepared by customers.
3	AC INPUT breaker		Prepared by customers.
4	Battery breaker	Nominal current \geq 165A, nominal voltage \geq 60V.	Prepared by customers.
5	PV switch	Nominal current \geq 35A, nominal voltage \geq 550V	Prepared by customers.

6.3.2 Preparing Cables

No.	Cable	Recommended specifications	Obtain method
1	Inverter PE cable	<ul style="list-style-type: none"> ● Single-core outdoor copper cable ● Conductor cross-sectional area: $S=6\text{mm}^2$ 	Prepared by customers.
2	Battery PE cable	<ul style="list-style-type: none"> ● Single-core outdoor copper cable ● Conductor cross-sectional area: $4\text{mm}^2\text{-}6\text{mm}^2$ 	Prepared by customers.
3	PV DC cable	<ul style="list-style-type: none"> ● Commonly used outdoor photovoltaic cable 	Prepared by customers.

		<ul style="list-style-type: none"> ● Conductor cross-sectional area: 6mm² ● Outer diameter: 5mm 	
4	Battery DC cable	<ul style="list-style-type: none"> ● Single-core outdoor copper cable ● Conductor cross sectional area: Recommend 35mm² between inverter and battery; recommend 25mm² between batteries. ● Outer diameter: 15.7mm-16.7mm 	Prepared by customers.
5	AC cable	<ul style="list-style-type: none"> ● Single-core outdoor copper cable ● Conductor cross-sectional area: 6mm² ● Outer diameter: 5mm 	Prepared by customers.
6	BMS communication cable Parallel system communication cable Communication cable for battery parallel connection	CAT 5E and above shielded network cable and RJ45 shielded connector	Prepared by customers.
7	Dry contact communication cable	Shielded twisted pair cable Conductor cross-sectional area: 0.2mm ² -0.4mm ²	Prepared by customers.

6.4 Connecting the PE cable



WARNING

- The PE cable connected to the enclosure of the inverter cannot replace the PE cable connected to the AC output port. Make sure that both of the two PE cables are securely connected.
- Make sure that all the grounding points on the enclosures are equipotentially

connected when there are multiple inverters.

- To improve the corrosion resistance of the terminal, you are recommended to apply silica gel or paint on the ground terminal after installing the PE cable.
- The PE cable should be prepared by the customer.

Inverter

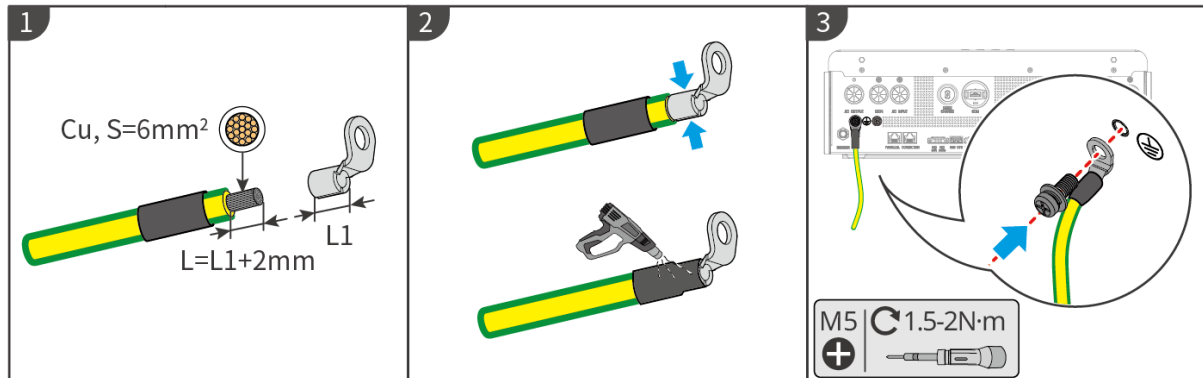

EO10ELC0001

Battery system

NOTICE

- Connect the PE cable first before installing the equipment. Disconnect the PE cable after dismantling the equipment.

Battery grounding for LX A5.0-10

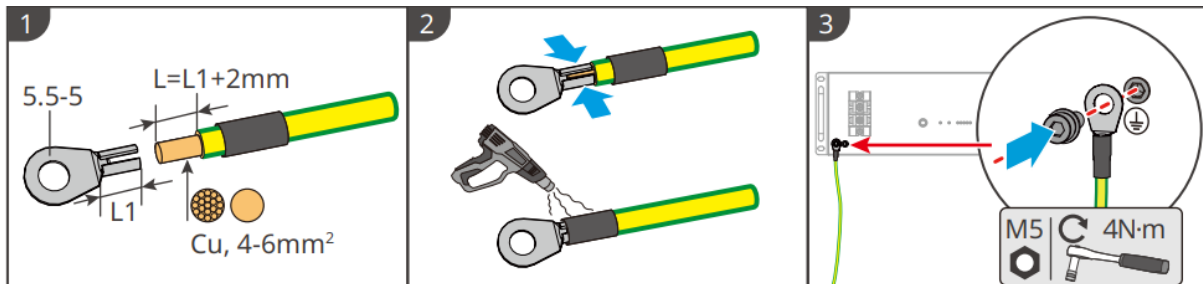

6.5 Connecting the PV Cable

DANGER

- Do not connect one PV string to more than one inverter at the same time. Otherwise, it may cause damage to the inverter.
- Confirm the following information before connecting the PV string to the inverter. Otherwise, the inverter may be damaged permanently or even cause fire and cause personal and property losses.

1. Make sure that the max short circuit current and the max input voltage per MPPT are within the permissible range.
2. Make sure that the positive pole of the PV string connects to the PV+ of the inverter. And the negative pole of the PV string connects to the PV- of the inverter.

! WARNING

- The PV strings cannot be grounded. Ensure the minimum insulation resistance of the PV string to the ground meets the minimum insulation resistance requirements before connecting the PV string to the inverter ($R = \text{maximum input voltage} / 30\text{mA}$).
- Ensure the DC cables are connected tightly, securely and correctly.
- Measure the DC cable using the multimeter to avoid reverse polarity connection. Also, the voltage should be within the permissible range.

NOTICE

The two input strings per MPPT should be of the same type, the same number of modules, the same tilt and angle to ensure the best efficiency.

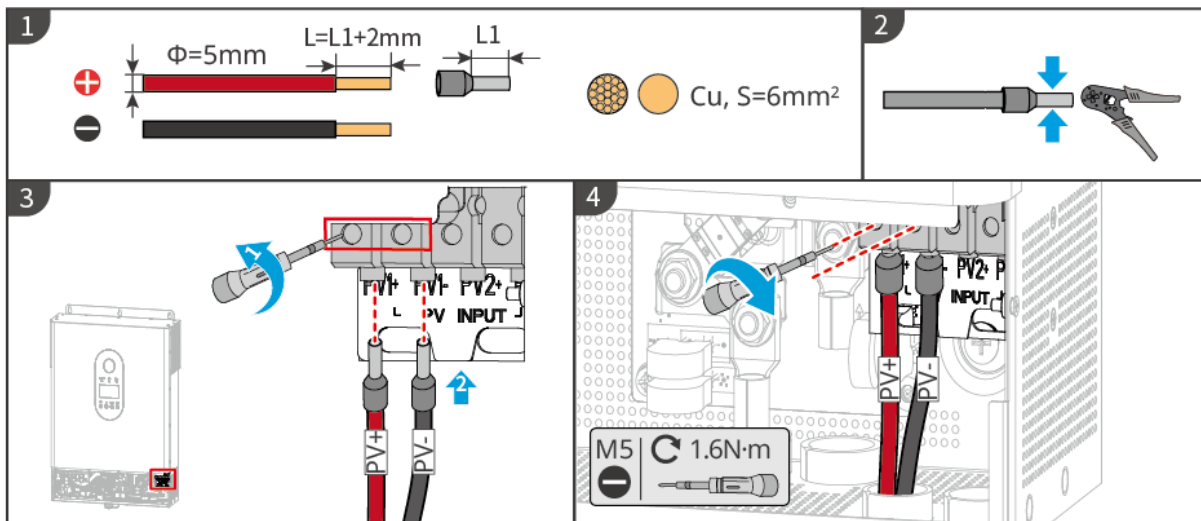

6.6 Connecting the Battery Cable

! DANGER

- In a single inverter system, do not connect the same battery pack to multiple inverters, which may cause inverter damage.
- It is forbidden to connect loads between inverter and batteries.
- When connecting battery cables, use insulated tools to prevent accidental electric shock or short circuit to the batteries.

- Ensure that the open circuit voltage of the battery is within the permissible range of the inverter.
- Install a DC switch between the inverter and the battery in compliance with local laws and regulations.

Battery system wiring diagram

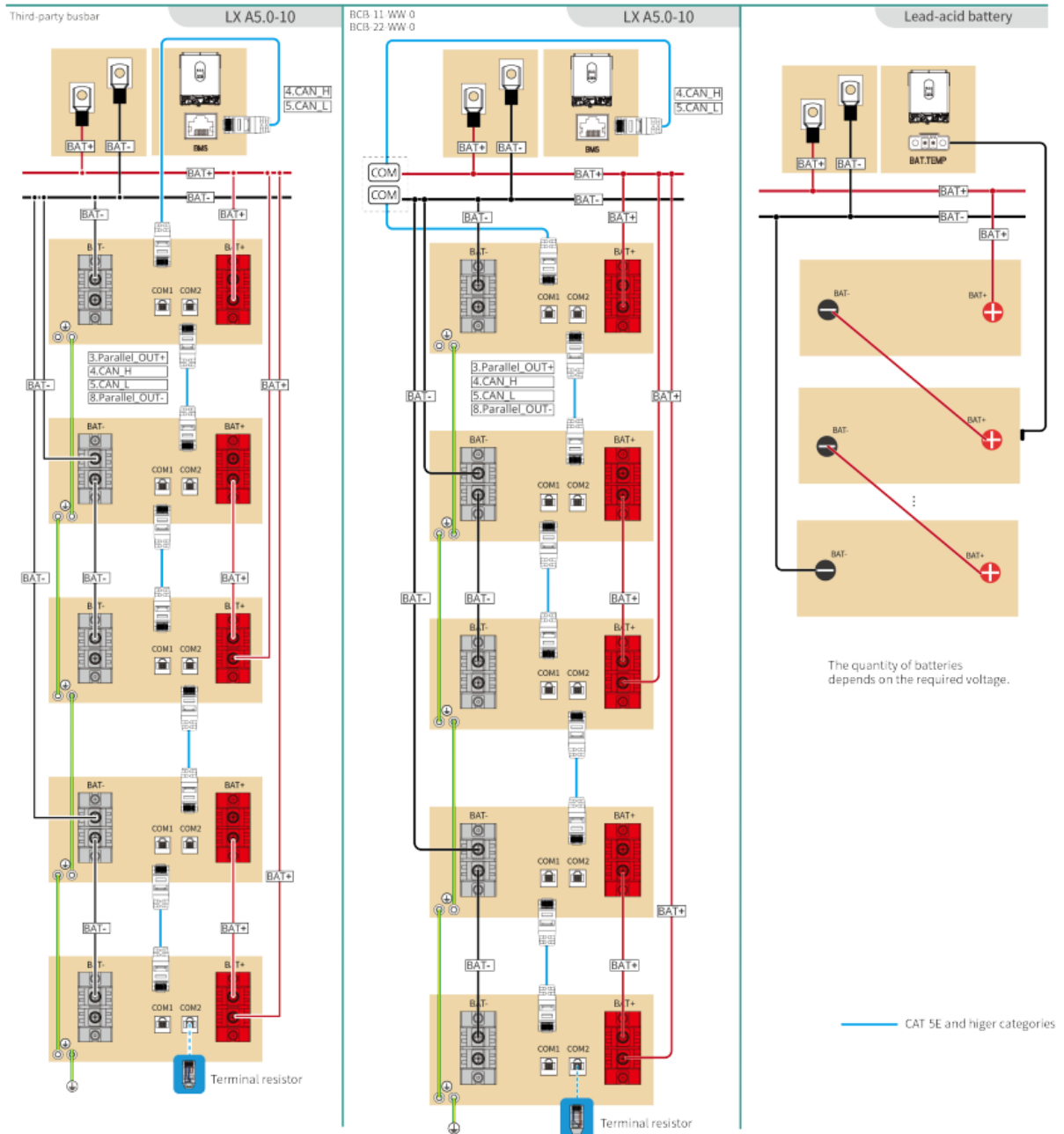

LX A5.0-10: Hand to hand connection

- The nominal charge and discharge current of a single battery is 60A.
- The battery system supports a maximum working current of 120A, a working power of 6kW, and can connect to 1 off-grid inverter, and 2 batteries.

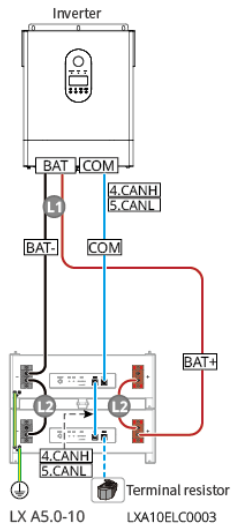

LX A5.0-10: Used with busbar BCB-11-WW-0.

- The nominal charge and discharge current of a single battery is 60A.
- The battery system supports a maximum working current of 360A, a working power of 18kW, and can connect to a maximum of 3 off-grid inverters, and 6 batteries.

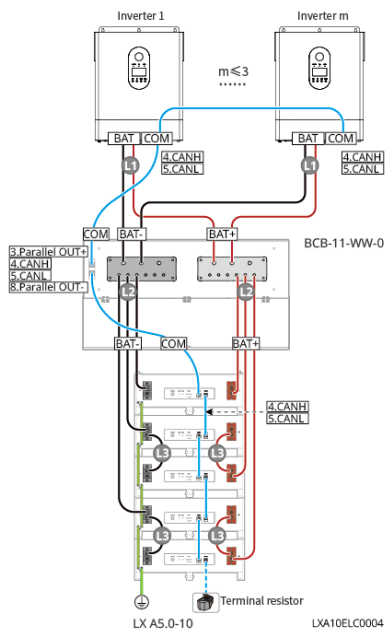

LX A5.0-10: Used with busbar BCB-22-WW-0.

- The nominal charge and discharge current of a single battery is 60A.
- The system supports a maximum working current of 720A, a working power of 36kW, and can connect to a maximum of 3 off-grid inverters, and 12 batteries.

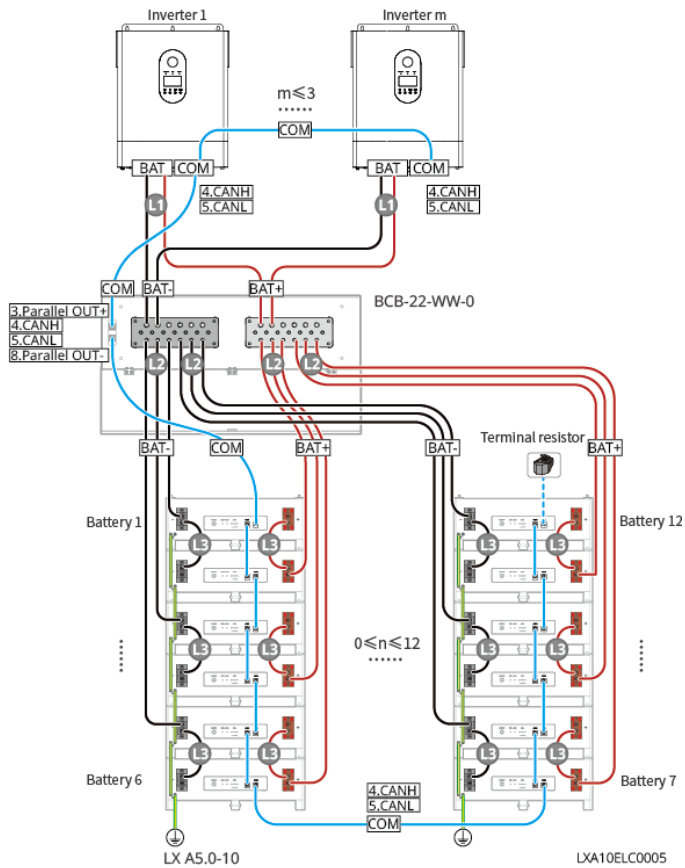

LX A5.0-10: Used with third-party busbar connection method

- The nominal charge and discharge current of a single battery is 60A.
- The battery system supports a maximum working current of 900A, a working power of 45kW, and can connect to a maximum of 3 off-grid inverters, and 15 batteries.

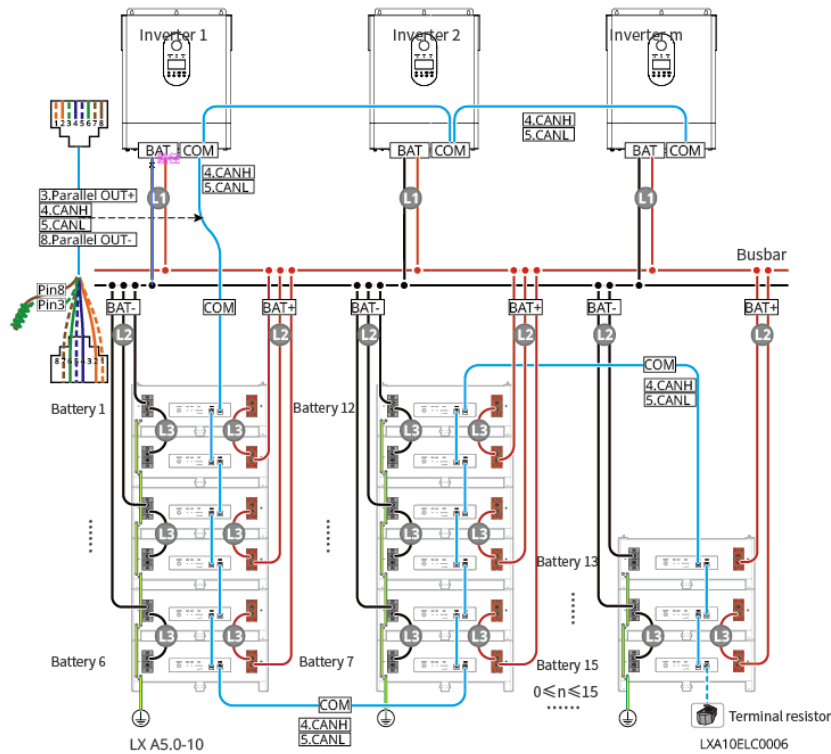

Connection instructions for BMS communication between off-grid inverter and battery

Inverter port	Connected to the battery port	Port definition	Description
BMS(CAN)	COM1	4: CANH1 5: CANL1	<ul style="list-style-type: none"> The inverter communicates with the battery through CAN. Connect the BMS1 port of the inverter to COM1 port of the battery.

Connection instructions for batteries in parallel

LX A5.0-10 Communication port definition

PIN	COM1	COM2	Description
1	-	-	Reserved
2	-	-	

3	Parallel OUT+	Parallel OUT+	Parallel communication port
4	CAN_1H	CAN_1H	Connect the inverter communication port or battery parallel communication port.
5	CAN_1L	CAN_1L	
6	-	-	Reserved
7	-	-	
8	Parallel OUT-	Parallel OUT-	Parallel communication port

6.6.1 Connecting the Power Cable between Inverter and Battery

WARNING

- Measure the DC cable using the multimeter to avoid reverse polarity connection. Also, the voltage should be within the permissible range.
- Connect the battery cables to the corresponding terminals such BAT+, BAT- and grounding ports correctly. Otherwise, it will cause damage to the inverter.
- Ensure that the whole cable cores are inserted into the terminal holes. No part of the cable core can be exposed.
- Ensure that the cables are connected securely. Otherwise it will cause damage to the inverter due to overheat during its operation.
- Do not connect one battery pack to more than one inverter at the same time. Otherwise, it may cause damage to the inverter.

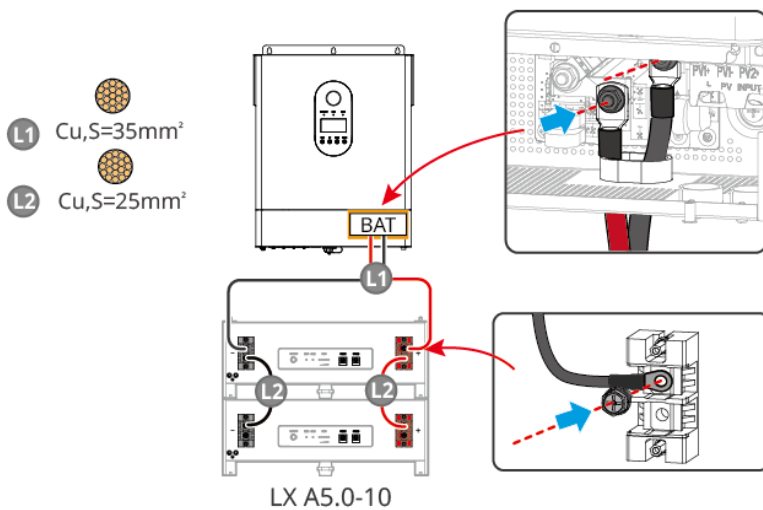

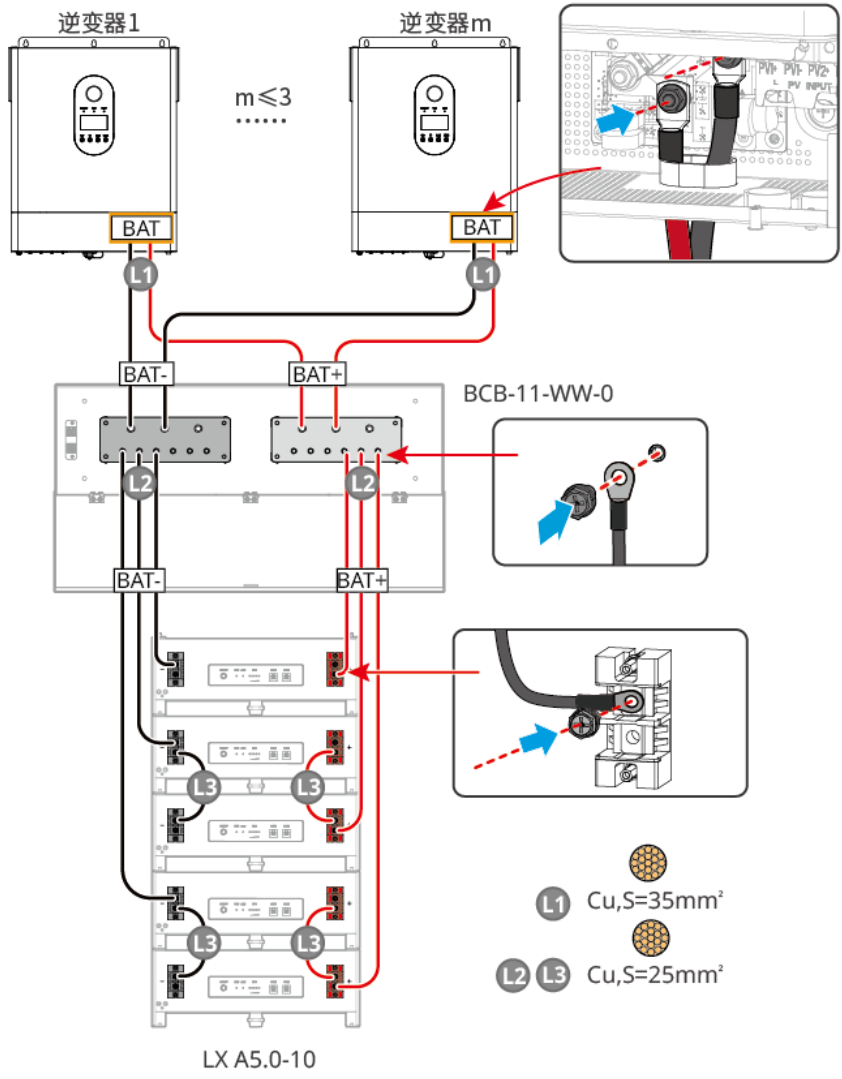

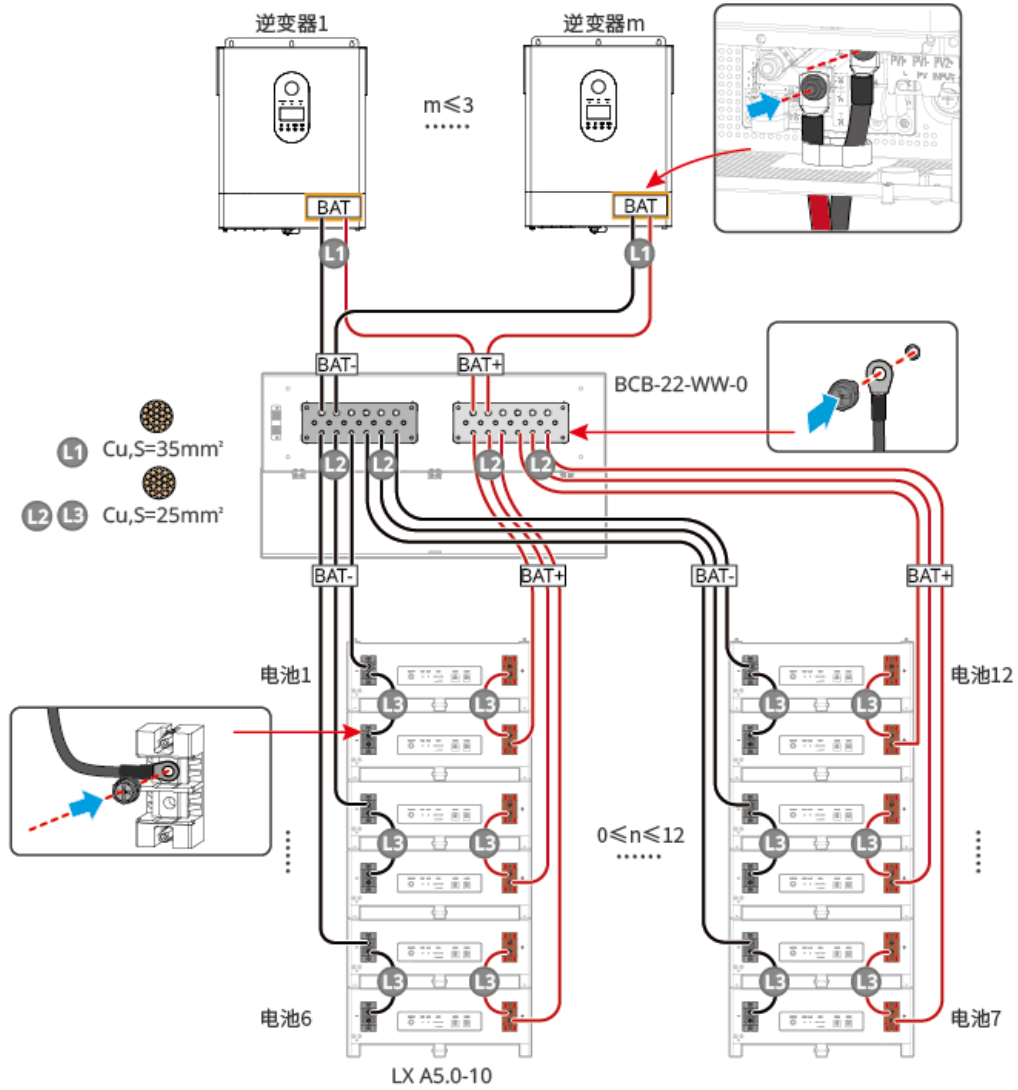

Make inverter cable

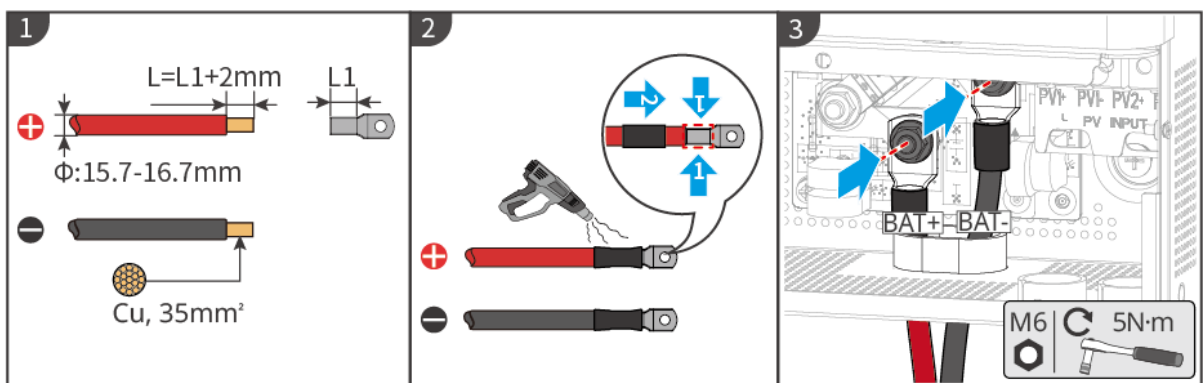

EO10ELC003

Make battery cable (LX A5.0-10)

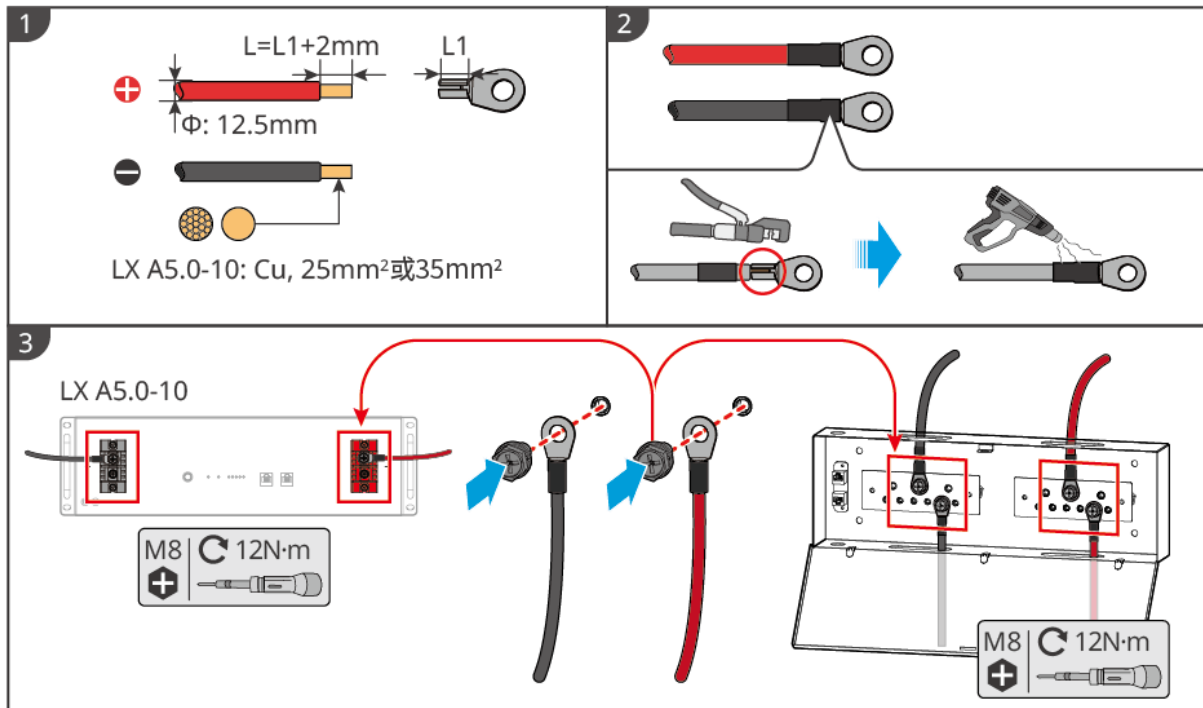

LXA10ELC0009

6.6.2 Connect the Communication Cable between Inverter and Battery

NOTICE

The BMS cable is included in the package of the inverter, the included BMS communication cable is recommended. If more communication cables are needed, prepare shielded network cables and RJ connectors by yourself to make the cable. Only crimp PIN4 and PIN5 of the connector when making the cable, otherwise the communication may fail.

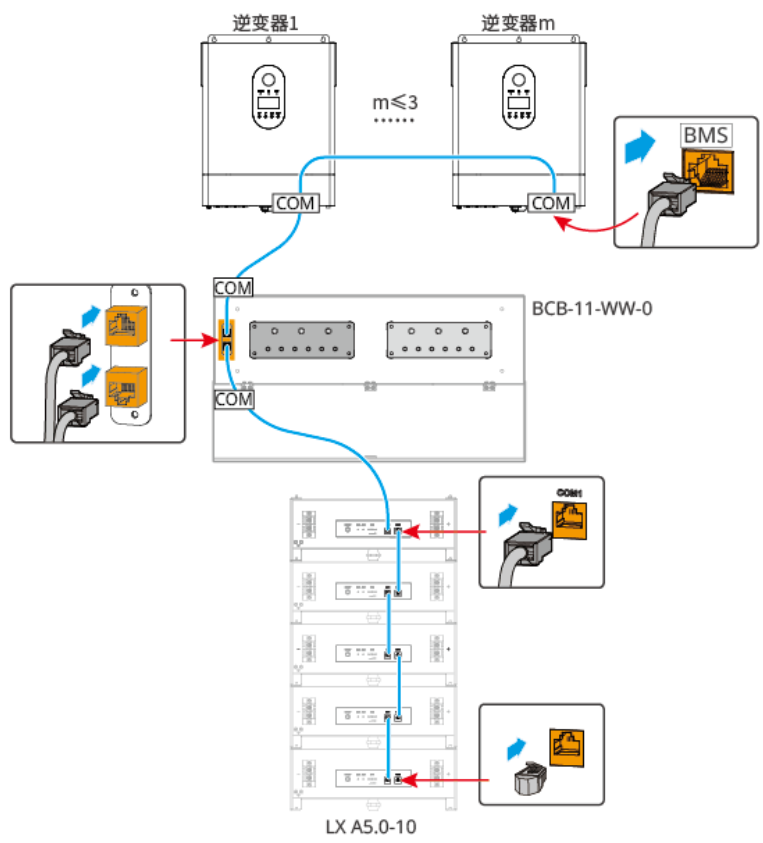
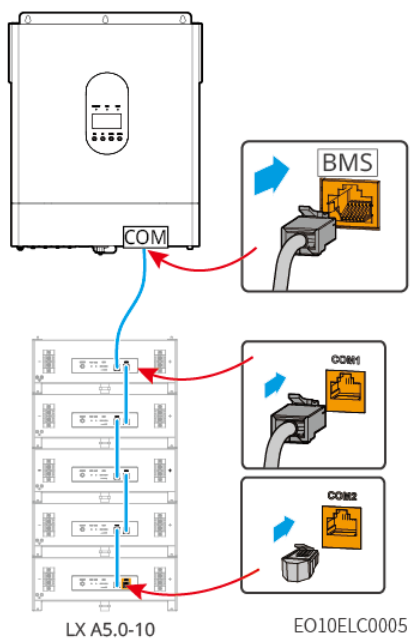

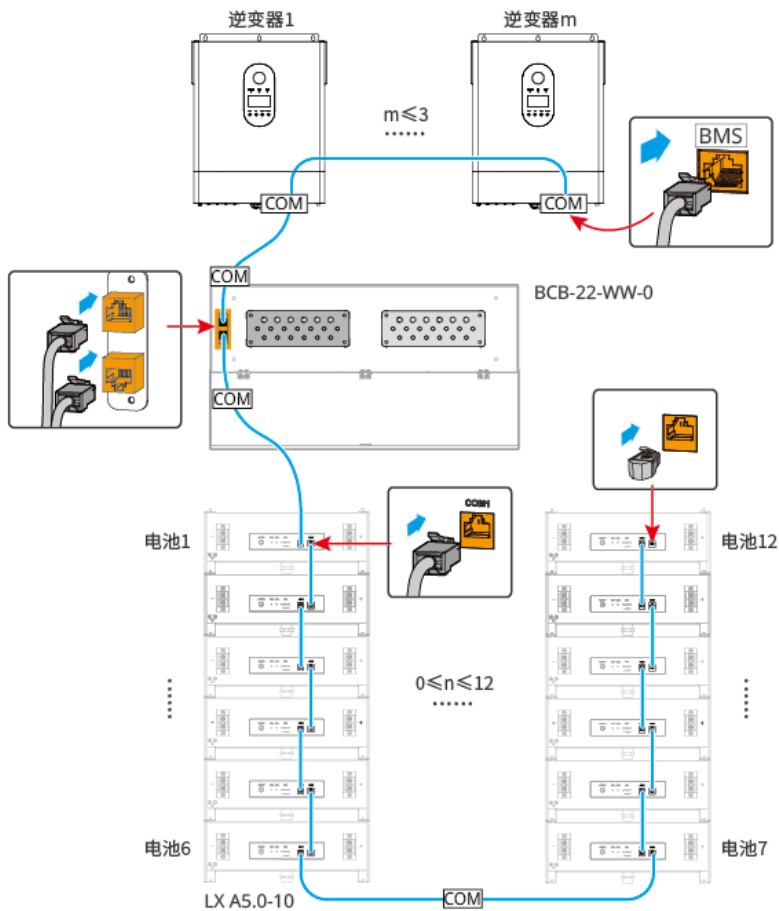

6.7 Connecting the AC Cable

WARNING

- The residual current monitoring unit (RCMU) is integrated into the off-grid inverter to avoid the residual current exceeds the limit. The inverter will disconnect the utility grid quickly once it found the residual current exceeds the limit.
- When wiring, ensure that the AC cable is completely matched with the "AC OUTPUT", "GEN", "AC INPUT" and grounding ports of the AC terminal. Incorrect cable connection will lead to equipment damage.
- Ensure that the whole cable cores are inserted into the terminal holes. No part of the cable core can be exposed.
- Ensure that the insulation board is inserted into the AC terminal tightly.
- Ensure that the cables are connected securely. Otherwise it will cause damage to the inverter due to overheat during its operation.

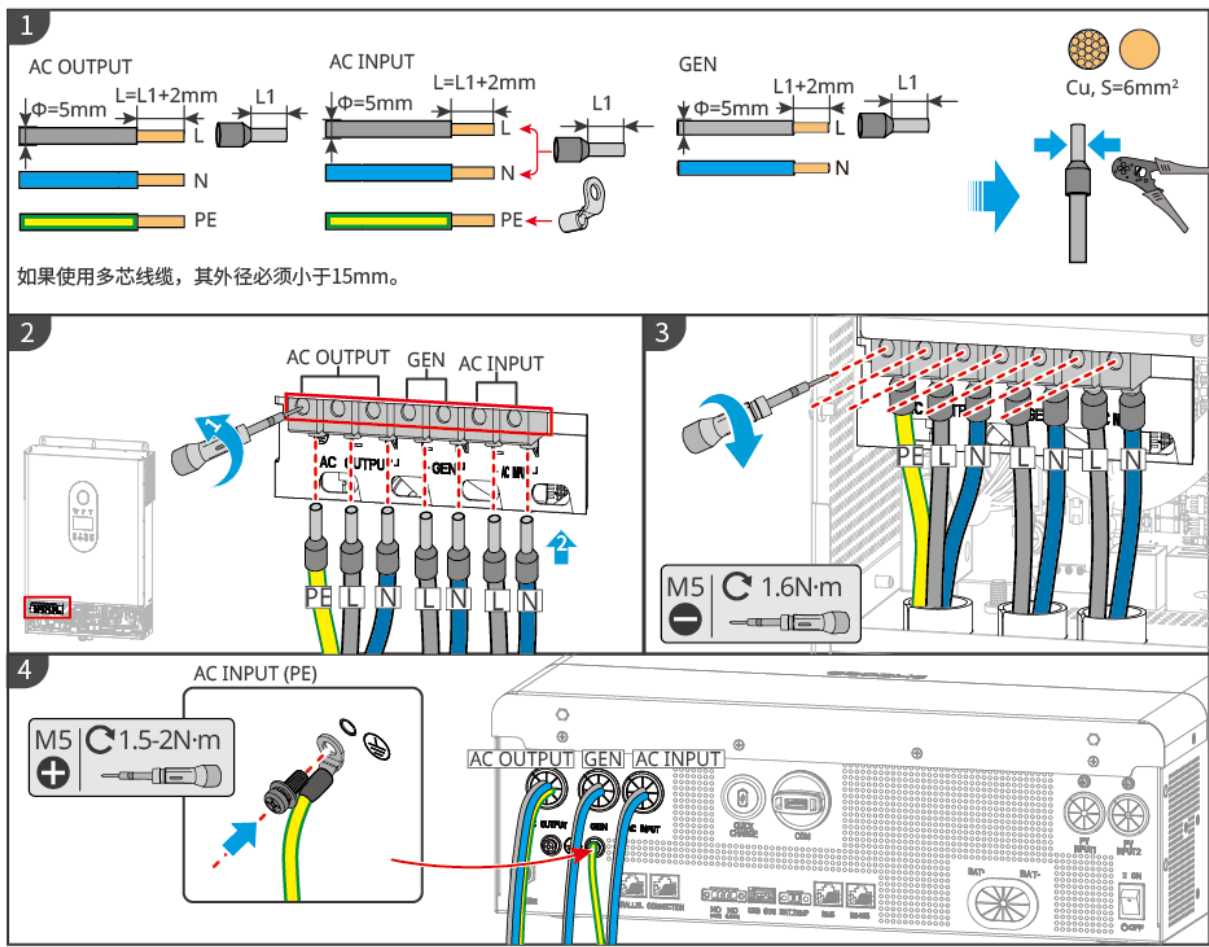

6.8 Connecting the Inverter Communication Cable

NOTICE

- The communication function of the off-grid inverter is optional, please choose according to the actual needs.
- In parallel system, the DIP switches of the first and the last inverter need to be turned to ON position.

Communication Descriptions

Cable: Shielded twisted pair cable that meets local standards.

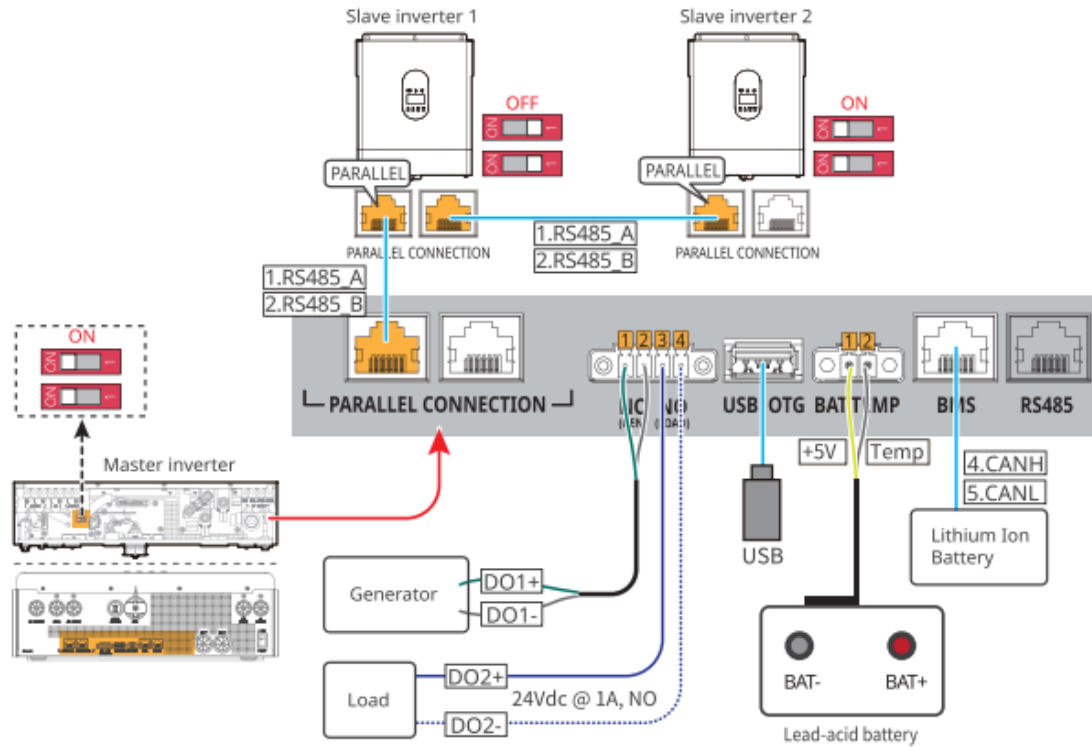

No.	Port	Description
1	Parallel Connection (PARALLEL CONNECTION)	Used for connecting cable for parallel communication.
2	Generator communication cable (NO, GEN)	Used for controlling the start and stop of the generator.
3	Load control port (NO, LOAD)	Used for controlling the load switch.
4	USB port (USB OTG)	Used to connect USB flash drive to export log or upgrade the inverter locally.
5	Lead-acid temperature measurement port (BAT. TEMP)	For connecting lead-acid battery temperature measurement cable.
6	BMS communication port (BMS)	Used for connecting lithium-ion battery communication cable.
7	RS485 communication port	Function reserved.

(RS485)

Connecting the communication cable

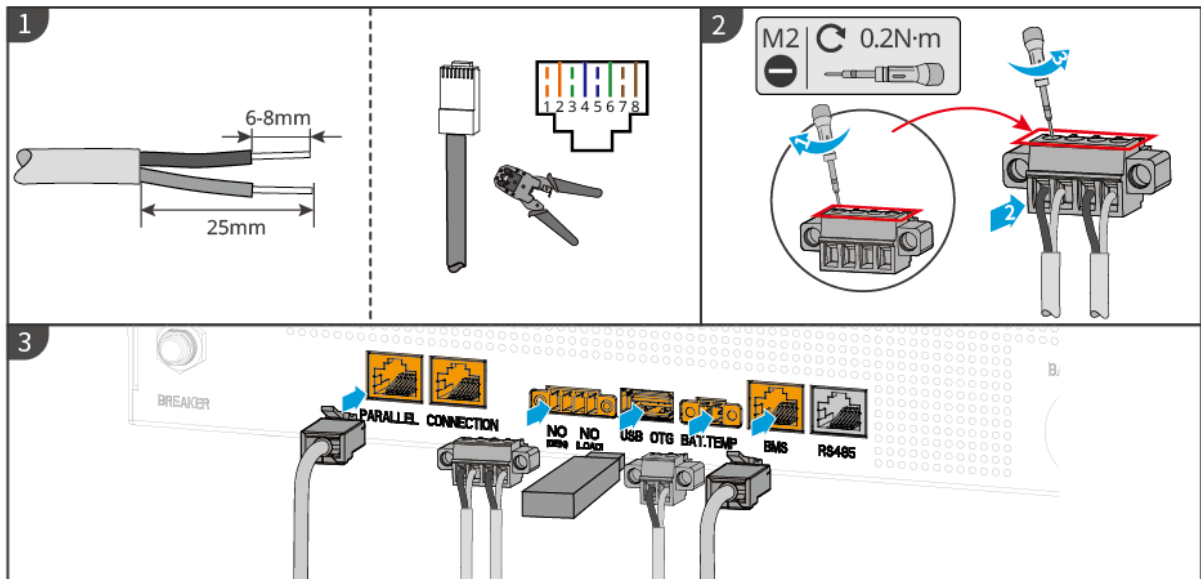

EO10ELC0004

6.9 Connecting the Smart Dongle

NOTICE

- The inverter supports connecting to mobile phones or WEB interfaces via WiFi/LAN Kit-20 to set device-related parameters, view equipment operation information and error messages, and promptly know the system status.
- In a parallel system with multi inverters, each inverter needs to be installed with a WiFi/LAN Kit-20 smart dongle.

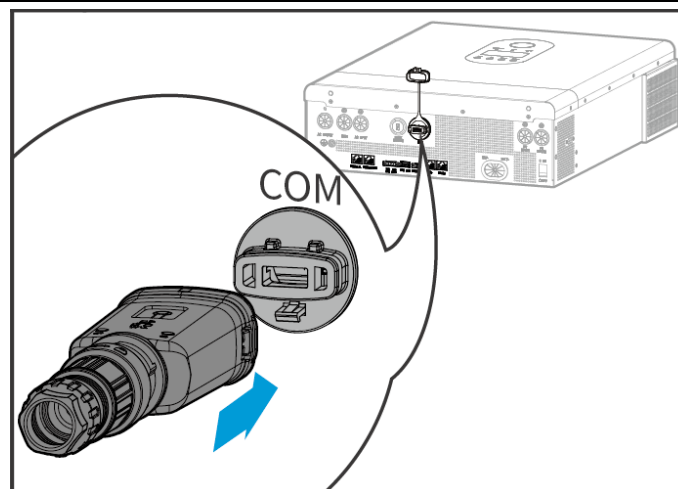

7 System Commissioning

7.1 Check before Power ON

No.	Check Item
1	The inverter is firmly installed in a clean place where is well-ventilated and easy to operate.
2	The PE, DC input, AC output, communication cables, and terminal resistors are connected correctly and securely.
3	Cable ties are intact, routed properly and evenly.
4	Unused wire holes and ports should be sealed up.
5	The used cable holes are sealed.
6	The voltage and frequency at the connection point meet the inverter grid connection requirements.

7.2 Power ON

WARNING

- When there are multiple inverters in the system, please ensure that the AC side of all slave inverters are powered on within one minute after the master inverter AC side is powered on.
- Battery black start scenarios:
 - The inverter needs to be activated by battery.
 - If there is no inverter, it is necessary to manage the charging and discharging of battery, etc.
- After the battery system is started, please ensure that the inverter communicates normally with the battery system within 15 minutes. If the inverter cannot communicate properly with the battery system, the battery system switch will automatically disconnect and the battery system will be powered off.
- When there are multiple LX A5.0-10 batteries in the system, starting any one of

them can start all the batteries.

7.2.1 Power on a Single Inverter System

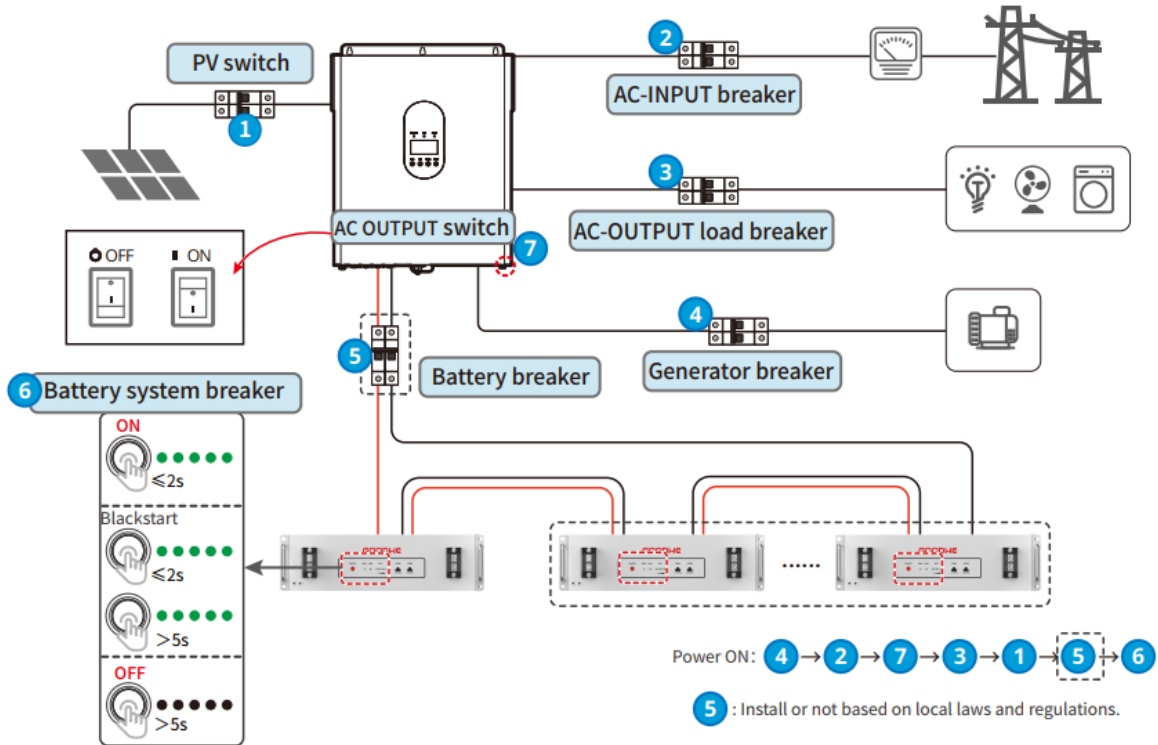

7.2.2 Power on a Multi-inverter System



WARNING

When the parallel system is powered on, please ensure that all off-grid inverters on the AC side are powered on within one minute after the main back-up inverter is powered on.

Single-phase parallel system

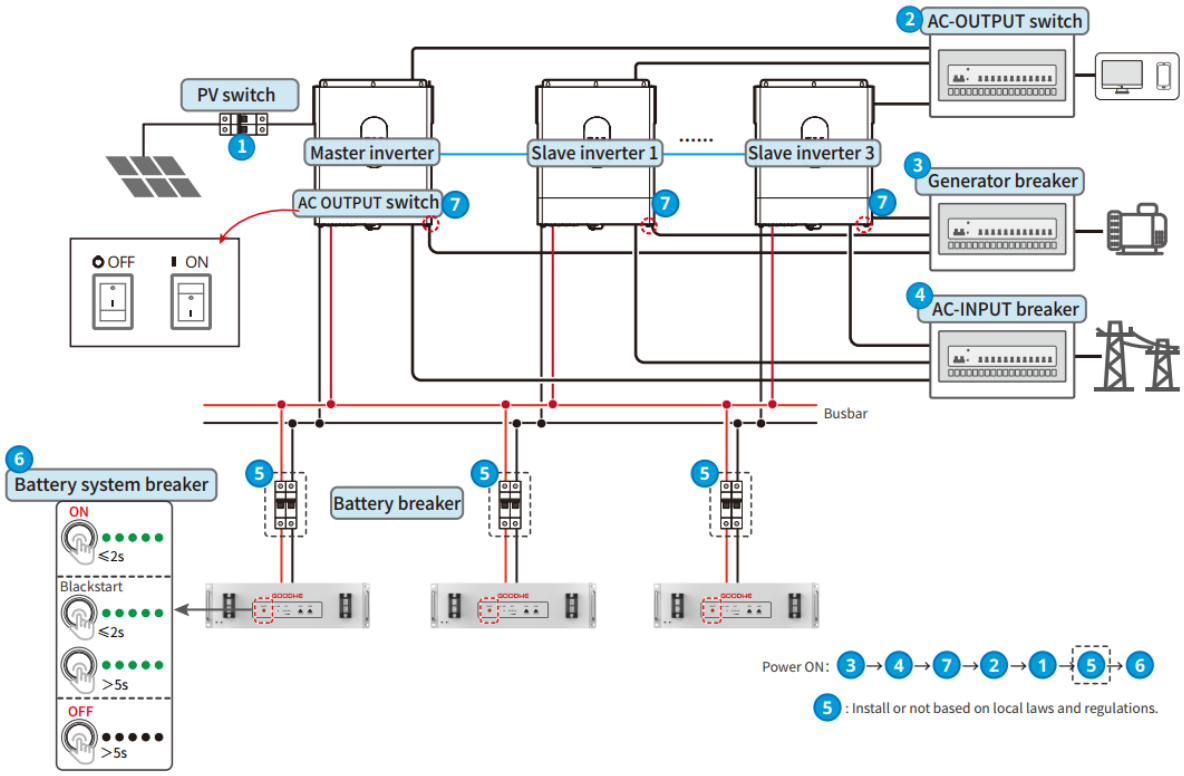



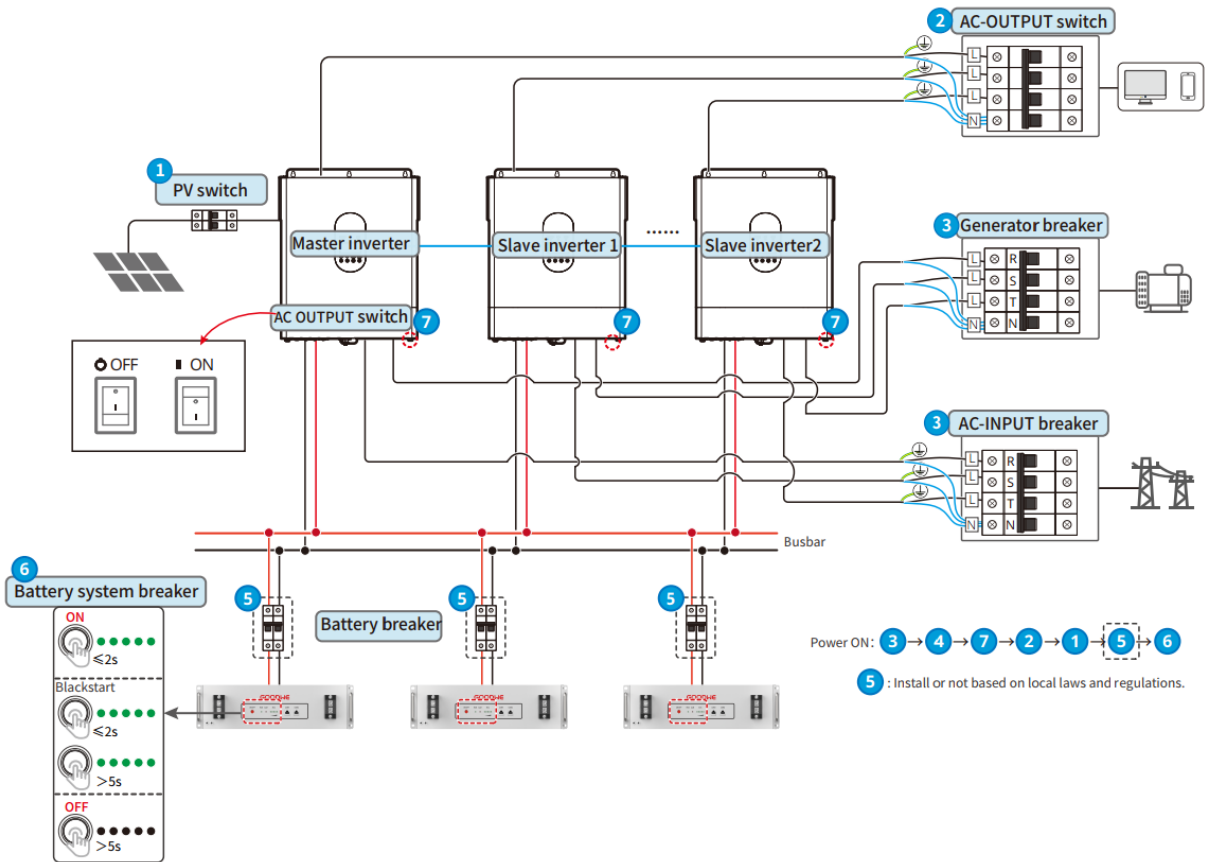







Single-phase to three-phase system



7.3 Indicators



7.3.1 Off-grid Inverter Indicator

Indicator	State	Description
AC/INV 		The AC input port provides power.
		The powered is supplied by PV or battery.
CHG 		The battery is fully charged.
		The battery is charging
		The battery is discharging or the battery is in non-charging and non-discharging state.
FAULT 		A fault has occurred.
		The inverter is warning.
		No fault in the inverter.

7.3.2 Battery Indicators

LX A5.0-10

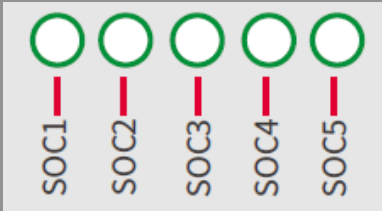
Normal Status

SOC indicator	RUN Indicator	Battery System Status
		
SOC indicator indicates the battery percentage of the battery system.	Green light blinks 1 time/s	The battery system is in standby state.
	Green light blinks 2 time/s	The battery system is in idle state.

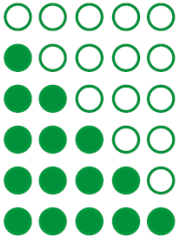









 <p>SOC < 5% 5% ≤ SOC < 25% 25% ≤ SOC < 50% 50% ≤ SOC < 75% 75% ≤ SOC < 95% 95% ≤ SOC ≤ 100%</p>	Green light steady on	The battery system is charging.
<p>The last SOC indicator blinks 1 time/s.</p> <ul style="list-style-type: none"> When 5% ≤ SOC < 25%, SOC 1 blinks. When 25% ≤ SOC < 50%, SOC 2 blinks. When 50% ≤ SOC < 75%, SOC 3 blinks. When 75% ≤ SOC < 95%, SOC 4 blinks. When 95% ≤ SOC ≤ 100%, SOC 5 blinks. 	Green light steady on	The battery system is in discharging status.

Abnormal Status

ALM Indicator 	Battery System Status	Description
Red light blink 1 time/s	Battery system alarm	Once an alarm occurs, the battery system will perform a self-check. After the battery system self-check is complete, the battery system enters operation or fault state.
Red light steady on	Battery system fault	Check both the button indicator and the SOC indicator status to determine the fault that has occurred and handle the problem follow the methods recommended in the Troubleshooting section.

7.3.4 Smart Dongle Indicator

WiFi/LAN Kit-20

Indicator	State	Description
Power indicator 		Steady on: The smart dongle has been powered on.
		Off: The smart dongle is not powered on.
Communication indicator 		Steady on: Communication in WiFi mode or LAN mode is normal.
		Blink 1 time: The Bluetooth signal of the smart dongle has been turned on, waiting for connection to SolarGo App.
		Blink 2 times: The smart dongle is not connected to router.
		Blink 4 times: The smart dongle is communicating with the router normally, but is not connected to the server.
		Blink 6 times: The smart dongle is identifying the connected device.
		Off: The software of the smart dongle is resetting or not powered on.

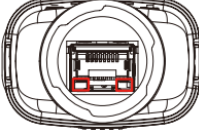
Indicator	Color	State	Description
Communication indicator in LAN Port 	Green	Steady on	The connection of the wired network at 100Mbps is normal.
		Off	<ul style="list-style-type: none"> ● The Ethernet cable is not connected. ● The connection of the wired network at 100Mbps is abnormal. ● The connection of the wired network at 100Mbps is normal.
	Yellow	Steady on	The connection of the wired network at 10/100 Mbps is normal, but no communication data is received or transmitted.
		Blinks	The communication data is being

			transmitted or received.
		Off	The Ethernet cable is not connected.

Button	Description
Reload	Press and hold for 0.5~3 seconds to restart the smart dongle.
	Press and hold for 6~20 seconds to restore the smart dongle to factory settings.
	Quickly double-click to turn on the Bluetooth signal (only maintain for 5 minutes).

8 Quick System Commissioning

8.1 Downloading the App

Make sure that the mobile phone meets the following requirements:

- Mobile phone operating system: Android 4.3 or later, iOS 9.0 or later.
- The mobile phone can access the Internet.
- The mobile phone supports WLAN or Bluetooth.

Method 1: Search SolarGo in Google Play (Android) or App Store (iOS) to download and install the app.

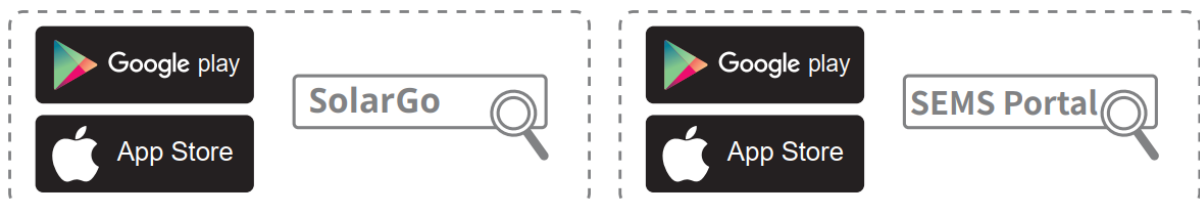

Method 2: Scan the QR code below to download and install the app.

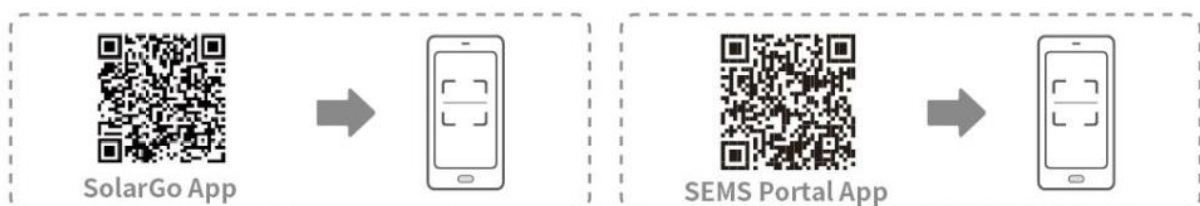

8.2 Connect the Inverter through SolarGo

NOTICE

The device name varies depending on the inverter model or smart dongle type:

- Bluetooth module: Solar-BLE***
- WiFi/LAN Kit-20: WLA-***

Connect the inverter via Bluetooth

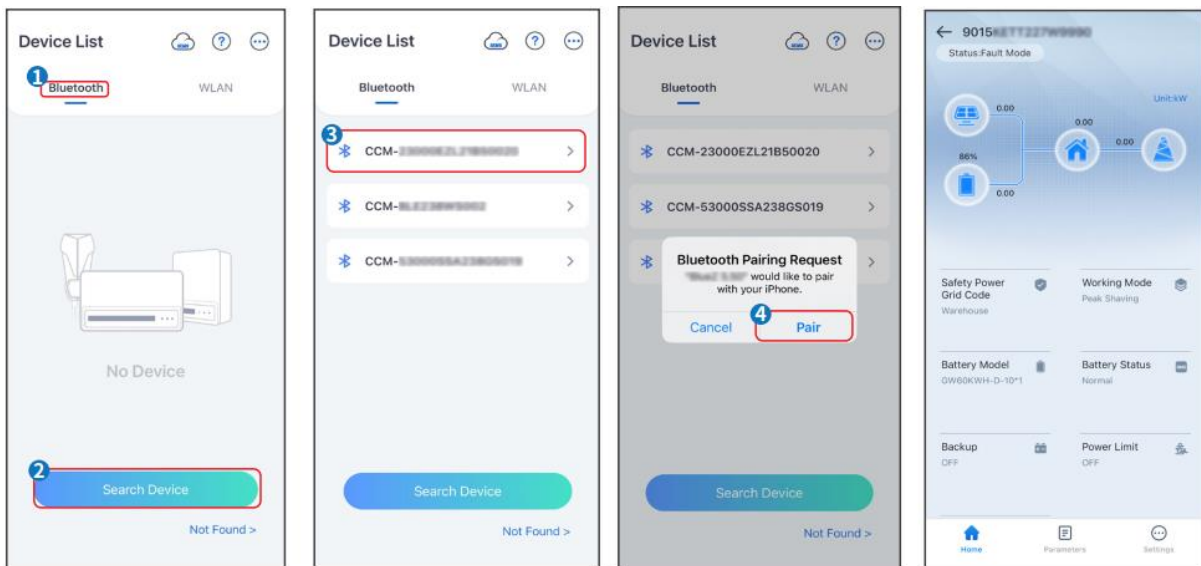

Connect to the inverter via WiFi

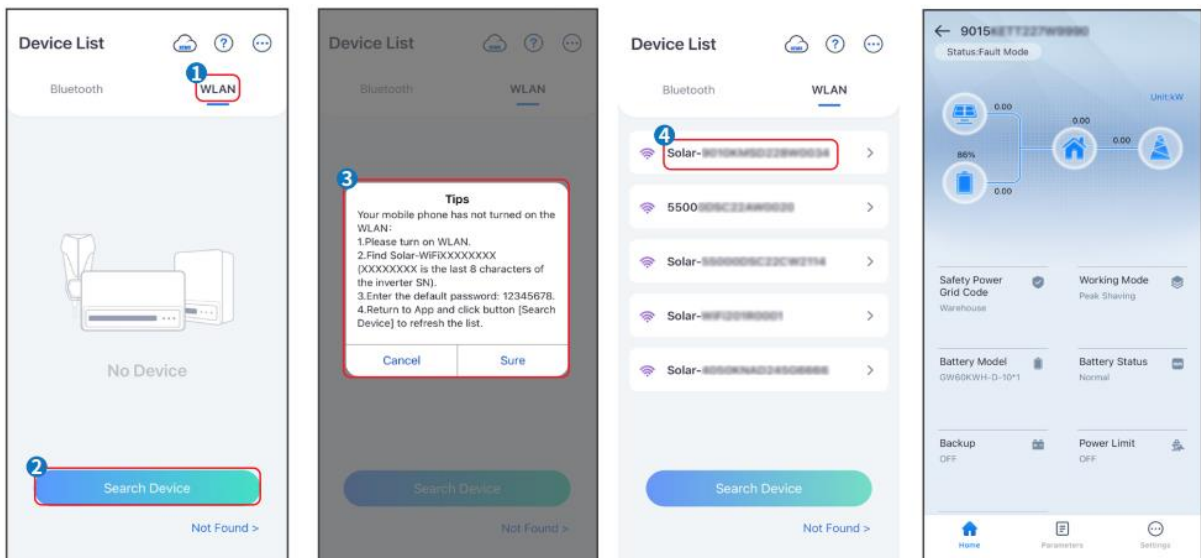

8.3 Communication Settings

Step 1: Enter the settings page through **Home > Settings > Communication Configuration > Network Settings**.

Step 2: Configure WLAN or LAN network according to the actual situation.

No.	Name/Icon	Description
1	Network Name	Applicable for WLAN. Please choose the corresponding network based on actual situation, and communicate with devices through routers or switches.
2	Password	Applicable for WLAN. Enter the password for the network you have selected.
3	DHCP	<ul style="list-style-type: none">● Enable DHCP when the router is in dynamic IP mode.● Disable DHCP when a switch is used or the router is in static IP mode.
4	IP Address	<ul style="list-style-type: none">● Do not configure the parameters when DHCP is enabled.● Configure the parameters according to the router or switch information when DHCP is disabled.
5	Subnet Mask	
6	Gateway Address	
7	DNS Server	

8.4 Quick Settings

NOTICE

- When selecting safety standards for countries/regions, the system will automatically configure over/under voltage protection, over/under frequency protection, off-grid inverter on-grid voltage/frequency, connection slope, Cosφ curve, Q (U) curve, P (U) curve, FP curve, high/low voltage ride-through, etc., according to the safety regulation requirements of different regions.
- The generation efficiency of inverter differs in different working modes. Please set according to the local actual electricity consumption.

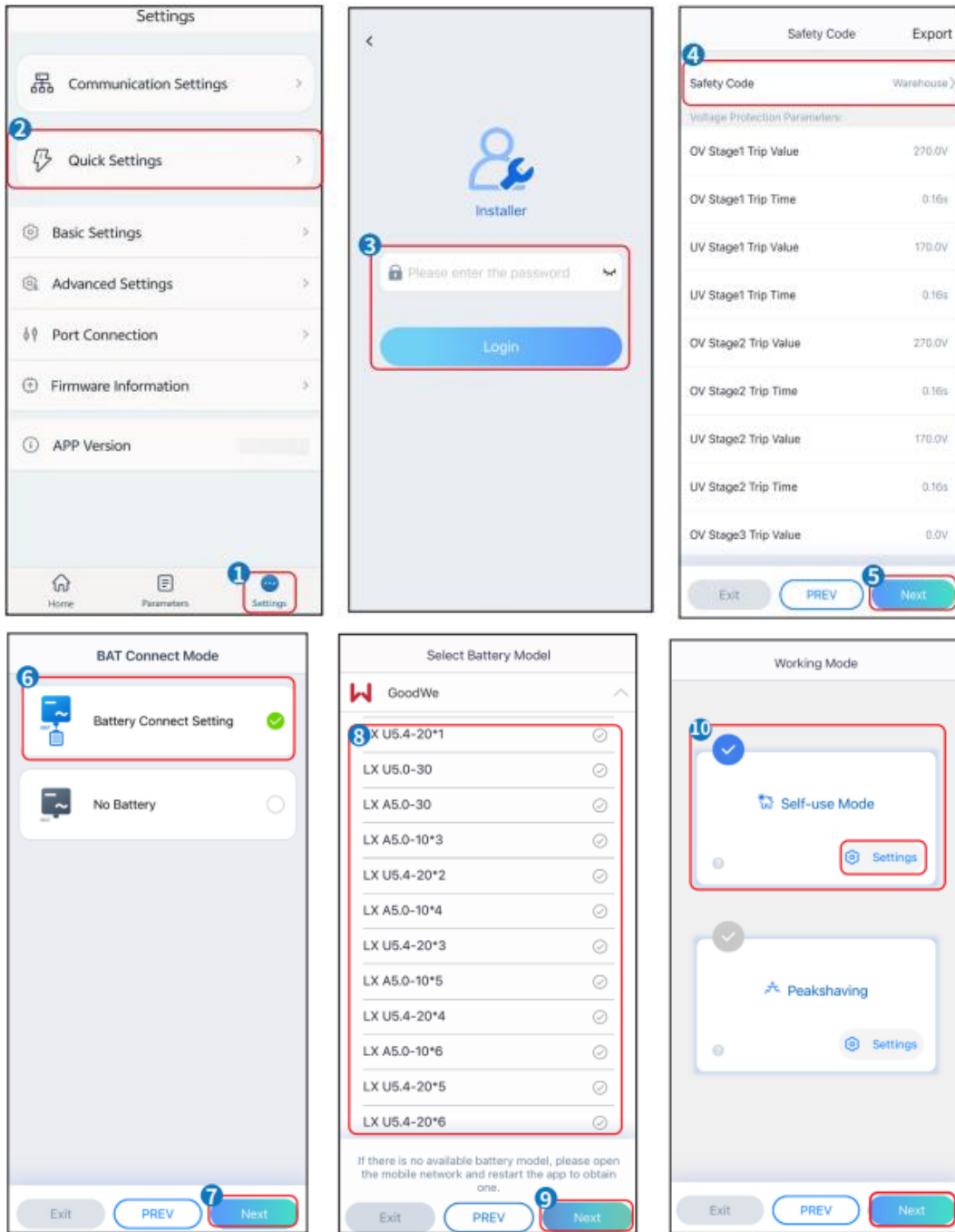

Parameter	Description
Safety Code	Choose the corresponding safety code according to the country or region where the equipment is located.
BAT Connect Mode	Select the actual mode of connecting the battery to the off-grid inverter. If there is no battery connected in the system, there is no need to configure the battery model and operation mode, and the device will operate in self-use mode by default.

Select Battery Model	Select the actual battery model.
Working Mode	Set the working mode of the equipment during operation. Supports: peakshaving mode and self-use mode.

The App interface is as following when Self-use mode is selected. Enter Advanced Settings to set the detailed working mode and related parameters.

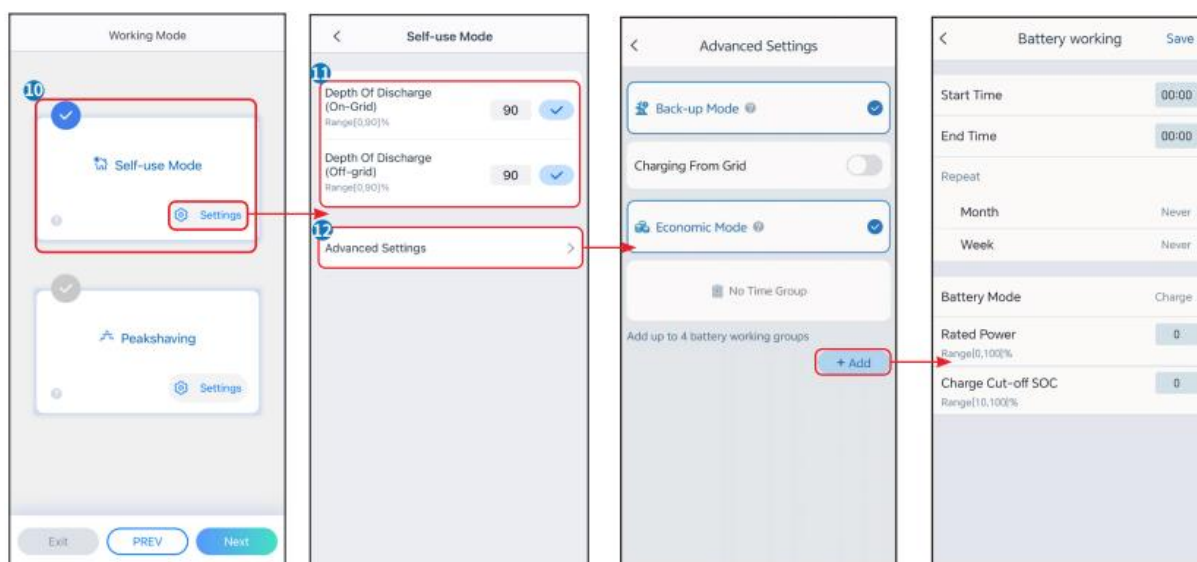

NOTICE

- When the off-grid inverter "**QUICK CHARGE**" switch is turned on or the **battery charging function** is activated through the SolarGo APP, the power grid will immediately charge the battery. This function take effect once every time. When the function is activated, the battery charging has the highest priority.
- Priority of working mode: quick charge > self-use mode > back-up mode > economic mode > peakshaving mode.
- The generation efficiency of inverter differs in different working modes. Please set according to the local actual electricity consumption.

Parameter	Description
Self-use mode:	Based on the self-use mode, back-up mode and economic mode can be enabled at the same time, and the inverter will automatically select the working mode.

Depth of discharge (on-grid)	The maximum depth of discharge of the battery when the system is working on-grid.
Depth of discharge (off-grid)	The maximum depth of discharge of the battery when the system is working off-grid.
Back-up mode	
Buy electricity from the grid for charging.	Enable this function to allow the system to buy electricity from the grid.
Nominal power	The percentage of power purchased compared to the nominal power of the inverter.
Economic mode	
Start time	Within the start and end time, the battery will charge or discharge based on the set charge/discharge mode and nominal power.
End Time	
Rated power	The percentage of power during charging compared to the nominal power of the inverter.
Charge/Discharge Cut-off SOC	Stop charging when the battery reaches the set SOC.

When choosing the peakshaving mode, the interface is as follows.

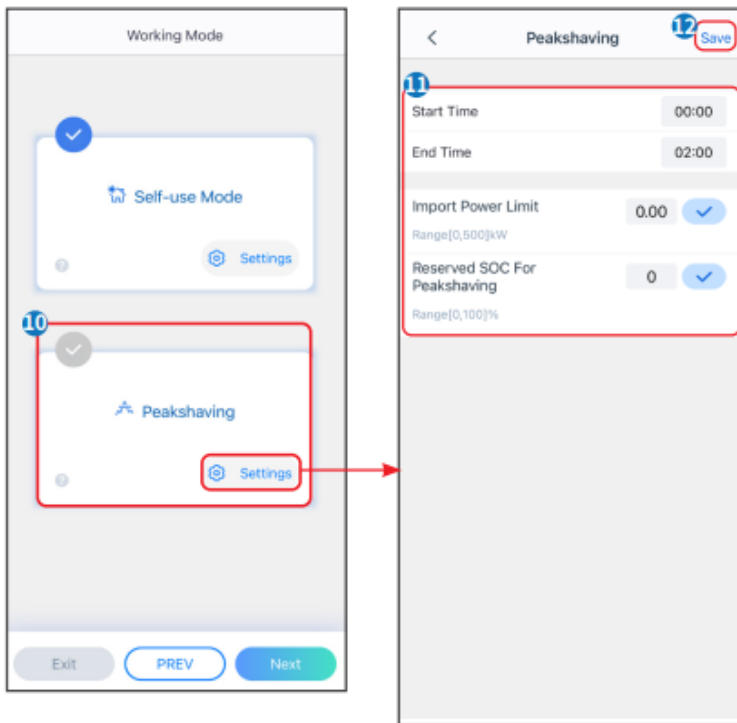

Parameter	Description
Peakshaving	
Start time	Within the start and end time, when the electricity consumption of the load does not exceed the electricity purchase quota, the battery can be charged from the grid. Beyond the time range, the battery can only be charged using the power generated by the photovoltaic system.
End time	
Import power limit	Set the maximum power limit for purchasing electricity from the grid. When the power usage of the load exceeds the amount of electricity generated in the photovoltaic system and import power limit, the battery will discharge to supplement power.
Reserved SOC for peakshaving	In peakshaving mode, the battery SOC is lower than the reserved SOC for peakshaving. When the battery SOC is higher than the reserved SOC for peakshaving, the function will fail.

8.5 Creating Power Plants

NOTICE

Login to the SEMS Portal app using the account and password before creating power plants. If you have any questions, refer to the **Plant Monitoring** section.

Step 1: Enter the interface for creating a power plant.

Step 2: Carefully read the prompts on the interface and fill in the power plant information based on actual conditions. (* refers to the mandatory items)

Step 3: Add devices according to the interface prompts to complete the creation of the power plant.

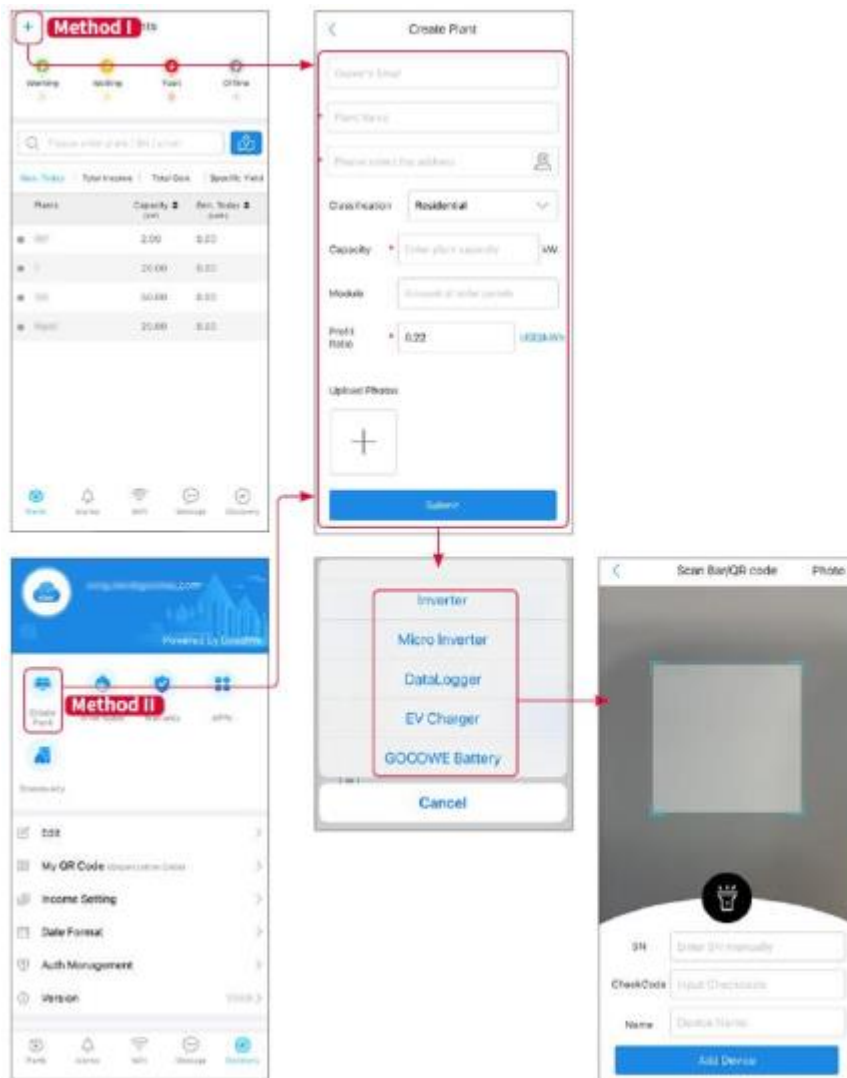



9 System Commissioning





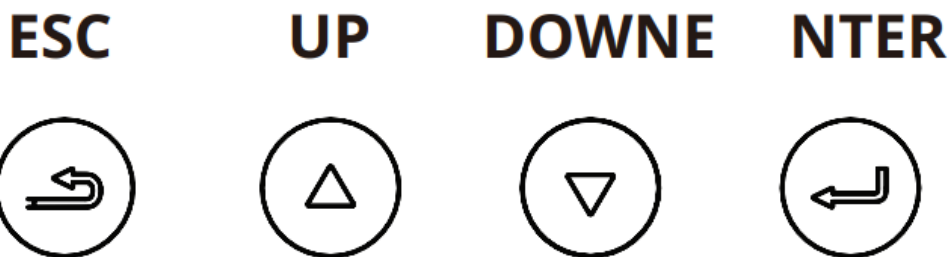
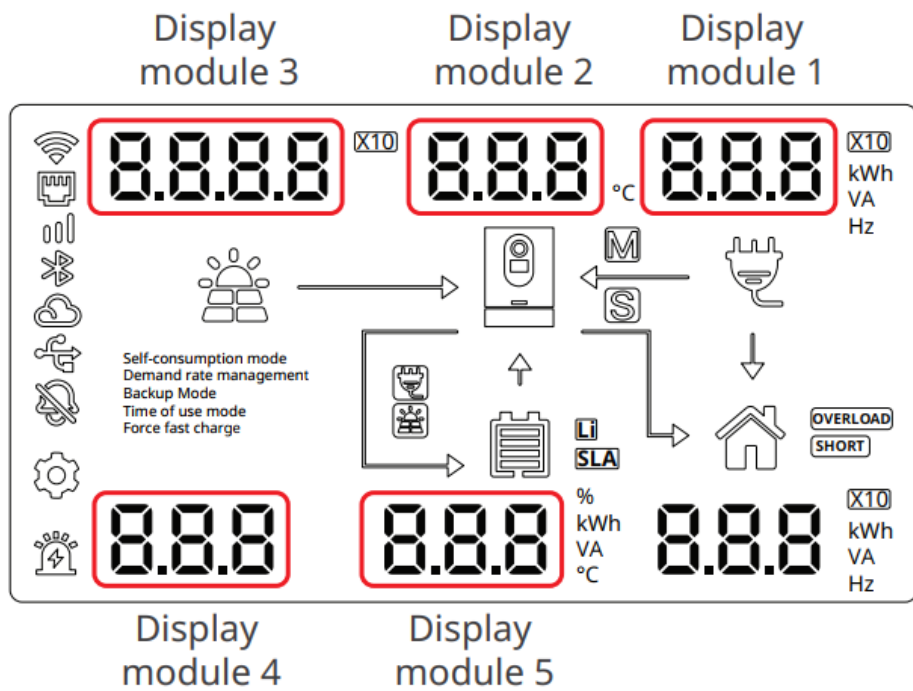





The off-grid inverter can be commissioned through the LCD screen or SolarGo APP.

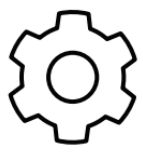

9.1 Set Parameters through LCD Screen

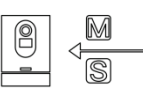
9.1.1 Introduction to LCD Screen



No.	Name/Icon	Description
1		Connected to the server via WiFi.

2		Connected to the server via LAN.
3		Connected to the server via LAN Bluetooth.
4		The server has been successfully connected.
5		The USB flash drive has been inserted.
6		Buzzer state.
7		Settings
8		Fault or alarm states.
9		Inverter status, M stands for master inverter, S stands for slave inverter.
10		The output is provided by the grid or diesel generator.
11		Load state.
12		Battery type and battery SOC. Li stands for lithium battery, SLA stands for lead-acid battery.

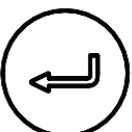
13		Function button, indicating to exit the current menu level.
14		Function button, upward.
15		Function button, downward.
16		Function button, confirm.
17	Display module 1	By adjusting the numbers of this module, different function settings can be made. Please refer to the Function Settings Table for details.
18	Display module 2	This module is the secondary menu of module 1, and its function depends on the display of module 1. Please refer to the specific Function Settings Table for details.
19	Display module 3	This module displays the current settings in progress. The number in this module represents the year only when the number displayed in module 1 is 005.
20	Display module 4	This module is for displaying the secondary menu of module 1, its functionality depends on module 1, please refer to the specific functions in the Function Display Table.
21	Display module 5	This module is for displaying the secondary menu of module 1, its functionality depends on module 1, please refer to the specific functions in the Function Display Table.

9.1.2 LCD Screen Settings

Adjust the numbers of different display modules and set parameters through the LCD

screen function buttons. Example:

Set working mode

Step 1: Long press the ENTER button to enter the parameter setting interface.

Step 2: On the parameter setting interface, when the number of module 1 is adjusted to 001, press ENTER button shortly to confirm and start setting the working mode.

Step 3: Module 2 blinks, press the DOWN button to adjust the working mode. Once the mode is selected, press the ENTER button to confirm.

Step 4: Press the ESC button to exit the settings and return to the main page.



Set safety code

Step 1: Long press the ENTER button to enter the parameter setting interface.

Step 2: In the parameter setting interface, when the number of module 1 is adjusted to 002, press the ENTER button briefly to confirm the start of setting the safety code.

Step 3: Display the unit digit of module 2 flashing, adjust the number of the safety code unit digit by pressing the DOWN button, press ENTER button to confirm after completion, and start setting the number of the tenth digit, press ENTER button to confirm after completion.

Step 4: Press the ESC button to exit the settings and return to the main page.

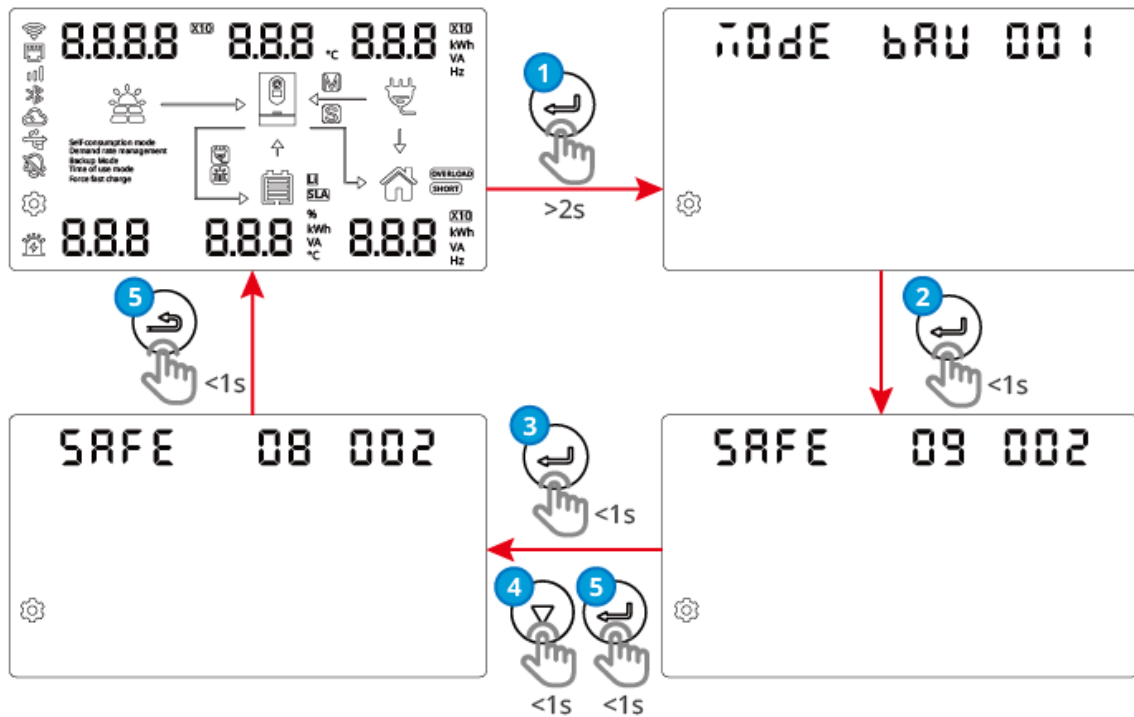

Function Settings Table

Display module 1	Display Module 2	Display Module 3.	Description
001	USE	MODE	Set the inverter working mode to self-use mode.
	BAU	MODE	Set the inverter working mode to back-up mode.
	ECO	MODE	Set the inverter working mode to economic mode.
	PRS	MODE	Set the inverter working mode to peakshaving mode.
002	01-89	SAFE	Set safety code, see safety code table for details.
003	OFF	ALAR	Disable the buzzer.
	ON	ALAR	Enable the buzzer.
005	-	2000	Set the year to 2000.
006	10	MON	Set the month to October.
007	16	DAY	Set the date to the 16th.

008	23	HOUR	Set the time to 23 o'clock.
009	59	MIN	Set the minutes to 59 minutes.
010	59	SEC	Set the seconds to 59 seconds.
011	DIS	EQ	Set to disable inverter output.
	ENR	EQ	Set to enable inverter output.
012	1	MAS	Set the inverter as master inverter.
	0	MAS	Set the inverter as slave inverter.
013	1	RSE	Set the phase of the inverter to phase R.
	2	RSE	Set the phase of the inverter to phase S.
	3	RSE	Set the phase of the inverter to T phase.
	0	RSE	Phase setting is invalid.

Function Display Table

Display module 1	Display module 4	Display module 5	Description
014	0	0	The master DSP version is version 00.
015	0	0	The slave DSP version is 00.
016	0	7	The ARM version is 07.

Safety Code Table

Code	Descriptions	Code	Descriptions
0	IT CEI 0-21	35	Ireland-25A
1	Czech	36	Taiwan
2	DE with PV	37	Bulgaria

3	ES mainland	38	Barbados
4	Greece	39	China Highest
5	Denmark	40	Britain G99
6	Belgium	41	SE LV
7	Romania	42	Chile BT
8	Britain G98	43	Brazil LV
9	Australia A	44	New Zealand
10	FR mainland	45	IEEE1547 208Vac
11	China	46	IEEE1547 220Vac
12	60Hz Default	47	IEEE1547 240Vac
13	PL LV	48	60Hz LV Default
14	South Africa	49	50Hz LV Default
16	Brazil	52	JP 50Hz
17	Thailand MEA	53	JP 60Hz
18	Mauritius	54	India Higher
19	Thailand PEA	55	DEWA LV
20	NL LV	56	DEWA MV
21	Northern Ireland	57	Slovakia
22	China Higher	58	NZ Green Grid
23	FR island 50Hz	59	Hungary
24	FR island 60Hz	60	Sri Lanka
27	NL 16/20A	61	ES island
28	Korea	64	IEEE1547-230/400
29	China Utility	65	IEC61727 60Hz

30	Austria	66	Switzerland
31	India	67	IT CEI 0-16
32	50Hz Default	68	Cyprus
33	Warehouse	85	Australia B
34	Philippines	86	Australia C

9.2 SolarGo Overview

SolarGo App is a mobile application that communicates with the inverter through Bluetooth or WiFi modules. Commonly used functions are as follows:

1. Check the operating data, software version, alarms, etc.
2. Set grid parameters, communication parameters, safety countries, power limitation, etc.
3. Equipment maintenance.
4. Upgrade the firmware version of the equipment.

9.2.1 App Interface Structure

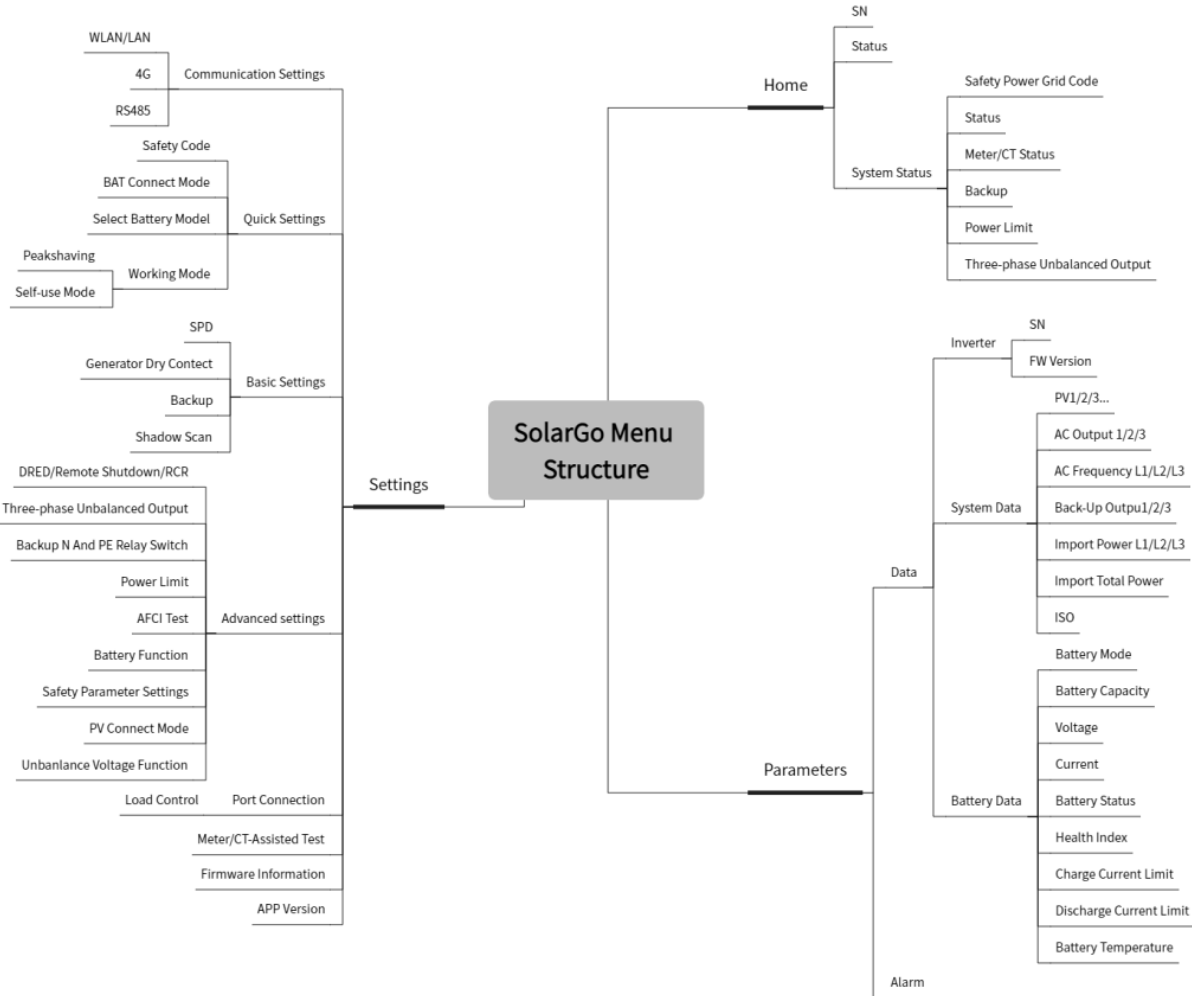

9.2.2 Introduction to the SolarGo App Login Interface

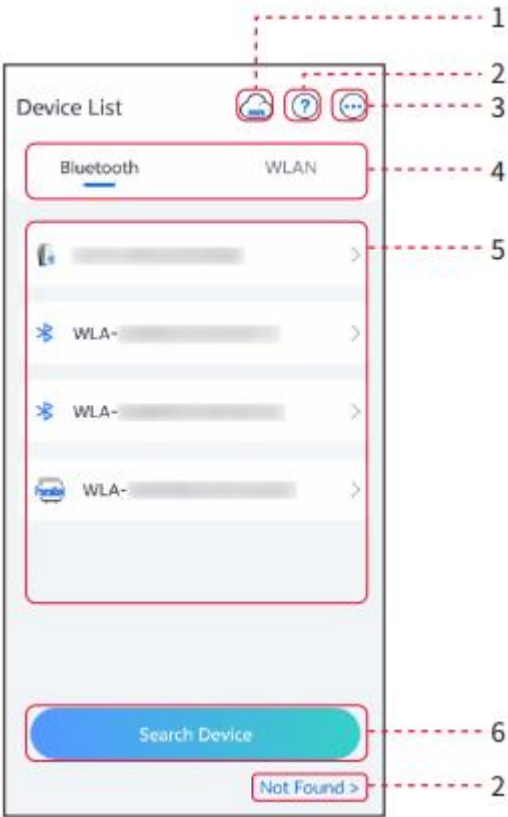



No.	Name/Icon	Description
1		Tap the icon to open the page downloading the SEMS Portal app.
2		Tap to read the connection guide.
	Not found	
3		<ul style="list-style-type: none"> ● Check information such as app version, local contacts, etc. ● Other settings, such as update data, switch language, set temperature unit, etc.
4	Bluetooth/WiFi	Select based on actual communication method. If you have any problems, tap or NOT Found to read the connection guides.
5	Device List	<ul style="list-style-type: none"> ● Display the list of connectable devices. The device names correspond to the device serial numbers, please select the corresponding device based on the device serial number.

		<ul style="list-style-type: none"> ● Select the device by checking the serial number of the master inverter when multi inverters are parallel connected. ● The device name varies depending on the inverter model or communication module.
6	Search Device	Tap Search Device if the device is not found.

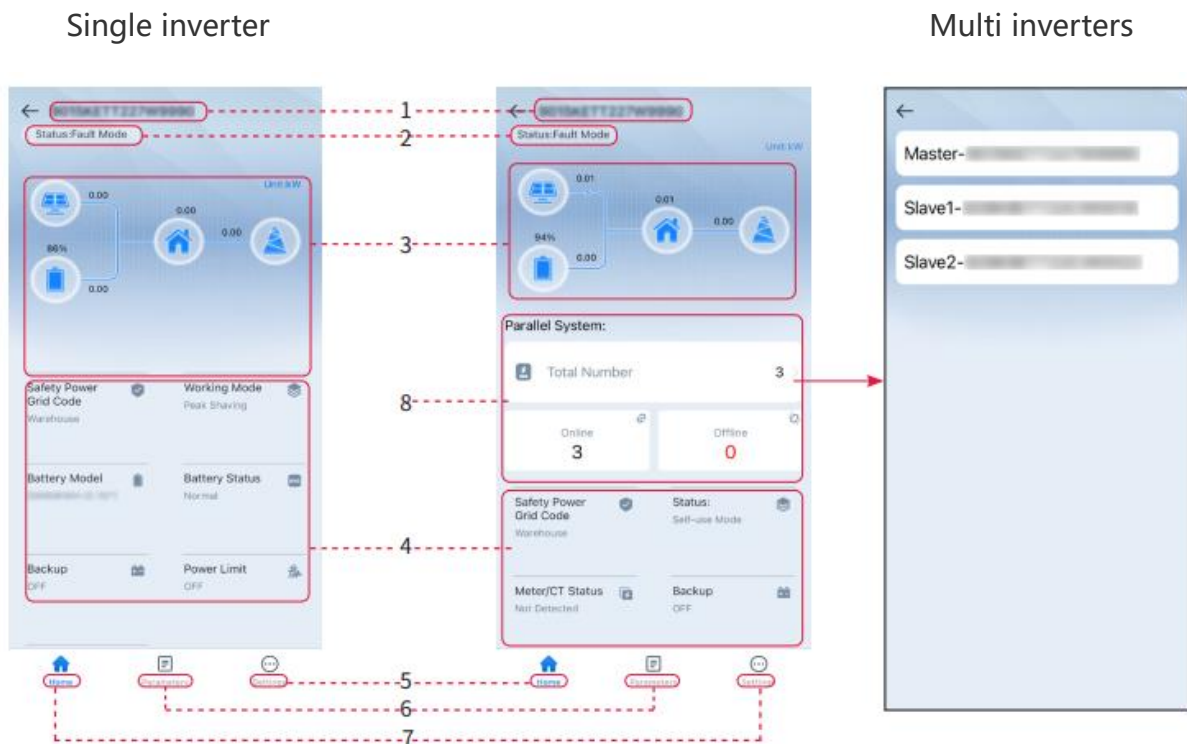
9.2.3 Introduction to the Main Interface of SolarGo App





No.	Name/Icon	Description
1	Serial Number	Display the connected device or serial number of the master inverter in the parallel system.
2	Device Status	Display the status of the inverter, such as operation, faults, etc.
3	Energy Flow Chart	Indicates the energy flow chart of the PV system. The actual page prevails.
4	System Status	Indicates the system status, such as safety code, working mode, battery model and battery status, etc.

5	 Home	Home. Tap Home to check Serial Number, Device Status, Energy Flow Chart, System Status, etc.
6		Parameters. Tap Parameters to check the running parameters of the system.
7		Settings. Log in before entering Quick Settings and Advanced Settings. Initial password: goodwe2010 or 1111.
8	Parallel	Tap Total Number to check serial number of all inverters. Tap the serial number to enter the setting page of the single inverter.

9.3 Connecting the Inverter via SolarGo

NOTICE

After the inverter is powered on, the displayed name of the communication module is: WLA-***** (* represents the device serial number)

- In single inverter system, when connecting the inverter via Bluetooth, the signal icon is .
- In the parallel system, when the inverter is connected via Bluetooth, the master signal icon is , and the slave signal icon is .

Connect the inverter via Bluetooth

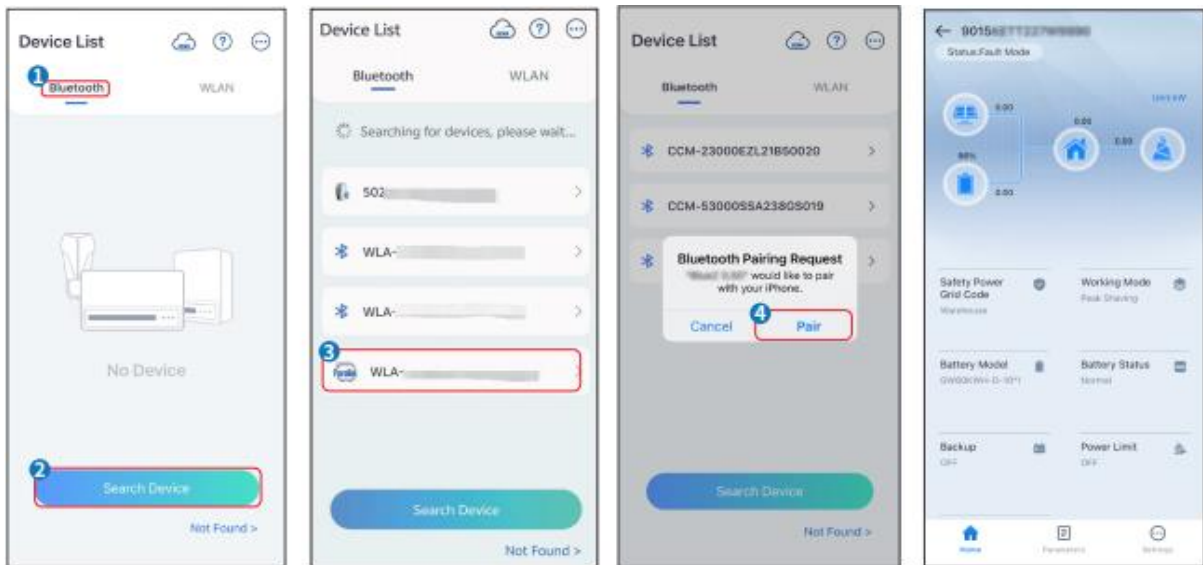

Connect to the inverter via WiFi

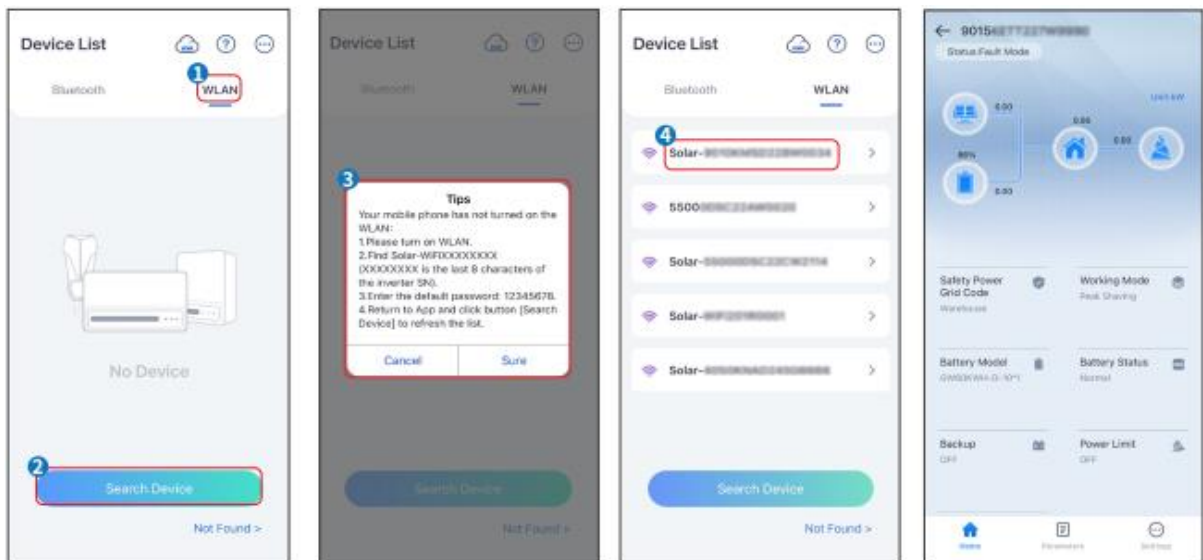

9.4 Communication Configuration

Setting WLAN/LAN

NOTICE

When the smart dongle connected to the inverter is different, the communication configuration interface may vary. Please refer to the actual interface for details.

Step 1: Go to **Home** > **Settings** > Communication Configuration to enter the settings page.

Step 2: Configure WLAN or LAN network according to the actual situation.

No.	Name/Icon	Description
1	Network Name	Suitable for WLAN. Please choose the corresponding network according to the actual situation, and communicate with the devices through router or switch.
	Password	Suitable for WLAN. Enter the password for the selected network.
	DHCP	<ul style="list-style-type: none"> ● Enable DHCP when the router is in dynamic IP mode. ● Disable DHCP when a switch is used or the router is in static IP mode.
	IP Address	<ul style="list-style-type: none"> ● Do not configure the parameters when DHCP is enabled. ● Configure the parameters according to the router or switch information when DHCP is disabled.
	Subnet Mask	
	Gateway Address	
	DNS Server	
2	4G	Select region and operator.
3	RS485	Communication address setting.

9.5 Quick Settings

NOTICE

- When selecting safety standards for countries/regions, the system will automatically configure over/under voltage protection, over/under frequency protection, off-grid inverter on-grid voltage/frequency, connection slope, $\text{Cos}\varphi$ curve, Q (U) curve, P (U) curve, FP curve, high/low voltage ride-through, etc., according to the safety regulation requirements of different regions.
- The generation efficiency of inverter differs in different working modes. Please set according to the local actual electricity consumption.

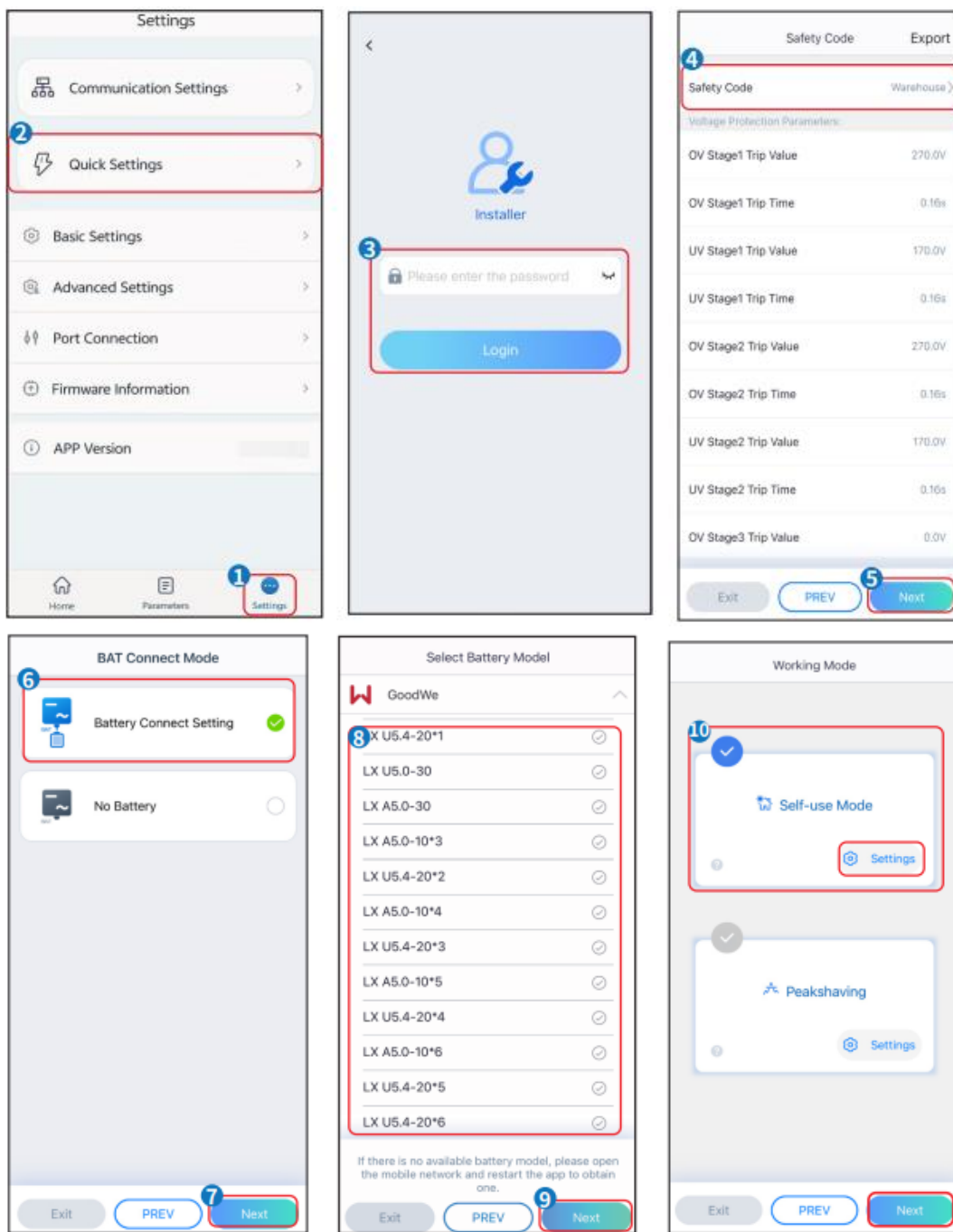

Parameter	Description
Safety Code	Choose the corresponding safety code according to the country or region where the equipment is located.
BAT Connect Mode	Select the actual mode of connecting the battery to the off-grid inverter. If there is no battery connected to the system, there is no need to configure the battery model and working mode. The device will default to operating in self-use mode.

Select Battery Model	Select the battery model according to the actual situation. After selecting the battery type and model, you need to set the parameters of the battery in the advanced settings - battery function settings section.
Working Mode	Set the working mode of the equipment during operation. Support self-use and peak shaving modes.

The App interface is as following when Self-use mode is selected. Enter Advanced Settings to set the detailed working mode and related parameters.

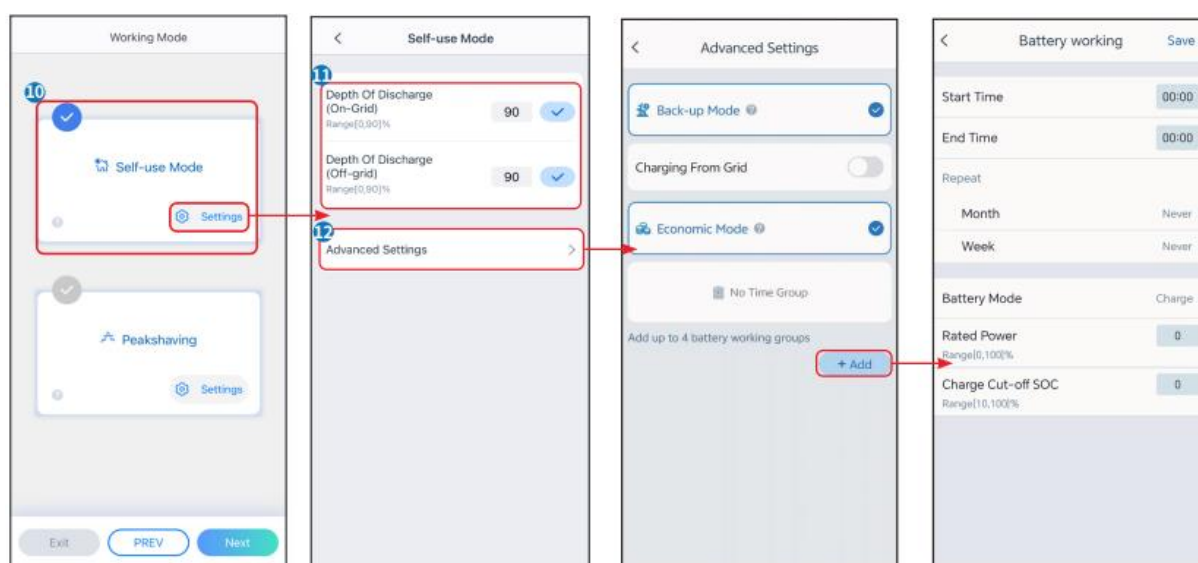

NOTICE

- When the off-grid inverter "**QUICK CHARGE**" switch is turned on or the **battery charging function** is activated through SolarGo, the power will charge the battery immediately. This function takes effect once every time. When the function is activated, the battery charging has the highest priority.
- Priority of working mode: quick charge > self-use mode > back-up mode > economic mode > peakshaving mode.
- The generation efficiency of inverter differs in different working modes. Please set according to the local actual electricity consumption.

Parameter	Description
Self-use mode: Based on the self-use mode, back-up mode and economic mode can be enabled at the same time, and the inverter will automatically select the working mode.	
Depth of discharge (on-grid)	The maximum depth of discharge of the battery when the system is working on-grid.
Depth of discharge (off-grid)	The maximum depth of discharge of the battery when the system is working off-grid.
Back-up mode	
Buy electricity from the grid for charging.	Enable this function to allow the system to buy electricity from the grid.
Nominal power	The percentage of power purchased compared to the nominal power of the inverter.
Economic mode	
Start time	Within the start and end time, the battery will charge or discharge based on the set charge/discharge mode and nominal power.
End Time	
Rated power	The percentage of power during charging compared to the nominal power of the inverter.
Charge/Discharge Cut-off SOC	Stop charging when the battery reaches the set SOC.

When choosing the peakshaving mode, the interface is as follows.

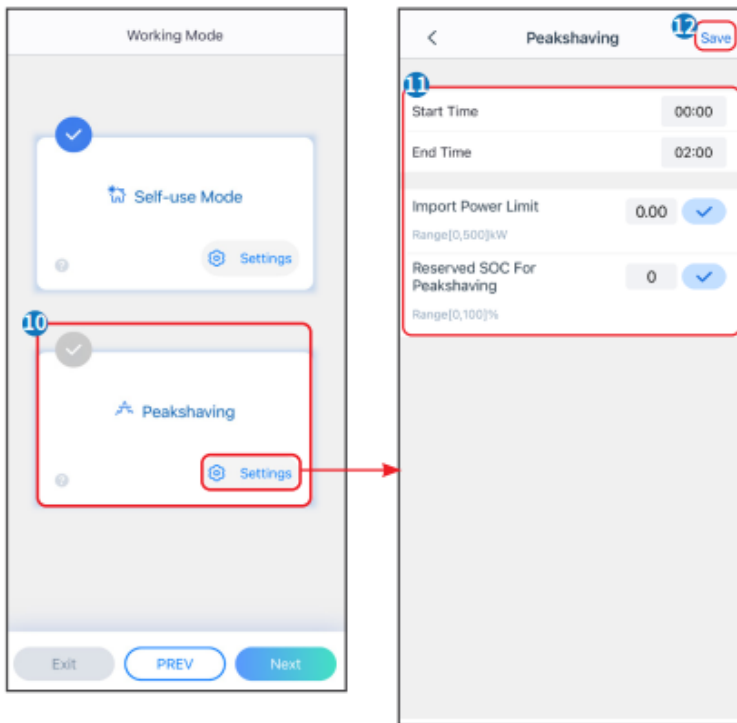

Parameter	Description
Peakshaving	
Start time	Within the start and end time, when the electricity consumption of the load does not exceed the electricity purchase quota, the battery can be charged from the grid. Beyond the time range, the battery can only be charged using the power generated by the photovoltaic system.
End time	
Import power limit	Set the maximum power limit for purchasing electricity from the grid. When the power usage of the load exceeds the amount of electricity generated in the photovoltaic system and import power limit, the battery will discharge to supplement power.
Reserved SOC for peakshaving	In peakshaving mode, the battery SOC is lower than the reserved SOC for peakshaving. When the battery SOC is higher than the reserved SOC for peakshaving, the function will fail.

9.6 Basic Settings

9.6.1 Setting Basic Parameters

Step 1: Go to **Home > Settings > Basic Settings** to enter the settings interface.

Step 2: Set up functions according to actual needs.

No.	Parameter	Description
1	Battery wake-up	After turning on, when the battery shuts down due to under-voltage protection, the battery can be activated.
2	Backup power	After the function is enabled, it can provide AC power output when off grid. Through this function, it is possible to set the off grid first cold start, off grid cold start maintenance, and clear overload faults.
3	Shadow scan	Enable Shadow Scan when the PV panels are severely shadowed to optimize the power generation efficiency.
4	Phase connection setting	<p>In single-phase to three-phase scenarios, this parameter needs to be set.</p> <ol style="list-style-type: none">1. Set the phase sequence of the off-grid inverter connected to the battery BMS to R phase as the master by default. The other two off-grid inverters are set to S phase and T phase respectively, by default as slaves.2. Unplug and re-plug the smart dongle of the master inverter, wait for about 1 minute, the LCD will display the master-slave symbol, and connect to the inverter Bluetooth signal () through the SolarGo APP to set related parameters.

Setting the Backup Function

After setting up the back-up power function, when the grid power is cut off, the load connected to the AC OUTPUT port of the off-grid inverter can be powered by the battery to ensure uninterrupted power supply to the load.

No.	Parameter	Description
1	UPS Mode - Full Wave Detection	Check whether the utility grid voltage is too high or too low.
2	UPS Mode - Half Wave Detection	Check whether the utility grid voltage is too low.
3	EPS Mode - Supports LVRT	Stop detecting utility grid voltage.
4	First Off-grid Cold Start	Only effective once. After enabling this function, you can use batteries or photovoltaic to output back-up power in back-up mode.
5	Cold Start Holding	Multiple activations. After enabling this function, you can use batteries or photovoltaic to output back-up power in back-up mode.
6	Clear Overload History	Once the power of loads connected to the inverter AC OUTPUT ports exceeds the nominal load power, the inverter will restart and detect the power again. The inverter will perform restart and detection several times until the overloading problem is solved. Tap Clear Overload History to reset the restart time interval after the power of the loads connected to the AC OUTPUT ports meets the requirements. The inverter will restart immediately.

9.7 Advanced Settings

9.7.1 Setting AFCI detection

Step 1: Go to **Home > Settings > Advanced Settings**, enter the parameter setting page.

Step 2: Set parameters according to actual needs. After entering the parameter values, click "√" or "Save" to save the parameter settings successfully.

No.	Parameter	Description	
1	Arc Test	AFCI Test	Enable or disable AFCI accordingly.
		AFCI Test Status	The test status, like Not Self-checking, self-check succeeded, etc.
		Clear AFCI Alarm	Clear ARC Faulty alarm records.
		Self-check	Tap to check whether the AFCI function works normally.

9.7.2 Setting Battery Function

Step 1: Go to **Home > Settings > Advanced Settings > Battery Function** to enter the parameter setting interface.

Step 2: Enter the parameter values as needed, then click "√" to successfully set the parameters.

No.	Parameter	Description
1	SOC Protection	Start battery protection when the battery capacity is lower than the Depth of Discharge .
2	Depth of discharge (on-grid)	Indicates the depth of discharge of the battery when the inverter is on-grid or off-grid.

3	Depth of discharge (off-grid)	
4	Backup SOC Holding	The battery will be charged to preset SOC protection value by utility grid or PV when the system is running on-grid. So that the battery SOC is sufficient to maintain normal working when the system is off-grid.
5	Immediate Charging	Enable to charge the battery by the grid immediately. Take effect once. Enable or Disable based on actual needs.
6	SOC for Stopping Charging	Stop charging the battery once the battery SOC reaches SOC for Stopping Charging.
7	Immediate Charging Power	Indicates the percentage of the charging power to the inverter rated power when enabling Immediate Charging. For example, setting the Immediate Charging Power of a 10kW inverter to 60 means the charging power of the inverter is $10\text{kW} \times 60\% = 6\text{kW}$.

9.7.3 Setting Safety Parameters

NOTICE

Set the custom safety parameters in compliance with local requirements. Do not change the parameters without the prior consent of the grid company.

Step 1: Go to **Home > Settings > Advanced Settings > Safety Parameter Settings** to enter the parameter setting page.

Step 2: Set parameters according to actual needs. After entering the parameter values, click "√" or "Save" to save the parameter settings successfully.

No.	Description	
1	Setting the active power	Set overload derating, underload over-frequency, output response

mode	mode, etc.
Setting the reactive power mode	Set the angle and Output Power Factor of the inverter.
Grid Protection Parameters	Set grid protection parameters and frequency protection parameters.
Grid connection parameters	Set the parameters for start-up on-grid and fault reconnection.
Voltage ride through parameters	Set parameters such as low voltage high voltage crossing, fault crossing mode, and current distribution mode.
Frequency fault ride through	Start-stop frequency fault ride through function and related parameter settings.

9.7.3.1 Setting Active Power Mode

Setting the P(F) Curve

Step 1: Go to **Home > Settings > Advanced Settings > Safety Parameter Settings > Active Mode Settings**, enter the parameter setting page.

Step 2: Enter the parameters according to actual needs.

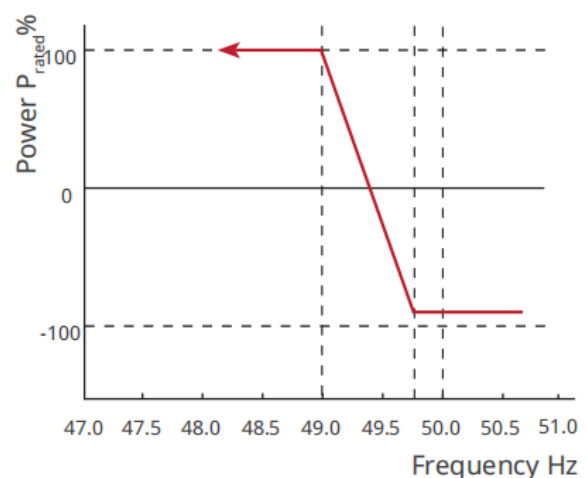
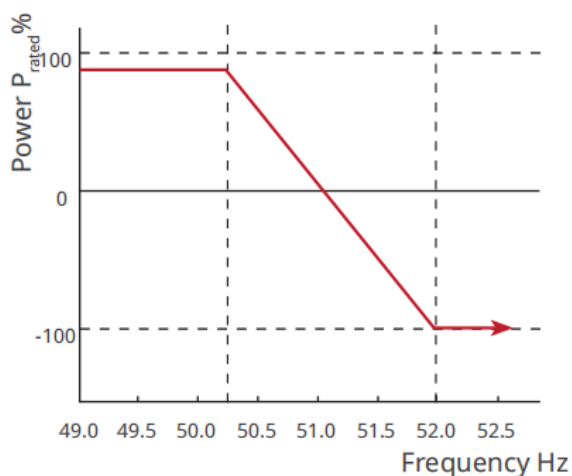

Setting the P(U) Curve

Step 1: Go to **Home > Settings > Advanced Settings > Safety Parameters Settings > Active Mode Settings**, enter the parameter setting page.

Step 2: According to the actual needs, input the parameters. After the parameter settings are successful, the off-grid inverter will adjust the ratio of active power and apparent power output in real time based on the actual value and rated value of the grid voltage.

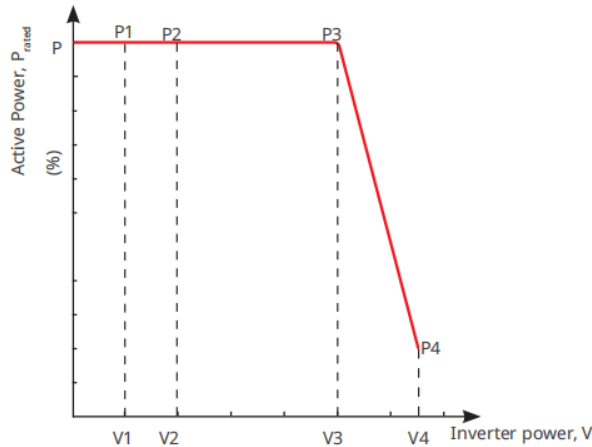

9.7.3.2 Setting Reactive Power Mode

Setting the Fix PF

Step 1: Go to **Home > Settings > Advanced Settings > Safety Regulation Parameter Settings > Reactive Power Mode Settings** to access the parameter settings page.

Step 2: According to actual needs, input the parameters. After the parameters are set successfully, the Output Power Factor remains constant during the operation of the back-up inverter.

No.	Parameter	Description
1	Fix PF	Enable Fix PF when it is required by local grid standards and requirements.
2	Under-excited	Set the power factor as lagging or leading based on actual needs and local grid standards and requirements.
3	Over excitation	

4	Power Factor	Set the power factor based on actual needs. Range: -1~-0.8, or +0.8~+1.
---	--------------	---

Setting the Fix Q

Step 1: Go to **Home > Settings > Advanced Settings > Safety Regulation Parameter Settings > Reactive Power Mode Settings** to access the parameter settings page.

Step 2: According to actual needs, input the parameters. After the parameters are set successfully, the back-up inverter will maintain constant reactive power output during operation.

No.	Parameter	Description
1	Fix Q	Enable Fix Q when it is required by local grid standards and requirements.
2	Under-excited	Set the reactive power as inductive or capacitive reactive power based on actual needs and local grid standards and requirements.
3	Over excitation	
4	Power Factor	The percentage of reactive output power to apparent power.

Setting the Q(U) Curve

Step 1: Go to **Home > Settings > Advanced Settings > Safety Regulation Parameter Settings > Reactive Power Mode Settings** to access the parameter settings page.

Step 2: Input parameters according to actual needs, and after successful parameter setting, the off grid inverter will adjust the actual value of the grid voltage to the rated value. Real time adjustment of the ratio of reactive power to apparent power output.

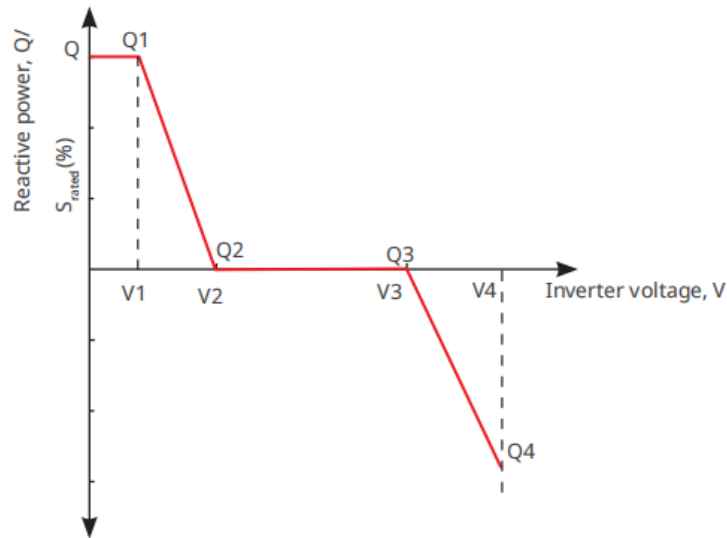

Setting the Cosφ Curve

Step 1: Go to Home > Settings > Advanced Settings > Safety Regulation Parameter Settings > Reactive Power Mode Settings to access the parameter settings page.

Step 2: Input parameters according to actual needs, and successfully set the inverter to back-up mode. The inverter adjusts the ratio of active power and apparent power output in real time based on the actual value and rated value of the grid voltage.

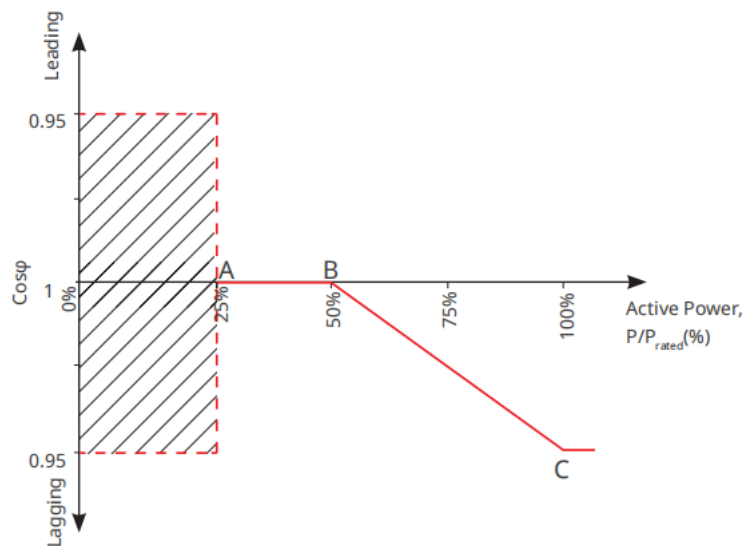

9.7.3.3 Setting Protection Parameters

Step 1: Go to Home > Settings > Advanced Settings > Safety Parameter Settings > Protection Parameters to enter the parameter settings page.

Step 2: Enter parameter values according to actual needs.

No.	Parameter	Description
Voltage Protection Parameters		
1	OV Stage n Trip Value	Set the grid overvoltage protection threshold value, n = 1, 2, 3.
2	OV Stage n Trip Time	Set the grid overvoltage protection tripping time, n = 1, 2, 3.
3	UV Stage n Trip Value	Set the grid undervoltage protection threshold value, n = 1, 2, 3.
4	UV Stage n Trip Time	Set the grid undervoltage protection tripping time, n = 1, 2, 3.
5	Grid 10min Overvoltage	Set the 10min overvoltage protection threshold value.
Frequency Protection Parameters		
6	OF Stage n Trip Value	Set the grid overfrequency protection threshold value, n = 1, 2.
7	OF Stage n Trip Time	Set the grid overfrequency protection tripping time, n = 1, 2.
8	UF Stage n Trip Value	Set the grid underfrequency protection threshold value, n = 1, 2.
9	UF Stage n Trip Time	Set the grid underfrequency protection tripping time, n = 1, 2.

9.7.3.4 Setting Connection Parameters

Step 1: Go to **Home > Settings > Advanced Settings > Safety Parameter Settings > Connection Parameters** to access the parameter setting page.

Step 2: Enter parameter values according to actual needs.

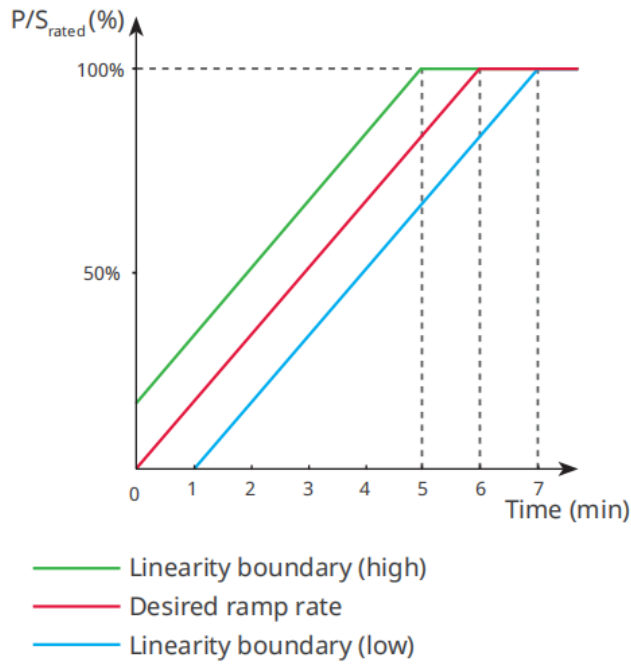

9.7.3.5 Setting Voltage Ride Through

Step 1: Go to **Home > Settings > Advanced Settings > Safety Parameter Settings > Voltage Ride Through** to enter the parameter setting page.

Step 2: Enter parameter values according to actual needs.

Serial number	Parameter	Description
LVRT		
1	Ride Through Voltage Start Point	The inverter will not be disconnected from the utility grid immediately when the grid voltage is between Ride Through Voltage Start Point and Ride Through Voltage End Point.
2	Ride Through Voltage End Point	
3	Ride Through Time Start Point	Indicates the longest duration the inverter can remain connected to the grid when the grid voltage is at the Ride Through Voltage Start Point.

4	Ride Through Time End Point	Indicates the longest duration the inverter can remain connected to the grid when the grid voltage is at the Ride Through Voltage End Point.
5	Ride Through Trip Threshold	LVRT is allowed when the grid voltage is lower than Ride Through Trip Threshold
HVRT		
6	Ride Through Voltage Start Point	The inverter will not be disconnected from the utility grid immediately when the grid voltage is between Ride Through Voltage Start Point and Ride Through Voltage End Point.
7	Ride Through Voltage End Point	
8	Ride Through Time Start Point	Indicates the longest duration the inverter can remain connected to the grid when the grid voltage is at the Ride Through Voltage Start Point.
9	Ride Through Time End Point	Indicates the longest duration the inverter can remain connected to the grid when the grid voltage is at the Ride Through Voltage End Point.
10	Ride Through Trip Threshold	HVRT is allowed when the grid voltage is higher than Ride Through Trip Threshold

9.8 Port Connection

9.8.1 Setting Generator Control

Step 1: Go to **Home > Settings > Port Connection > Generator Control**, enter the parameter setting interface.

Step 2: Enter the parameter values as needed and click "✓" to successfully set the parameters.

Manual control generator (does not support dry node connection): This type of generator only supports manual start and stop.

Automatic control generator (supporting dry node connection): This type of generator supports automatic start-stop.

No.	Parameter	Description
1	Dry contact control mode	<p>Set switch control mode and automatic control mode. This function only takes effect for generators that support dry contact connection.</p> <ul style="list-style-type: none"> ● In switch control mode, the start and stop of the generator can be remotely controlled. If the voltage frequency of the generator meets the requirements, it will enter the oil machine mode and can be connected to the grid. In switch mode, the generator can only be shut down by remote shutdown command. ● In automatic control mode, the generator automatically starts and stops based on preset parameters. If the battery voltage/SOC reaches the generator starting conditions and is in a back-up state, the generator will be started through dry contacts. If the generator voltage and frequency meet the requirements, the generator will be allowed to go on-grid.
2	Prohibited working hours	<p>Set prohibited working hours. During this time period, the generator will stop working. After setting the prohibited working hours, the generator will not start even if other start conditions are met during this time period. If the generator is running at the time of prohibition, the off-grid inverter will shut down the generator through a dry contact point until the end of the prohibition time, and then reevaluate the start conditions. This function only applies to generators that support dry contact connections.</p>
3	Rated Power	<p>Rated power of the generator. Default setting is 6kW.</p>

4	Running time	Continuous running time of the generator. The generator will automatically shut down after exceeding the set running time. The default running time is 8 hours. This function only applies to generators that support dry node connection.
5	Upper Voltage	Set the upper limit of the operating voltage of the generator according to the local safety regulations.
6	Lower Voltage	Time mode will be activated within the time period between the opening time and the closing time. Set the lower limit of the operating voltage of the generator according to the local safety regulations.
7	Upper frequency	Set the upper limit of the operating frequency of the generator according to local safety regulations.
8	Lower Frequency	Set the lower limit of the operating frequency of the generator according to the local safety regulations.
9	Preheating time	Preheating time before loading of the generator. The default preheating time is 0 seconds.
10	Switch	Enable or disable the function of the generator charging the battery.
11	Maximum charging power.	Set the maximum charging power for the generator to charge battery.
12	Start voltage	Set start voltage for the generator to charge battery. When the battery voltage is below the set value, the generator will charge the battery.
13	Stop voltage	Set stop voltage for the generator to charge the battery. The generator will stop charging the battery when the voltage is higher than the set value.

9.8.2 Setting Load Control

Step 1: Go to **Home > Settings > Port Connection > Load Control** to enter the parameter setting interface.

Step 2: Enter the parameter values as needed, then click on the "√" to successfully set the parameters.

Dry contact mode: When the switch status is set to ON, power is supplied to the load; when the switch status is set to OFF, power supply to the load is stopped. Please set the switch status to ON or OFF according to actual needs.

Time mode: The load will automatically supply power or cut off power within the set time period. You can choose between standard mode and intelligent mode.

No.	Parameter	Description
1	Standard	The loads will be powered within the setting time period.
2	Intelligent	Once the excess energy of the photovoltaic exceeds the load nominal power within the time period, the loads will be powered.
3	Start Time	The time mode will be on between the Start Time and End Time.
4	End Time	
5	Repeat	The repeat days.
6	Load Consumption Time	The shortest time the load runs after being turned on to avoid frequent switching due to energy fluctuations. Only applicable in intelligent mode.
7	Load Rated Power	When the surplus energy generated by the photovoltaic system exceeds the rated power of the load, the power is supplied to the load. Only applicable in intelligent mode.

SOC mode: The inverter with built-in relay dry contact control port for back-up can control whether to supply power to the load through the relay. In back-up mode, if an overload or battery SOC value lower than the back-up battery protection value is detected at the BACK-UP end, power supply to the load connected to the relay port

can be stopped.

10 Monitoring Power Plant

10.1 SEMS Portal Overview

SEMS Portal App is a monitoring platform. Commonly used functions are as follows:

1. Manage the organization or User information;
2. Add and monitor the power plant information;
3. Equipment maintenance.

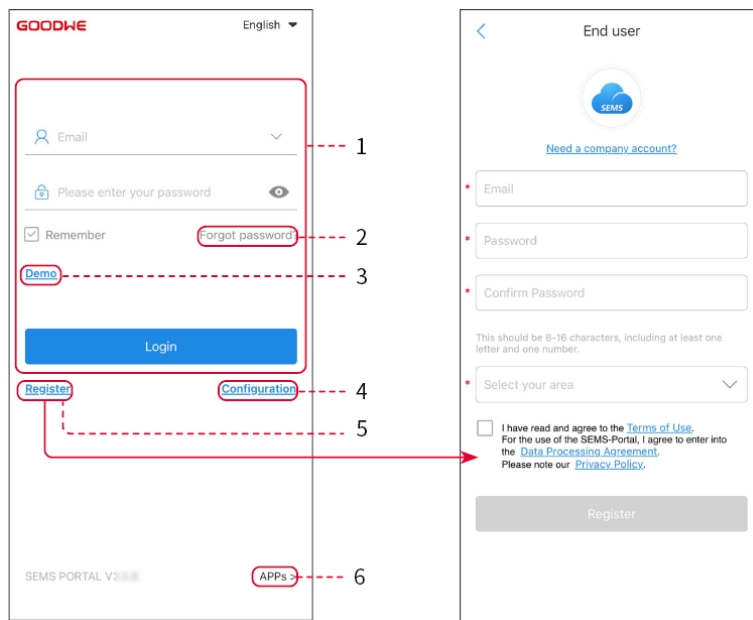

Login Page of SEMS Portal App



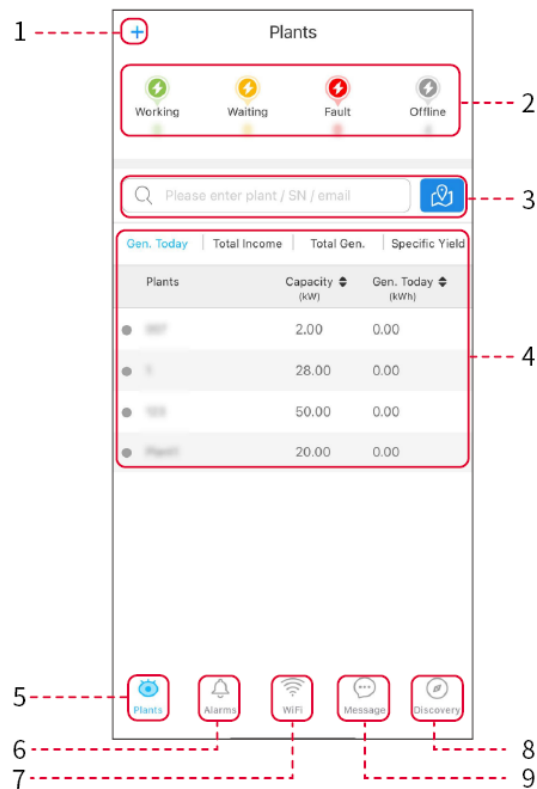

No.	Name	Description
1	Login Area	Enter the user name, password to login to the app.
2	Forget Password	Tap to reset the password by verifying the account.
3	Demo	Tap to enter the sample plant page. The sample page only displays contents with Visitor account, which is for reference only.
4	Configuration	Configure WiFi parameters to establish communication between the inverter and the server and realize remote monitoring and managing.
5	Register	Tap to register an end-user account. Contact the manufacturer or the company as prompted if you need a company account.
6	APPs	Click to obtain the SolarGo download path.

Home Page of SEMS Portal App



No.	Name	Description
1		Create a new power plant.
2	Plant status	The summary of the plants working information under the account.
3	Find the plant	Find the plant by entering the plant name, device SN, Email address, or map.
4	Generation statistics	The working information of a single plant. Tap the plant name to check the detailed information of the plant, such as plant name, location, power, capacity, generation today, total generation, etc.
5	 Plants	Plant monitoring page.
6	 Alarms	Check all alarms, happening alarms, and recovered alarms.

7	 WiFi	Complete WiFi configurations when a Wi-Fi Kit dongle is used.
8	 Message	To set and check system messages.
9	 Discovery	To edit the account, create My QR Code, set Income Settings, etc.

10.2 Manage the Plant or Devices

10.2.1 Creating Power Plant

Step 1 Enter the **Create Plant** page.

Step 2 Read the instructions and fill in the requested plant information based on actual situation. (* refers to the mandatory items)

Step 3 Follow the prompts to add devices and create the plant.

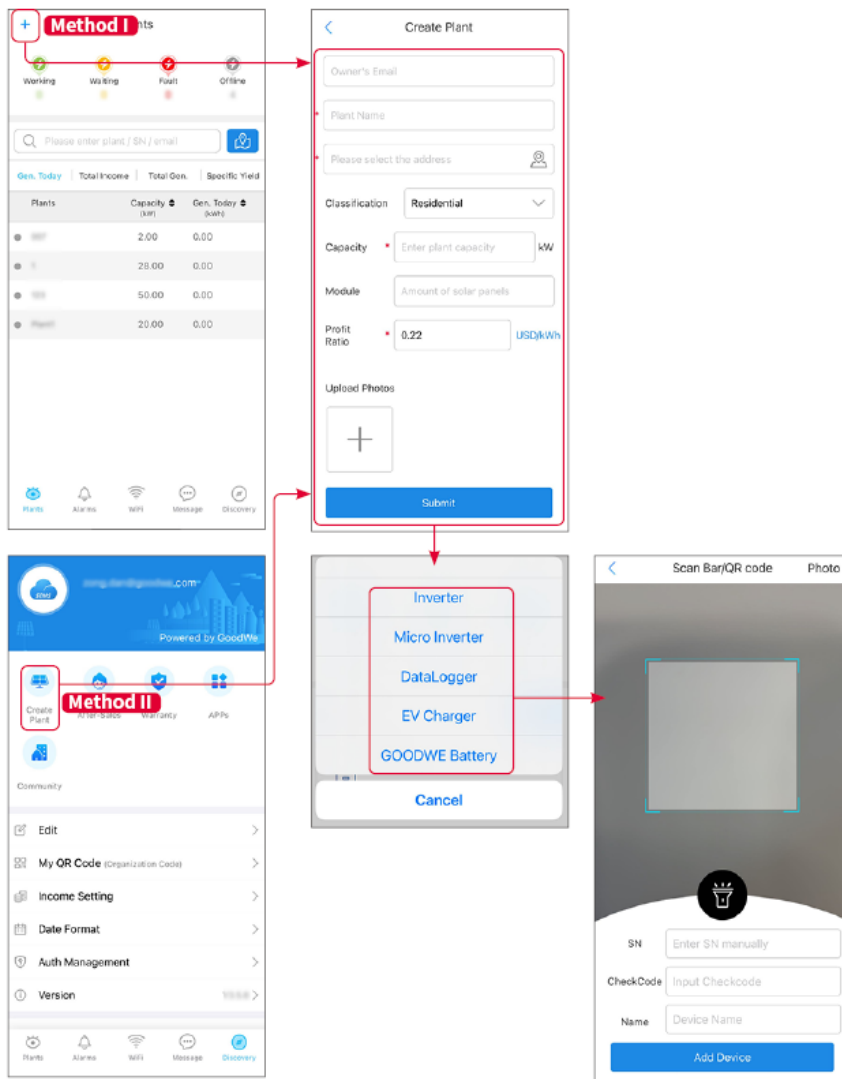

10.2.2 Managing the Plant

Step 1: Enter the power plant monitoring page and delete or modify the power plant information based on actual needs.

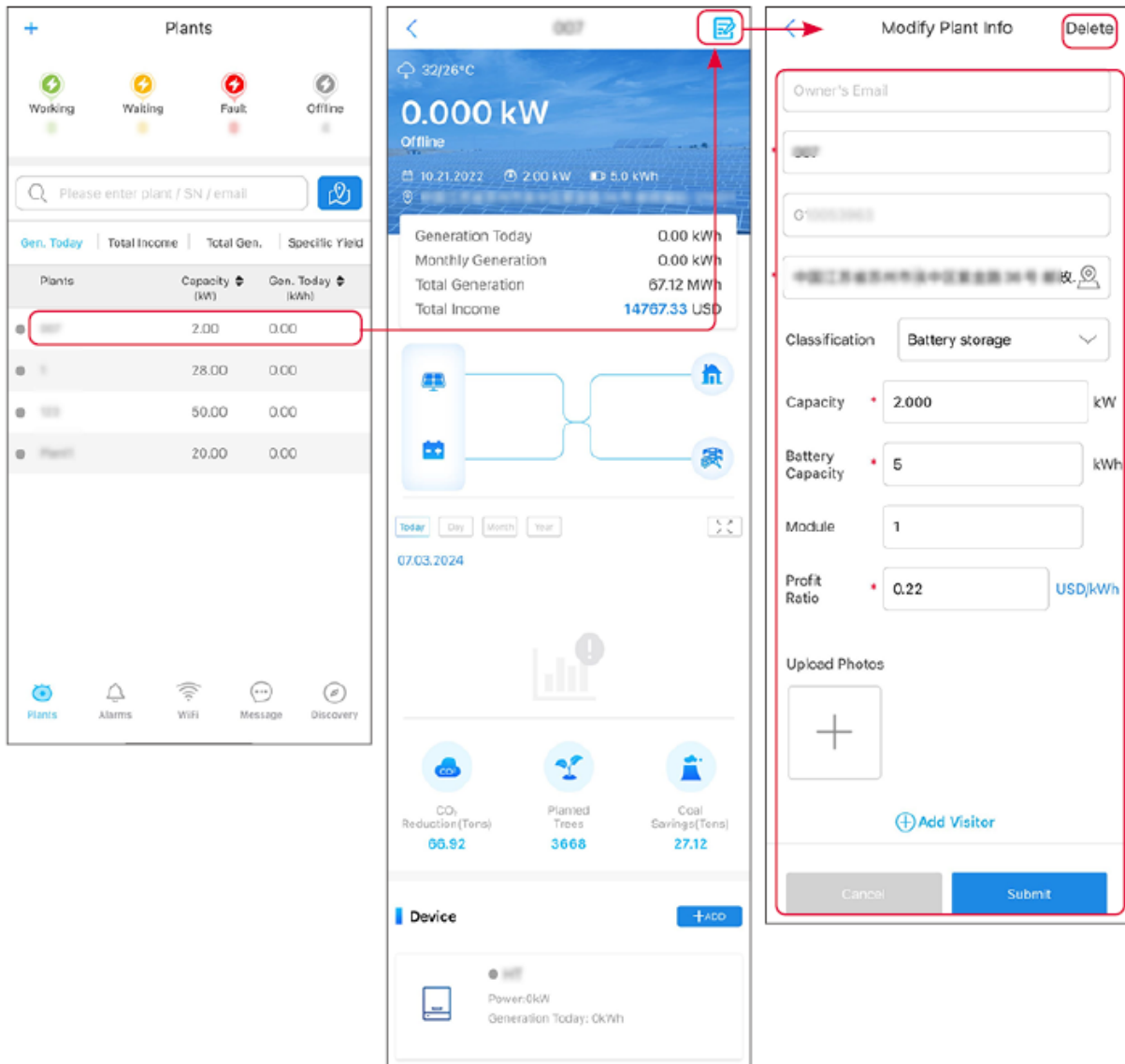

10.2.3 Managing the Devices

Step 1 Select the power plant and enter the detailed information page.

Step 2 Add, delete, or replace the devices based on actual needs.

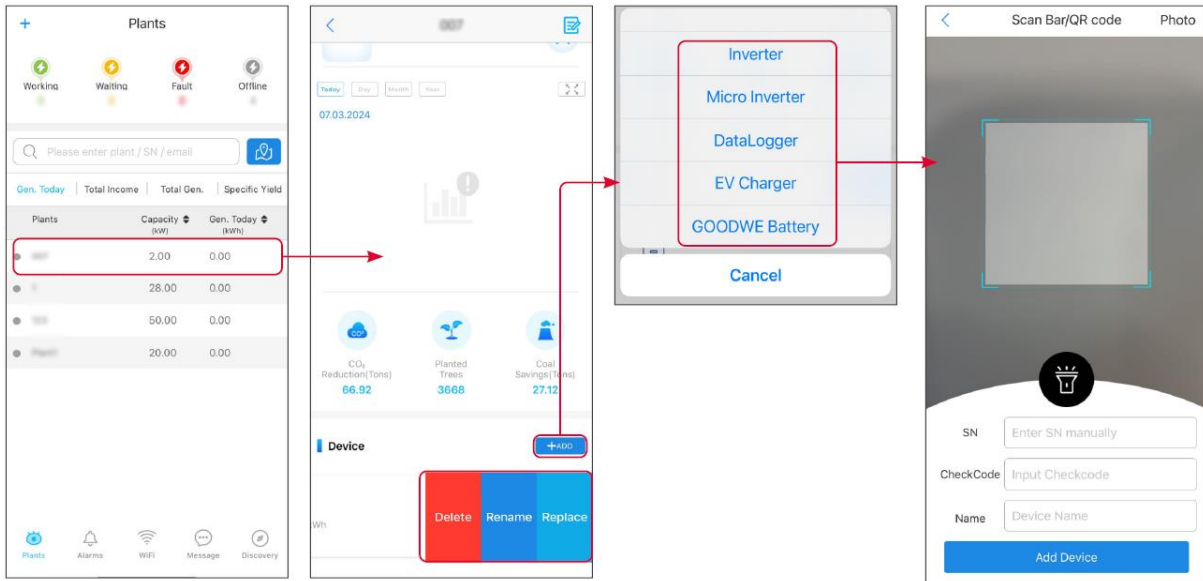

10.3 Monitoring Power Plant

10.3.1 Viewing Power Plant Information

Log in the SEMS Portal app with the account and password. The overall working situation of all power plants under this account will be displayed.

The interface varies depending on the devices.

Step 1: (Optional) Search the plant name, inverter SN, or Email to find out the plant quickly.

Or tap the map icon to search the plant.

Step 2 Tap the plant name in the plant list or the plant icon in the map to check detailed information about the plant.

Step 3 Check the plant information, power generation situation, device information, faults, etc.

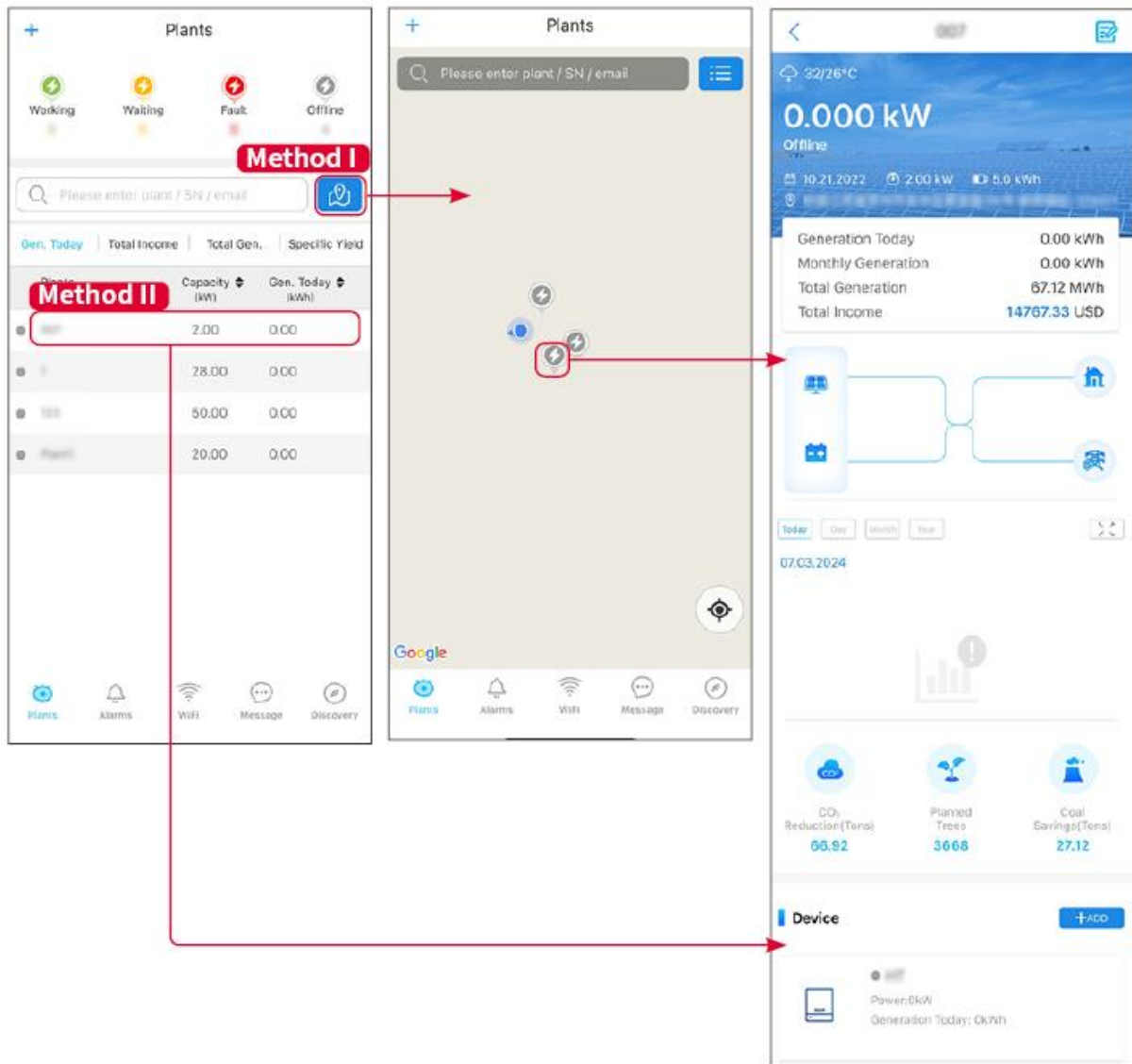

10.3.2 View Alarm Information

Step 1 Tap Alarm tab and enter the Alarm Details page.

Step 2 (optional) Enter the plant name, inverter SN, or owner's Email address in the search bar to find out the plant which is alarming.

Step 3 Tap the alarm name to check the alarm details.

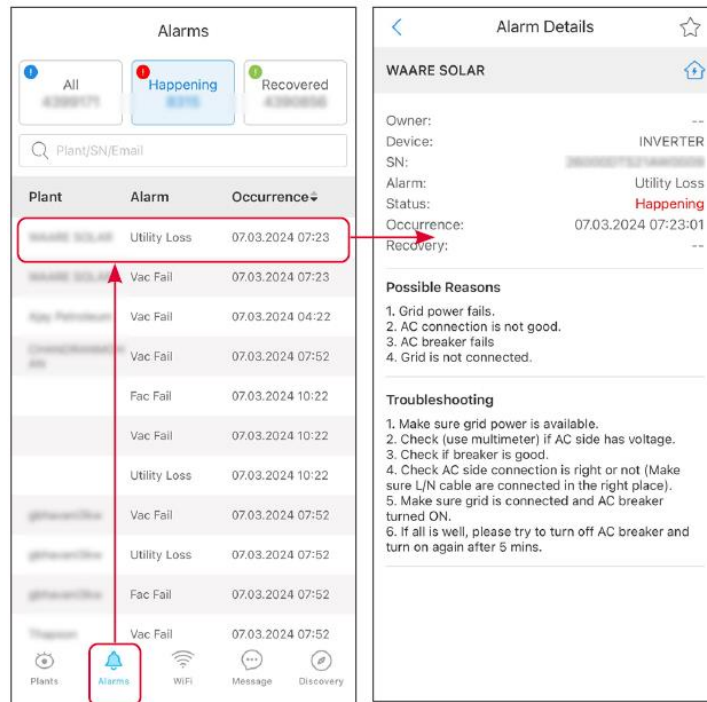

11 Maintenance

11.1 Power OFF the System



- Power off the equipment before operations and maintenance. Otherwise, the equipment may be damaged or electric shocks may occur.
- Delayed discharge. Wait until the components are discharged after power off.
- Push the air switch to restart the battery.
- Strictly follow the power off requirements to avoid damaging the system.

NOTICE

- Install the circuit breaker between the inverter and the battery or between the two batteries in compliance with local laws and regulations.
- To ensure effective protection, the cover of the battery system switch should remain closed. The cover can be closed automatically after being opened. Fasten the cover with screws if the switch is not to be used for a long-term period.

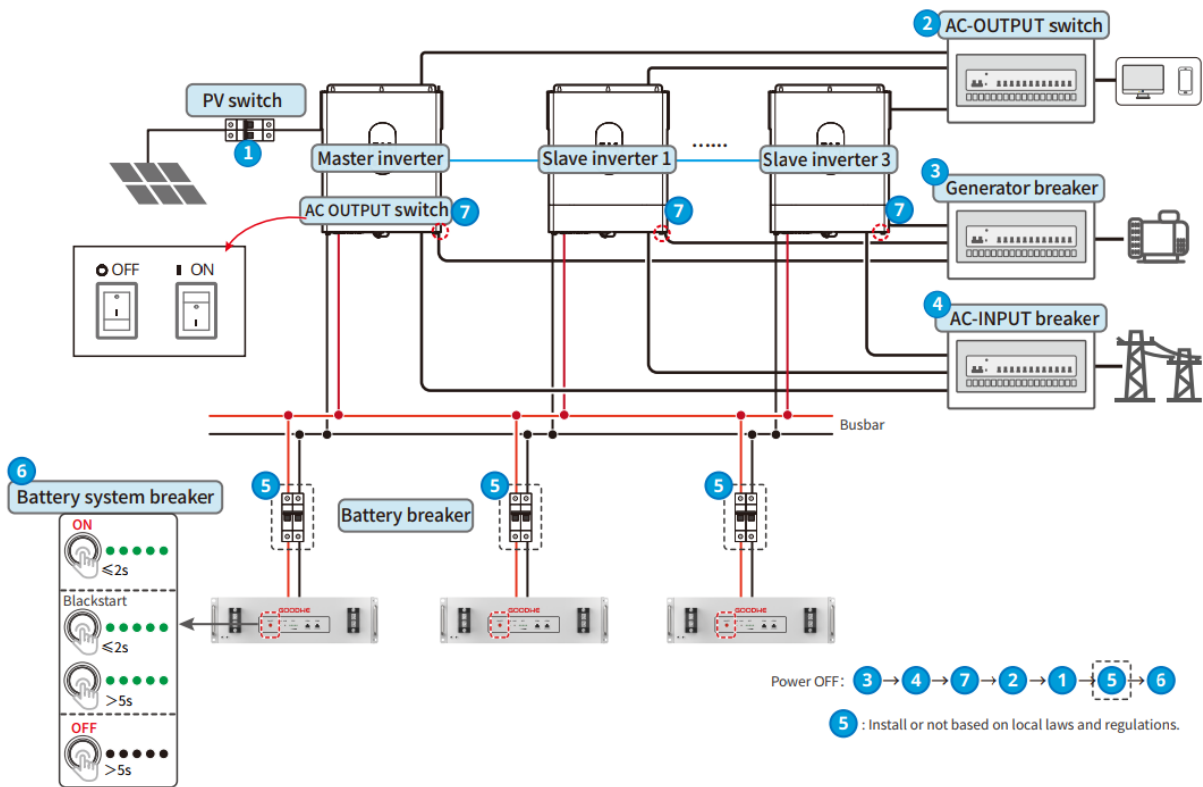
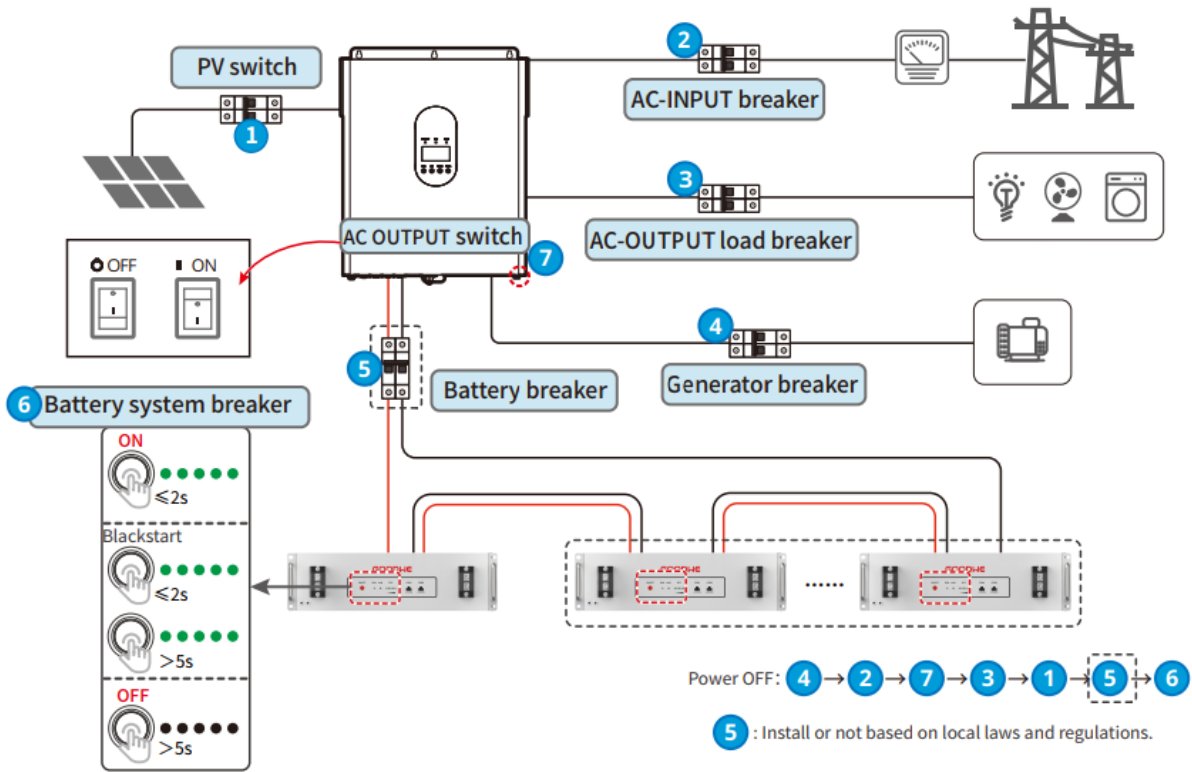

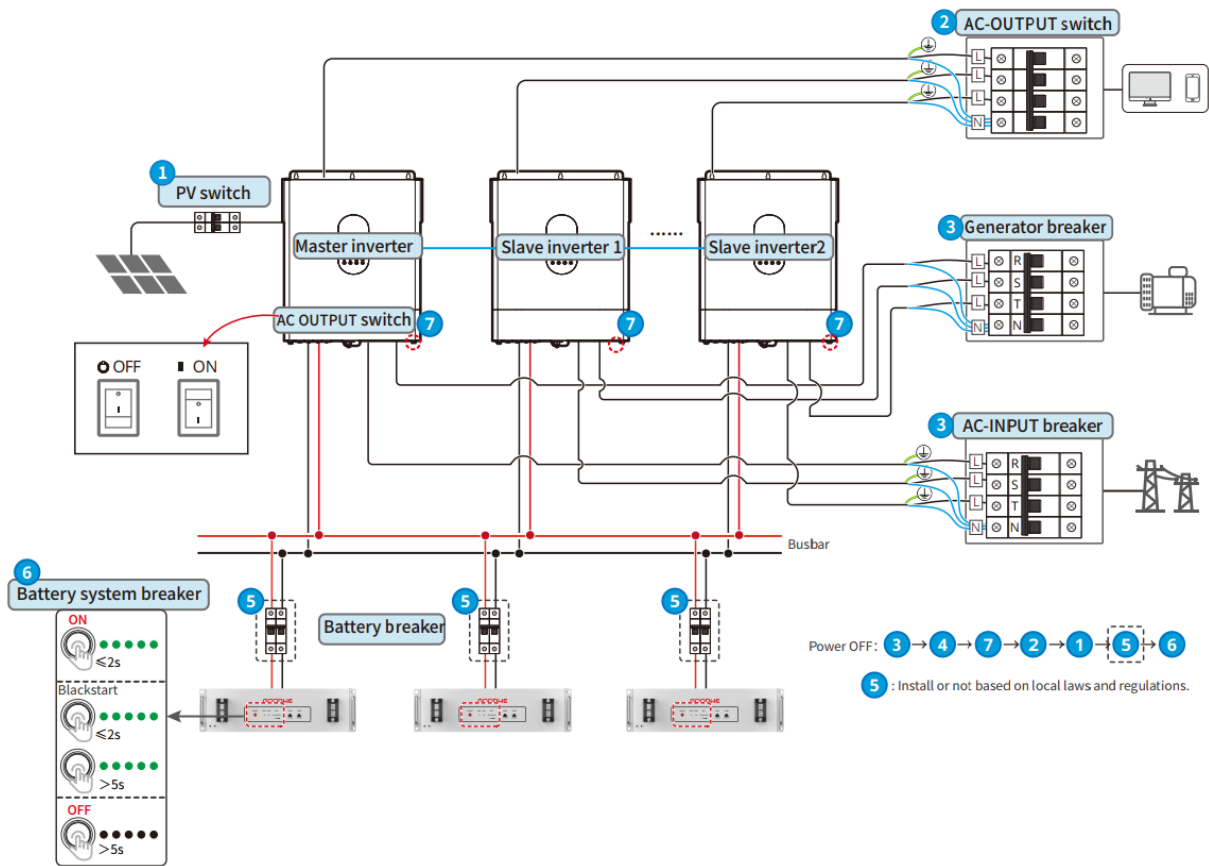

11.2 Removing the Equipment



- Make sure that the equipment is powered off.
- Wear proper personal protective equipment during operations.
- Please use standard disassembly tools when removing wiring terminals to avoid damaging the terminals or equipment.
- Unless otherwise specified, the dismantling process of the equipment is in reverse order to the installation process, and it will not be further elaborated in this document.

Step 1: Power off the system.

Step 2: Use labels to mark the types of cables connected in the system.

Step 3: Disconnect the connection cables of the back-up inverter and battery in the off-grid system, such as DC cables, AC cables, communication cables, and PE cables.

Step 4: Remove smart communication stick, back-up inverter, battery and other equipment.

Step 5: Properly store the equipment and ensure storage conditions meet the requirements if it will be used again in the future.

11.3 Disposing of the Equipment

If the equipment cannot work anymore, dispose of it according to the local disposal requirements for electrical equipment waste. The equipment cannot be disposed of together with household waste.

11.4 Routine Maintenance



- If any issues that may affect the battery or the inverter system are found, please contact the after-sales service. It is prohibited to disassemble it privately.
- Contact after-sales service for help if the copper conductor is exposed. Do not touch or disassemble privately because high voltage danger exists.
- In case of other emergencies, contact the after-sales service as soon as possible. Operate following the instructions or wait for the after-sales service personnel.

Maintaining Item	Maintaining method	Maintaining Period	Maintaining purpose
System clean	<ol style="list-style-type: none"> 1. Check the heat sink, air intake, and air outlet for foreign matter or dust. 2. Check whether the installation space meets requirements and whether there is any debris around the device. 	Once half a year	Avoid heat dissipation faults.
System installation	<ol style="list-style-type: none"> 1. Check whether the equipment are installed securely and whether the screws 	Once 6-12 months	Ensure that the equipment is installed securely.

	are installed tightly. 2. Check whether the equipment is damaged or deformed.		
Electrical connection	Check whether the cables are securely connected. Check whether the cables are broken or whether there is any exposed copper core.	Once 6-12 months	Verify the reliability of electrical connections.
Sealing	Check whether all the terminals and ports are properly sealed. Reseal the cable hole if it is not sealed or too big.	Once a year	Ensure that the equipment is sealed properly.

11.5 Troubleshooting

Perform troubleshooting according to the following methods. Contact the after-sales service if these methods do not work.

Collect the information below before contacting the after-sales service, so that the problems can be solved quickly.

1. Product information like serial number, software version, installation date, fault time, fault frequency, etc.
2. Installation environment, including weather conditions, whether the PV modules are sheltered or shadowed, etc. It is recommended to provide some photos and videos to assist in analyzing the problem.
3. Utility grid situation.

11.5.1 System Troubleshooting

No.	Cause	Solutions
1	Unable to find WFA-	1. Make sure that the Smart Dongle on the inverter

	*****/ WLA-*****	<p>is powered on and the blue indicator is flashing or steady on.</p> <ol style="list-style-type: none"> 2. Make sure that the Smart Dongle is within its communication range. 3. Refresh the device list in the app. 4. Restart the inverter 5. Quickly double-click the Reload button to turn on the Bluetooth signal.
2	Unable to connect to WFA-*****/ WLA-*****	<ol style="list-style-type: none"> 1. Ensure successful pairing of Bluetooth. 2. Ensure that no other smart devices are connected to WFA-*****/WLA-*****. 3. Restart the inverter and reconnect it to WFA-*****/WLA-*****. 4. Unpair the pairing with WFA-*****/WLA-***** in the Bluetooth settings of your phone, and then reconnect through the app.
3	Cannot find router SSID	<ol style="list-style-type: none"> 1. Put the router nearer to the Smart Dongle. Or add a WiFi relay device to enhance the WiFi signal. 2. Reduce the number of devices connected to router.
4	After completing all configurations, the Smart Dongle fails connecting to the router.	<ol style="list-style-type: none"> 1. Restart the inverter 2. Check if the SSID, encryption method and password on WiFi configuration page are the same with that of Router. 3. Restart the router. 4. Put the router nearer to the Smart Dongle. Or add a WiFi relay device to enhance the WiFi signal.
5	Cannot find router SSID	<ol style="list-style-type: none"> 1. Put the router nearer to the Smart Dongle. Or add a WiFi relay device to enhance the WiFi signal. 2. Reduce the number of devices connected to router.
6	After completing all configurations, the Smart Dongle fails connecting to the router.	<ol style="list-style-type: none"> 1. Restart the inverter. 2. Check if the SSID, encryption method and password on WiFi configuration page are the same with that of Router.

		<ol style="list-style-type: none"> 3. Restart the router. 4. Put the router nearer to the Smart Dongle. Or add a WiFi relay device to enhance the WiFi signal.
7	After completing all configurations, the Smart Dongle fails connecting to the router.	Restart the router and inverter.

11.5.2 Inverter Troubleshooting

Single inverter

No.	Fault	Fault code	Cause	Solutions
1	PV Input Overvoltage	F01	The photovoltaic array is configured incorrectly, with too many photovoltaic battery panels connected in series.	Check the series configuration of the corresponding photovoltaic array to ensure that the open-circuit voltage of the array is not higher than the maximum operating voltage of the inverter.
2	PV single software overcurrent	F02	<ol style="list-style-type: none"> 1. Component configuration is unreasonable. 2. Hardware damage. 	Disconnect the AC output switch and DC input switch, then connect them 5 minutes later. Contact the dealer or the after-sales service if the problem persists.
3	PV strings over current (Series 1~16)	F03	<ol style="list-style-type: none"> 1. Component configuration is unreasonable. 2. Hardware damage. 	Disconnect the AC output switch and DC input switch, then connect them 5 minutes later. Contact the dealer or the after-sales service if the problem persists.

4	Single PV hardware overcurrent	F04	<ol style="list-style-type: none"> 1. Component configuration is unreasonable. 2. Hardware damage. 	<p>Disconnect the AC output switch and DC input switch, then connect them 5 minutes later. Contact the dealer or the after-sales service if the problem persists.</p>
5	Boost module 1 temperature is too high.	F05	<ol style="list-style-type: none"> 1. The installation location of the inverter is not ventilated. 2. The ambient temperature is too high, exceeding 60°C. 3. Internal fan working abnormally. 	<ol style="list-style-type: none"> 1. Check whether the ventilation of the inverter installation location is good and if the ambient temperature exceeds the highest allowable range. 2. If there is poor ventilation or the ambient temperature is too high, please improve the ventilation and heat dissipation conditions. 3. Contact the dealer or after-sales service if both the ventilation and the ambient temperature are normal.
6	Cavity Overtemperature	F20	<ol style="list-style-type: none"> 1. The installation location of the inverter is not ventilated. 2. The ambient temperature is too high, exceeding 60°C. 3. Internal fan working abnormally. 	<ol style="list-style-type: none"> 1. Check whether the ventilation of the inverter installation location is good and if the ambient temperature exceeds the highest allowable range. 2. If there is poor ventilation or the ambient temperature is too high, please improve the ventilation and heat dissipation conditions. 3. Contact the dealer or after-sales service if both the ventilation and the ambient temperature are normal.
7	INV module overtemperature	F37	<ol style="list-style-type: none"> 1. The installation location of the inverter is not ventilated. 	<ol style="list-style-type: none"> 1. Check whether the ventilation of the inverter installation location is good and if the ambient temperature exceeds the highest allowable range. 2. If there is poor ventilation or the ambient

			<ol style="list-style-type: none"> 2. The ambient temperature is too high, exceeding 60°C. 3. Internal fan working abnormally. 	<p>temperature is too high, please improve the ventilation and heat dissipation conditions.</p> <ol style="list-style-type: none"> 3. Contact the dealer or after-sales service if both the ventilation and the ambient temperature are normal.
8	PV string reverse connection (Series connection 1~16)	F06	The PV strings are connected reversely.	Check whether the PV1 and PV2 strings are connected reversely.
9	BUS overvoltage (Secondary CPU1)	F17	<ol style="list-style-type: none"> 1. PV voltage is too high. 2. Inverter BUS voltage sampling abnormal. 	<p>Disconnect the AC output switch and DC input switch, then connect them 5 minutes later.</p> <p>Contact the dealer or the after-sales service if the problem persists.</p>
10	BUS overvoltage (Secondary CPU1)	F18	<ol style="list-style-type: none"> 1. PV voltage is too high. 2. Inverter BUS voltage sampling abnormal. 	<p>Disconnect the AC output switch and DC input switch, then connect them 5 minutes later.</p> <p>Contact the dealer or the after-sales service if the problem persists.</p>
11	BUS Overvoltage	F36	<ol style="list-style-type: none"> 1. PV voltage is too high. 2. Inverter BUS voltage sampling abnormal. 	<p>Disconnect the AC output switch and DC input switch, then connect them 5 minutes later.</p> <p>Contact the dealer or the after-sales service if the problem persists.</p>
12	Battery reverse connection fault	F19	The positive and negative terminals of the battery are reversed.	Check whether the battery cables are connected to inverter reversely.
13	Internal fan	F21	<ol style="list-style-type: none"> 1. Fan power 	<ol style="list-style-type: none"> 1. Check if there are any foreign objects

	abnormal		<p>supply abnormal.</p> <p>2. Mechanical failure (rotor blocked).</p> <p>3. The fan is damaged due to aging.</p>	<p>blocking the rotation of the fan.</p> <p>2. Disconnect the AC output switch and DC input switch, then connect them 5 minutes later. Contact the dealer or the after-sales service if the problem persists.</p>
14	Battery 1 software overcurrent	F22	Battery charging or discharging current triggers software protection.	Disconnect the AC output switch and DC input switch, then connect them 5 minutes later. Contact the dealer or the after-sales service if the problem persists.
15	Battery 1 over-voltage detected.	F23	The battery voltage exceeds the limit.	Disconnect the AC output switch and DC input switch, then connect them 5 minutes later. Contact the dealer or the after-sales service if the problem persists.
15	Battery 1 hardware overcurrent	F24	Battery charging or discharging current triggers hardware protection.	Disconnect the AC output switch and DC input switch, then connect them 5 minutes later. Contact the dealer or the after-sales service if the problem persists.
16	GFCI HCT Check abnormal	F33	GFCI HCT sampling abnormal	Disconnect the AC output switch and DC input switch, then connect them 5 minutes later. Contact the dealer or the after-sales service if the problem persists.
17	AC HCT Check abnormal	F34	AC HCT sampling abnormal	Disconnect the AC output switch and DC input switch, then connect them 5 minutes later. Contact the dealer or the after-sales service if the problem persists.
18	Isolation Fail	F39	<p>1. The PV string is short-circuited to PE.</p> <p>2. The PV system is in a moist environment and the cable</p>	<p>1. Check whether the resistance of the PV string to PE exceeds 50kΩ. If no, check the short circuit point.</p> <p>2. Check whether the PE cable is connected correctly.</p> <p>3. If it is confirmed that the insulation resistance is indeed lower than the default</p>

			is not well insulated to the ground.	<p>value in rainy weather, please reset the "Insulation Resistance Protection Point". Inverters for the Australian and New Zealand markets can also be alerted in the following ways in the event of insulation impedance failure:</p> <ul style="list-style-type: none"> ● The inverter is equipped with the buzzer, the buzzer sounds continuously for 1 minute in case of failure. If the fault is not resolved, the buzzer sounds every 30 minutes. ● Add the inverter to the monitoring platform, and set the alarm reminder, the alarm information can be sent to the customer by emails.
19	Off-grid output overload fault.	F41	The load power connected by the user exceeds the specified range of the inverter.	Reduce the loads on the inverter AC OUTPUT side to ensure that the load power does not exceed the maximum output power of the AC OUTPUT.
20	Off-grid output AC overvoltage fault	F42	The inverter output voltage exceeds the maximum limit of the output voltage.	Disconnect the AC output switch and DC input switch, then connect them 5 minutes later. Contact the dealer or the after-sales service if the problem persists.
	Relay Chk Fail	F43	<ol style="list-style-type: none"> 1. Relay fault (relay short circuit) 2. The control circuit is abnormal. 3. The AC cable is connected improperly, like a virtual 	Disconnect the AC output switch and DC input switch, then connect them 5 minutes later. Contact the dealer or the after-sales service if the problem persists.

			connection or short circuit.	
19	Inverter software overcurrent	F46	Excessive inverter current triggers protection.	Disconnect the AC output switch and DC input switch, then connect them 5 minutes later. Contact the dealer or the after-sales service if the problem persists.
20	R phase inverter hardware overcurrent	F47	Excessive inverter current triggers protection.	Disconnect the AC output switch and DC input switch, then connect them 5 minutes later. Contact the dealer or the after-sales service if the problem persists.
21	Grid Overvoltage	F48	The grid voltage exceeds the permissible range, or the duration of high voltage exceeds the requirement of HVRT.	<ol style="list-style-type: none"> If the problem occurs occasionally, the utility grid may be abnormal temporarily. The inverter will recover automatically after detecting that the utility grid is normal. If it occurs frequently, please check if the grid voltage is within the allowable range. <ul style="list-style-type: none"> Contact the local power company if the grid voltage exceeds the permissible range. If the voltage of the power grid is within the permissible range, it is necessary to obtain the consent of the local power company. <p>Modify the overvoltage protection threshold, HVRT or disable the overvoltage protection function after obtaining the consent of the local power company.</p> <ol style="list-style-type: none"> Check whether the AC breaker and the output cables are connected securely and correctly if the problem persists.
22	Grid Undervoltage	F49	The grid voltage exceeds the permissible range, or the duration of high voltage exceeds the requirement of HVRT.	<ol style="list-style-type: none"> If the problem occurs occasionally, the utility grid may be abnormal temporarily. The inverter will recover automatically after detecting that the utility grid is normal. If it occurs frequently, please check if the grid voltage is within the allowable range. <ul style="list-style-type: none"> Contact the local power company if the

				<p>grid voltage exceeds the permissible range.</p> <ul style="list-style-type: none"> ● If the voltage of the power grid is within the permissible range, it is necessary to obtain the consent of the local power company. <p>Modify the overvoltage protection threshold, HVRT or disable the overvoltage protection function after obtaining the consent of the local power company.</p> <p>3. Check whether the AC breaker and the output cables are connected securely and correctly if the problem persists.</p>
23	Grid Rapid Overvoltage	F50	The grid voltage is abnormal or ultrahigh.	<p>1. If the problem occurs occasionally, the utility grid may be abnormal temporarily. The inverter will recover automatically after detecting that the utility grid is normal.</p> <p>2. Check if the grid voltage is running at a high voltage for a long time. If it occurs frequently, please check if the grid voltage is within the allowable range.</p> <ul style="list-style-type: none"> ● Contact the local power company if the grid voltage exceeds the permissible range. ● Modify the grid overvoltage rapid protection threshold after obtaining the consent of the local power company if the grid voltage is within the permissible range.
24	Grid 10min Overvoltage	F51	The moving average of grid voltage in 10min exceeds the range of safety requirements.	<p>1. If the problem occurs occasionally, the utility grid may be abnormal temporarily. The inverter will recover automatically after detecting that the utility grid is normal.</p> <p>2. Check if the grid voltage is running at a high voltage for a long time. If it occurs frequently, please check if the grid voltage is within the allowable range.</p> <ul style="list-style-type: none"> ● Contact the local power company if the

				<p>grid voltage exceeds the permissible range.</p> <ul style="list-style-type: none"> ● Modify the grid overvoltage rapid protection threshold after obtaining the consent of the local power company if the grid voltage is within the permissible range.
25	Grid Overfrequency	F52	Utility grid exception. The actual grid frequency exceeds the requirement of the local grid standard.	<ol style="list-style-type: none"> 1. If the problem occurs occasionally, the utility grid may be abnormal temporarily. The inverter will recover automatically after detecting that the utility grid is normal. 2. If the problem occurs frequently, check whether the grid frequency is within the permissible range. <ul style="list-style-type: none"> ● Contact the local power company if the grid frequency exceeds the permissible range. ● Modify the overfrequency protection threshold or disable the overfrequency protection function after obtaining the consent of the local power company if the grid frequency is within the permissible range.
26	Grid Underfrequency	F53	Utility grid exception. The actual grid frequency exceeds the requirement of the local grid standard.	<ol style="list-style-type: none"> 1. If the problem occurs occasionally, the utility grid may be abnormal temporarily. The inverter will recover automatically after detecting that the utility grid is normal. 2. If the problem occurs frequently, check whether the grid frequency is within the permissible range. <ul style="list-style-type: none"> ● Contact the local power company if the grid frequency exceeds the permissible range. ● Modify the underfrequency protection threshold or disable the underfrequency protection function after obtaining the consent of the local power company if the grid frequency is within the







				permissible range.
27	Abnormal GFCI 30mA	F56	The input insulation impedance becomes low when the inverter is working.	<ol style="list-style-type: none"> 1. If the problem occurs occasionally, it may be caused by a cable exception. The inverter will recover automatically after the problem is solved. 2. Check whether the impedance between the PV string and PE is too low if the problem occurs frequently or persists.
28	Abnormal GFCI 60mA	F57	The input insulation impedance becomes low when the inverter is working.	<ol style="list-style-type: none"> 1. If the problem occurs occasionally, it may be caused by a cable exception. The inverter will recover automatically after the problem is solved. 2. Check whether the impedance between the PV string and PE is too low if the problem occurs frequently or persists.
29	Abnormal GFCI 150mA	F58	The input insulation impedance becomes low when the inverter is working.	<ol style="list-style-type: none"> 1. If the problem occurs occasionally, it may be caused by a cable exception. The inverter will recover automatically after the problem is solved. 2. Check whether the impedance between the PV string and PE is too low if the problem occurs frequently or persists.
30	Abnormal GFCI	F59	The input insulation impedance becomes low when the inverter is working.	<ol style="list-style-type: none"> 1. If the problem occurs occasionally, it may be caused by a cable exception. The inverter will recover automatically after the problem is solved. 2. Check whether the impedance between the PV string and PE is too low if the problem occurs frequently or persists.
31	AC output undervoltage fault	A19	<ol style="list-style-type: none"> 1. The inverter output voltage is lower than the minimum limit of the output voltage. 2. Hardware 	<p>Disconnect the AC output switch and DC input switch, then connect them 5 minutes later. Contact the dealer or the after-sales service if the problem persists.</p>













			damage.	
32	<p>Auxiliary DSP1 CAN module error.</p> <p>Main DSP CAN module error.</p> <p>Main DSP communication timeout - Auxiliary DSP1</p> <p>Auxiliary DSP1 communication timeout - Main DSP</p>	<p>A04</p> <p>A22</p> <p>A05</p> <p>A22</p>	<p>1. CAN communication failure</p> <p>2. Main DSP communication timeout</p> <p>3. Auxiliary DSP communication timeout</p>	<p>Disconnect the AC output switch and DC input switch, then connect them 5 minutes later.</p> <p>Contact the dealer or the after-sales service if the problem persists.</p>
33	Abnormal CAN communication in parallel system	A21	The connection of the parallel communication cable is abnormal, or there is an inverter offline in the parallel system.	Check all inverters to confirm whether they have been powered on, and also check if the parallel communication cables are securely connected.
34	Flash Fault	A18	Internal storage flash abnormal	Disconnect the AC output switch and DC input switch, then connect them 5 minutes later. Contact the dealer or the after-sales service if the problem persists.
35	AFCI Fault	Fault not defined.	<p>1. The DC string connector is not firmly connected.</p> <p>2. The DC cable</p>	Please check if the cables of components are correctly connected according to the wiring requirements in the quick installation guide.





			is damaged.	
36	AFCI Self-test Fault	Fault not defined.	Abnormal arc detection device	Disconnect the AC output switch and DC input switch, then connect them 5 minutes later. Contact the dealer or the after-sales service if the problem persists.

11.5.3 Battery Fault (Lynx home A)

 When the battery ALM indicator turns red, troubleshoot the issue by referring to the SOC indicator's display status.

No.	SOC indicator	Fault	Solutions
1		Battery Overvoltage	Power off and wait for 2 hours. If the problem persists, please contact the after-sales service.
2		Battery Undervoltage	Contact the after-sales service.
3		High Cell Temperature	Power off and wait for 2 hours. If the problem persists, please contact the after-sales service.
4		Low Charging Temperature	Turn off the device to wait for the temperature to return to normal. If the problem persists after restarting, please contact the after-sales service.
5		Low Discharging Temperature	Turn off the device to wait for the temperature to return to normal. If the problem persists after restarting, please contact the after-sales service.
6		Overcurrent Charging	Restart the battery. If the problem persists, please contact the after-sales service.
7		Overcurrent	Restart the battery. If the problem persists,

		Discharging	please contact the after-sales service.
8		Low Insulation Resistance	Contact the after-sales service.
9		Excessive Temperature Difference	Power off and wait for 2 hours. If the problem persists, please contact the after-sales service.
10		Voltage Difference Exception	Power off and wait for 2 hours. If the problem persists, please contact the after-sale service.
11		Inconsistency of Battery Cells	Contact the after-sales service.
12		Wire Harness Exception	Restart the battery. If the problem persists, please contact the after-sales service.
13		MOS Open-Circuit Fault	Restart the battery. If the problem persists, please contact the after-sales service.
14		MOS Open-Circuit Fault	Restart the battery. If the problem persists, please contact the after-sales service.
15		Cluster Fault	Please check if the battery model matches. If it does not match, please contact the after-sales service.
16		Interlock failure	Check whether the termination resistor is installed properly and restart the battery. Contact the after-sale service if the problem persists.
17		BMU communication failure	Restart the battery. If the problem persists, please contact the after-sales service.
18		MCU Communication Fault	Restart the battery. If the problem persists, please contact the after-sales service.
19		Air Switch Adhesion	Contact the after-sales service.

20		Precharge Failure	Restart the battery. If the problem persists, please contact the after-sales service.
21		MOS Over-temperature Fault.	Power off and wait for 2 hours. If the problem persists, please contact the after-sales service.
22		Current Diverter Overtemperature	Power off and wait for 2 hours. If the problem persists, please contact the after-sales service.
23		Reverse Connection Fault	Contact the after-sales service.
24		Microelectronic Fault	Contact the after-sales service.

12 Parameters

12.1 Inverter Parameters

Technical Parameters	GW3500L-EO-BR	GW6000-EO
Battery Input		
Type	Li-Ion/Lead-acid	Li-Ion/Lead-acid
Nominal Battery Voltage (V)	48	48
Battery Voltage Range (V)	40~60	40~60
Start-up Voltage (V)	36	36
Number of Battery Input	1	1
Max. Continuous Charging Current (A)	120	120
Max. Continuous Discharging Current (A)	78	140
Max. Charging Power (W)	6,000	6,000
Max. Discharging Power (W)	3,900	6,700
PV Input		
Max. Input Power (W)	6,600	6,600
Max. Input Voltage (V)	500	500
MPPT Operating Voltage Range (V)	120~450	120~450
MPPT Voltage Range at Nominal Power (V)	150~450	200~450

Start-up Voltage (V)	120	120
Nominal Input Voltage (V)	360	360
Max. Input Current per MPPT (A)	30	30
Max. Short Circuit Current per MPPT (A)	37.5	37.5
Max. Backfeed Current to The Array (A)	0	0
Number of MPPT Trackers	1	1
Number of Strings per MPPT	2	2
AC Input		
Max. Apparent Power from Utility Grid (VA)	4,445	8,050
Nominal Input Apparent Power (VA)	3,500	6,000
Nominal Input Voltage (V)	127	220/230
Input Voltage Range (V)	90~165	90~280
Nominal Input Frequency (Hz)	50/60	50/60
Frequency Range (Hz)	45~65	45~65
Nominal Input Current (A)	27.6	26.1
Max. Input Current (A)	35	35
AC Output		
Nominal Apparent	3,500	6,000

Power (VA)		
Nominal Output Power (W)	3,500	6,000
Max. Output Apparent Power (VA) * 4	3,500 (7,000 at 5sec)	6,000 (12,000 at 5sec)
Max. Output Power (W)	3,500 (7,000 at 5sec)	6,000 (12,000 at 5sec)
Nominal Output Current (A)	27.6	26.1
Max. Output Current (A)	27.6 (55.2 at 5sec)	27.6 (55.2 at 5sec)
Max. Output Fault Current (Peak and Duration) (A)	100 (156 μ s)	100 (156 μ s)
Inrush Current (Peak and Duration) (A)	100 (156 μ s)	100 (156 μ s)
Max. Output Overcurrent Protection	100	100
Nominal Output Voltage (V)	127	220/230
Nominal Output Voltage Frequency (Hz)	50/60	50/60
Output THDV (@Linear Load)	<3%	<3%
Switching from Grid Connected Mode to Standalone Mode	<10ms typical; <20ms Max	<10ms typical; <20ms Max
Switching from standalone mode to network connected mode	<10ms typical; <20ms Max	<10ms typical; <20ms Max
Transfer time	<10ms typical; <20ms Max	<10ms typical; <20ms Max

Output Power Factor	P.F:~1,0.8cap...0.8ind	P.F:~1,0.8cap...0.8ind
AC Data (Generator)		
Nominal Input Apparent Power (VA)	3,500	6,000
Max. Input Apparent Power (VA)	4,445	8,050
Nominal Input Voltage (V)	127	220/230
Input Voltage Range (V)	90~165	90~280
Nominal AC generator Frequency (Hz)	50/60	50/60
AC generator Frequency Range (Hz)	45~65	45~65
Max. AC Current From AC generator (A)	35	26.1
Nominal AC Current From AC generator (A)	27.6	45.5/43.5/41.7
Efficiency		
Max. Efficiency	≥94.2%	≥97%
European Efficiency	≥91.5%	≥94.7%
CEC Efficiency	≥92.1%	≥94.9%
Max. Battery to AC Efficiency	≥92.5%	≥94%
MPPT Efficiency	≥98.4%	≥99%
Protection		
PV String Current Monitoring	Integrated	Integrated
PV Insulation Resistance Detection	Integrated	Integrated

Residual Current Monitoring	Integrated	Integrated
Battery Reverse Polarity Protection	Integrated	Integrated
AC Overcurrent Protection	Integrated	Integrated
AC Short Circuit Protection	Integrated	Integrated
AC Overvoltage Protection	Integrated	Integrated
DC Surge Protection	Type III	Type III
AC Surge Protection	Type III	Type III
AFCI	Integrated	Optional
General Data		
Operating Temperature Range (°C)	-10~+60	-10~+60
Derating Temperature (°C)	45	45
Relative Humidity	5% to 95% Relative humidity (Non-condensing)	5% to 95% Relative humidity (Non-condensing)
Max. Operating Altitude (m)	2000	2000
Cooling Method	Smart Fan Cooling	Smart Fan Cooling
User Interface	LED,LCD,USB,RS485, Dry-contact, WLAN+APP	LED,LCD,USB,RS485, Dry-contact, WLAN+APP
Communication with BMS	RS485,CAN	RS485,CAN
Communication with Portal	RS485	RS485
Communication with	WiFi/LAN/BLU	WiFi/LAN/BLU

Portal		
Weight (Kg)	13	13
Dimension (W×H×D mm)	400*495*130	400*495*130
Noise Emission (dB)	<55	<55
Topology	PV: Non-isolated, BAT: Isolated	PV: Non-isolated, BAT: Isolated
Self-consumption at Night (W)	<15	<15
No Load Power Consumption (W)	≤30	≤30
Ingress Protection Rating	IP21	IP21
DC connector	BAT: Copper Bar(T=2.0) PV: Terminal(4pin*12.5)	BAT: Copper Bar(T=2.0) PV: Terminal(4pin*12.5)
AC Connector	Terminal(7pin*12.5)	Terminal(7pin*12.5)
Environmental Category	3K5	3K5
Pollution Degree	PD2*1	PD2*1
Overvoltage Category	DC II / AC III	DC II / AC III
Ingress Protection Rating	I	I
Storage Temperature (°C)	-25~+60	-25~+60
The Decisive Voltage Class (DVC)	Battery: A PV: C AC: C COM: A	Battery: A PV: C AC: C COM: A
Mounting Method	Wall Mounted	Wall Mounted
Type of Electrical	TN-S, TN-C, TN-C-S, TT	TN-S, TN-C, TN-C-S, TT

Supply System		
Country of Manufacture	China	China

12.2 Battery Technical Data

Technical Parameters	LX A5.0-10	2*LX A5.0-10	n*LX A5.0-10
Usable Energy (kWh) *1	5	10	n×5
Battery Module	LX A5.0-10: 51.2V 5.0kWh		
Number of Modules	1	2	n
Cell Type	LFP (LiFePO ₄)		
Nominal Voltage (V)	51.2		
Operating Voltage Range (V)	47.5~57.6		
Nominal Charge/Discharge Current (A) *2	60	120	n×60 ^{*3}
Nominal Charge/Discharge Power (kW) *2	3	6	n×3 ^{*3}
Operating Temperature Range (°C)	Charge: 0 ~ +50; Discharge: -10 ~ +50		
Relative Humidity	0~95%		
Max. Operating Altitude (m)	3000		
Communication	CAN		
Weight (Kg)	40	80	n×40
Dimensions (W x H x D mm)	Single LX A5.0-10 module: 442×133×420 (without handle); 483×133×452 (with handle)		
Ingress Protection Rating	IP21		
Storage Temperature (°C)	0 ~ +35 (≤1 year); -20 ~ 0 (≤1 month); -40 ~ 45 (≤1 month)		

Mounting Method	Rack mounted/Ground mounted	
Round-trip Efficiency	95%	
Standard and Certification	Safety	IEC62619, IEC 63056, IEC62040-1, INmetro
	EMC	EN IEC61000-6-1, EN IEC61000-6-2, EN IEC61000-6-3, EN IEC61000-6-4
	Transportation	UN38.3, ADR
<p>*1: Test conditions, 100% DOD, 0.2°C charge & discharge at +25±2 °C for battery system at beginning life. System Usable Energy may vary with different Inverter.</p> <p>*2: The nominal charge and discharge current and power are affected by temperature and SOC status.</p> <p>3: Under the condition of using busbar box to achieve parallel connection of batteries.</p> <p>*4: New battery, within the range of 2.5~3.65V, at the temperature range of 25+2°C, under the condition of 0.2C/0.2C charge and discharge. The efficiency is 94%~95% under the charging and discharging condition of 0.6C/0.6C.</p> <p>n: n≤15.</p>		

12.3 Smart Dongle Technical Data

Technical Parameters		WiFi/LAN Kit-20
Output Voltage (V)		5
Power Consumption (W)		≤2
Communication Interface		USB
Communication Parameters	Ethernet	10M/100Mbps Self-adaption
	Wireless	IEEE 802.11 b/g/n @2.4 GHz
	Bluetooth	Bluetooth V4.2 BR/EDR and Bluetooth LE standards.
Mechanical Parameters	Dimensions (W x H x D mm)	48.3*159.5*32.1
	Weight (g)	82
	Ingress Protection Rating	IP65

	Mounting Method	USB port insertion and removal
Operating Temperature Range (°C)		-30~+60
Storage Temperature Range (°C)		-40~+70
Relative Humidity		0-95%
Max. Operating Altitude (m)		4000

13 Appendix

13.1 FAQ

13.1.1 How to upgrade device version

Through the firmware information, you can view or upgrade the DSP version, ARM version, BMS version, and communication module software version of the inverter. Some smart dongles do not support software version upgrade via SolarGo App, and the actual situation shall prevail.

Upgrade prompt:

When the user opens the APP, an upgrade prompt will pop up on the homepage, and the user can choose whether to upgrade or not. If you choose to upgrade, you can complete the upgrade by following the prompts on the interface.

Regular upgrade:

Step 1: Go to **Home > Settings > Firmware Information** to enter the firmware information viewing interface.

Step 2: Click on **Check for Updates**, and if there is a new version, complete the upgrade according to the prompts on the interface.

Compulsory upgrade:

The APP will push upgrade information, and users need to upgrade according to the prompts; otherwise, you will not be able to use the APP. You can complete the upgrade by following the prompts on the interface.

13.2 Abbreviations

Abbreviation	Full Name
U_{batt}	Battery Voltage Range
$U_{batt,r}$	Nominal Battery Voltage

$I_{batt,max (C/D)}$	Max. Continuous Charging Current Max. Continuous Discharging Current
$E_{C,R}$	Rated Energy
U_{DCmax}	Max. Input Voltage
U_{MPP}	MPPT Operating Voltage Range
$I_{DC,max}$	Max. Input Current per MPPT
$I_{SC PV}$	Max. Short Circuit Current per MPPT
$P_{AC,r}$	Nominal Output Power
S_r (to grid)	Nominal Apparent Power Output to Utility Grid
S_{max} (to grid)	Max. Apparent Power Output to Utility Grid
S_r (from grid)	Nominal Apparent Power from Utility Grid
S_{max} (from grid)	Max. Apparent Power from Utility Grid
$U_{AC,r}$	Nominal Output Voltage
$f_{AC,r}$	Nominal AC Grid Frequency
$I_{AC,max(to grid)}$	Max. AC Current Output to Utility Grid
$I_{AC,max(from grid)}$	Max. AC Current From Utility Grid
P.F.	Power Factor
S_r	Back-up Nominal Apparent Power
S_{max}	Max. Output Apparent Power (VA) Max. Output Apparent Power without Grid
$I_{AC,max}$	Max. Output Current
$U_{AC,r}$	Nominal Output Voltage
$f_{AC,r}$	Nominal Output Frequency
$T_{operating}$	Operating Temperature Range
$I_{DC,max}$	Max. Input Current
U_{DC}	Input Voltage
$U_{DC,r}$	DC Power Supply
U_{AC}	Power Supply/AC Power Supply
$U_{AC,r}$	Power Supply/Input Voltage Range
$T_{operating}$	Operating Temperature Range
P_{max}	Max Output Power
P_{RF}	TX Power

P_D	Power Consumption
$P_{AC,r}$	Power Consumption
F (Hz)	Frequency
$I_{SC\ PV}$	Max. Input Short Circuit Current
$U_{dcmin}-U_{dcmax}$	Range of input Operating Voltage
$U_{AC,rang(L-N)}$	Power Supply Input Voltage
$U_{sys,max}$	Max System Voltage
$H_{altitude,max}$	Max. Operating Altitude
PF	Power Factor
THDi	Total Harmonic Distortion of Current
THDv	Total Harmonic Distortion of Voltage
C&I	Commercial & Industrial
SEMS	Smart Energy Management System
MPPT	Maximum Power Point Tracking
PID	Potential-Induced Degradation
Voc	Open-Circuit Voltage
Anti PID	Anti-PID
PID Recovery	PID Recovery
PLC	Power-line Communication
Modbus TCP/IP	Modbus Transmission Control / Internet Protocol
Modbus RTU	Modbus Remote Terminal Unit
SCR	Short-Circuit Ratio
UPS	Uninterruptable Power Supply
ECO mode	Economical Mode
TOU	Time of Use
ESS	Energy Storage System
PCS	Power Conversion System
RSD	Remote shutdown
EPO	Emergency Power Off
SPD	Surge Protection Device
ARC	zero injection/zero export

	Power Limit / Export Power Limit
DRED	Demand Response Enabling Device
RCR	Ripple Control Receiver
AFCI	AFCI
GFCI	Ground Fault Circuit Interrupter
RCMU	Residual Current Monitoring Unit
FRT	Fault Ride Through
HVRT	High Voltage Ride Through
LVRT	Low Voltage Ride Through
EMS	Energy Management System
BMS	Battery Management System
BMU	Battery Measure Unit
BCU	Battery Control Unit
SOC	State of Charge
SOH	State of Health
SOE	State Of Energy
SOP	State Of Power
SOF	State Of Function
SOS	State Of Safety
DOD	Depth of discharge