

GOODWE



User Manual

Smart DataLogger
EzLogger3000C

V1.1-2024-12-30

Copyright ©GoodWe Technologies Co., Ltd., 2024. All rights reserved.

No part of this document can be reproduced or transmitted to the public platform in any form or by any means without the prior written authorization of GoodWe.

Trademarks

GOODWE and other GoodWe trademarks are trademarks of GoodWe Technologies Co.,Ltd. All other trademarks or registered trademarks mentioned in this document are owned by the company.

NOTICE

The information in this document is subject to change due to product updates or other reasons. This document cannot replace the product labels or the safety precautions unless otherwise specified. All descriptions in the document are for guidance only.

CONTENT

1	About This Manual	1
1.1	Applicable Model.....	1
1.2	Target Audience.....	1
1.3	Symbol Definition.....	1
2	Safety Precaution	2
2.1	General Safety	2
2.3	Grounding Safety	2
2.4	Personal Safety.....	2
2.5	Equipment Safety	2
2.6	Warning Labels.....	3
2.7	Personnel Requirements.....	3
2.8	Declaration of Conformity.....	4
3	Product Introduction	6
3.1	Functions.....	6
3.2	Networking	6
3.3	Appearance	7
3.4	Dimensions	8
3.5	Indicators	9
3.6	Nameplate.....	9
4	Check and Storage	10
4.1	Check before Receiving	10
4.2	Storage	10
4.3	Deliverables.....	10
5	Installation	12
5.1	Installation Requirements.....	12
5.2	EzLogger Installation.....	13
5.2.1	Wall-Mounting.....	13
5.2.2	Rail-Mounting.....	14
5.2.3	Table-Mounting	14
6	Electrical Connection.....	15
6.1	Safety Precaution	15

6.2	System Wiring Diagram.....	15
6.3	Connecting the PE Cable	17
6.4	Connecting the PT Signal Cable	17
6.5	Connecting the AI Signal Cable	19
6.6	Connecting the 12V DC Output Cable	19
6.7	Connecting the DO Communication Cable	20
6.8	Connecting the DI Communication Cable.....	21
6.9	Connecting the RS485 Signal Cable	23
6.10	Connecting the Ethernet Cable	24
6.11	Connecting the 24V DC Output Cable	24
6.12	Connecting the Power Cable	25
6.13	Installing SIM Card(optional).....	26
6.14	Installing the USB Flash Drive	26
6.15	Installing the MicroSD Card	27
6.16	Installing the Antenna	27
7	Equipment Commissioning	28
7.1	Check before Power On.....	28
7.2	Power On.....	28
8	System Commissioning	29
8.1	Indicators and Buttons.....	29
8.2	Commissioning via Web	30
8.2.1	Introduction to Web UI.....	30
8.2.2	Log In.....	33
8.2.3	Setting the Network Parameters	36
8.2.4	Adding Devices	40
8.2.5	Setting EzLogger Parameters.....	46
8.2.6	Setting Inverter Parameters	47
8.2.7	Setting MV Station Parameters	54
8.2.8	Setting Smart Meter Parameters	54
8.2.9	Setting Third Party Parameters	55
8.2.10	Setting Remote Shutdown	61
8.2.11	Setting Power Control Parameters	64
8.3	Commissioning through SolarGo App.....	70
8.3.1	Downloading and Installing App.....	70
8.3.2	Login to the App.....	70

8.3.3	Introduction to the App.....	72
8.3.4	Adding Devices	73
8.3.5	Setting Inverter Parameters	78
8.3.6	Setting the Meter Parameters	86
8.3.7	Setting Power Control Parameters	87
8.3.8	Setting Network Parameters	97
9	Maintenance	101
9.1	Routine Maintenance.....	101
9.2	System Maintenance (WEB)	101
9.2.1	Upgrading	101
9.2.2	Maintaining the System	103
9.2.3	Set System Time	104
9.2.4	Change Login Password.....	104
9.3	System Maintenance (App)	105
9.3.1	System	105
9.3.2	Setting System Time	106
9.3.3	Change Login Password.....	107
9.3.4	Check EzLogger Version	107
9.4	Power Off.....	108
9.5	Removing the EzLogger	108
9.6	Disposing of the EzLogger	108
9.7	Troubleshooting	109
10	Technical Parameters	113
11	Appendix	114
11.1	FAQ.....	114
11.1.1	How to configure power limit parameters?.....	114
11.1.2	How to set IEC104 forwarding parameters?.....	114
11.1.3	How to set Modbus-TCP forwarding parameters.....	115
11.1.4	How to Export 104 Point Table	116
11.1.5	How To Add New Device After Automatic Searching.....	116

1 About This Manual

This document describes the product information, installation, electrical connection, commissioning, troubleshooting, and maintenance. Read through this document before installing and operating the product. All the installers and users have to be familiar with the product features, functions, and safety precautions. This document is subject to update without notice. For more product details and latest documents, please visit <https://en.goodwe.com>.

1.1 Applicable Model



This document applies to the Smart DataLogger EzLogger3000C (EzLogger for short).

1.2 Target Audience

This document applies to trained and knowledgeable technical professionals only. The technical personnel has to be familiar with the product, local standards, and electric systems.

1.3 Symbol Definition

Different levels of warning messages in this document are defined as follows:

 DANGER
Indicates a high-level hazard that, if not avoided, will result in death or serious injury.
 WARNING
Indicates a medium-level hazard that, if not avoided, could result in death or serious injury.
 CAUTION
Indicates a low-level hazard that, if not avoided, could result in minor or moderate injury.
NOTICE
Highlights key information and supplements the texts. Or some skills and methods to solve product-related problems to save time.

2 Safety Precaution

NOTICE

The equipment is designed and tested strictly in compliance with related safety rules. Read and follow all the safety instructions and cautions before any operations. Improper operation might cause personal injury or property damage as the equipments are electrical equipment.

2.1 General Safety

NOTICE

- The information in this document is subject to change due to product updates or other reasons. This document cannot replace the product labels or the safety precautions unless otherwise specified. All descriptions in the document are for guidance only.
- Before installations, read through this document to learn about the product and the precautions.
- All installations should be performed by trained and knowledgeable technicians who are familiar with local standards and safety regulations.
- Strictly follow the installation, operation, and configuration instructions in this document. The manufacturer shall not be liable for equipment damage or personal injury if you do not follow the instructions. For more warranty details, please visit <https://en.goodwe.com/warranty>.

2.3 Grounding Safety

DANGER

Make sure the equipment is installed at a solid and reliable place.

WARNING

Before operation, make sure the device is reliably grounded.

2.4 Personal Safety

DANGER

- Use insulating tools and wear personal protective equipment (PPE) when operating the equipment to ensure personal safety.
- Do not touch the equipment when it is short-circuited. Keep away from the equipment, and turn off the power immediately.
- Before electrical connections, disconnect all upstream switches to ensure the device is not energized.

2.5 Equipment Safety

DANGER









Make sure the equipment is installed at a solid and reliable place.

WARNING

- Use appropriate tools for proper installation, maintenance, etc.
- Comply with local standards and safety regulations when operating the equipment.
- Unauthorized disassembly or modification may cause damage to the equipment, which is not covered within the warranty scope.

2.6 Warning Labels

 DANGER	
<ul style="list-style-type: none"> All labels and warning marks should be visible after the installation. Do not cover, scrawl, or damage any label on the equipment. Labels on the equipment are as follows. 	

	HIGH VOLTAGE HAZARD. Disconnect all incoming power and turn off the product before working on it.		Potential risks exist. Wear proper PPE before any operations.
	Read through the user manual before any operations.		Do not dispose of the equipment as household waste. Discard the product in compliance with local laws and regulations, or send it back to the manufacturer.
	CE Mark		RCM Mark
	TELECOM MARK		ANATEL Mark

2.7 Personnel Requirements

NOTICE	
<ul style="list-style-type: none"> Personnel who install or maintain the equipment must be strictly trained, learn about safety precautions and correct operations. Only qualified professionals or trained personnel are allowed to install, operate, maintain, and replace the equipment or parts. 	

2.8 Declaration of Conformity

Europe

GoodWe Technologies Co., Ltd. hereby declares that the equipment with wireless communication modules sold in the European market meets the requirements of the following directives:

- Radio Equipment Directive 2014/53/EU (RED)
- Restrictions of Hazardous Substances Directive 2011/65/EU and (EU) 2015/863 (RoHS)
- Waste Electrical and Electronic Equipment 2012/19/EU
- Registration, Evaluation, Authorization and Restriction of Chemicals (EC) No 1907/2006 (REACH)

GoodWe Technologies Co., Ltd. hereby declares that the inverter without wireless communication modules sold in the European market meets the requirements of the following directives:

- Electromagnetic compatibility Directive 2014/30/EU (EMC)
- Electrical Apparatus Low Voltage Directive 2014/35/EU (LVD)
- Restrictions of Hazardous Substances Directive 2011/65/EU and (EU) 2015/863 (RoHS)
- Waste Electrical and Electronic Equipment 2012/19/EU
- Registration, Evaluation, Authorization and Restriction of Chemicals (EC) No 1907/2006 (REACH)

You can download the EU Declaration of Conformity on <https://en.goodwe.com>.

FCC

Federal Communications Commission (FCC) Interference Statement

This equipment has been tested and found to comply with the limits for a Class B digital device, pursuant to Part 15 of the FCC Rules. These limits are designed to provide reasonable protection against harmful interference in a residential installation. This equipment generate, uses and can radiate radio frequency energy and, if not installed and used in accordance with the instructions, may cause harmful interference to radio communications. However, there is no guarantee that interference will not occur in a particular installation. If this equipment does cause harmful interference to radio or television reception, which can be determined by turning the equipment off and on, the user is encouraged to try to correct the interference by one of the following measures:

- Reorient or relocate the receiving antenna.
- Increase the separation between the equipment and receiver.
- Connect the equipment into an outlet on a circuit different from that to which the receiver is connected.
- Consult the dealer or an experienced radio/TV technician for help.

This device complies with Part 15 of the FCC Rules. Operation is subject to the following two conditions:

1. This device may not cause harmful interference, and
2. this device must accept any interference received, including interference that may cause undesired operation.

FCC Caution: Any changes or modifications not expressly approved by the party responsible for compliance could void the user's authority to operate this equipment.

RF exposure warning

This equipment complies with FCC radiation exposure limits set forth for an uncontrolled

environment. This equipment must be installed and operated in accordance with provided instructions and the antenna(s) used for this transmitter must be installed to provide a separation distance of at least 20 cm from all persons and must not be collocated or operating in conjunction with any other antenna or transmitter.

ISED Canada RSS-Gen Notice

This device contains licence-exempt transmitter(s)/receiver(s) that comply with Innovation, Science and Economic Development Canada's licence-exempt RSS(s). Operation is subject to the following two conditions:

1. This device may not cause interference.
2. This device must accept any interference, including interference that may cause undesired operation of the device.

L'émetteur/récepteur exempt de licence contenu dans le présent appareil est conforme aux CNR d'Innovation, Sciences et Développement économique Canada applicables aux appareils radio exempts de licence. L'exploitation est autorisée aux deux conditions suivantes:

1. L'appareil ne doit pas produire de brouillage ;
2. L'appareil doit accepter tout brouillage radioélectrique subi, même si le brouillage est susceptible d'en compromettre le fonctionnement.

ISED Canada ICES-003 Compliance Label

This is only required if product is within ICES-003 scope and is not exempt: * Insert either "A" or "B", but not both, to identify the applicable Class of the device used for compliance verification. "CAN ICES-3 (B)/NMB-3(B)"

RF Exposure Guidance Statement

For equipment used a specified distance (more than 5mm away from persons

In order to comply with ISED RF Exposure requirements, this device must be installed to provide at least 20 cm separation from the human body at all times.

Afin de se conformer aux exigences d'exposition RF ISED, cet appareil doit être installé pour fournir au moins 20 cm de séparation du corps humain en tout temps.

This equipment should be installed and operated with minimum distance 20cm between the radiator & your body.

Lors de l'installation et du fonctionnement de cet équipement, la distance minimale entre le radiateur et le corps doit être de 20 cm

3 Product Introduction

3.1 Functions

The EzLogger is a device for the monitoring and management platform of the PV system. It can be used to collect data or logs of the inverter, environmental monitoring instrument, smart meter, etc.. The collected data will be send to the management platform to monitor, operate and maintain the PV system.

3.2 Networking

EzLogger is applicable to the PV systems over the following communication methods:

- RS485 communication, which enables communication between the EzLogger and devices like smart meters, inverters, box-type transformers, etc..
- Ethernet communication, which enables communication between the EzLogger and the router, PC and power plant monitoring system.
- 4G communication, which enables communication between the EzLogger and the power plant monitoring system.
- WiFi communication, which enables communication between the EzLogger and SolarGo App.

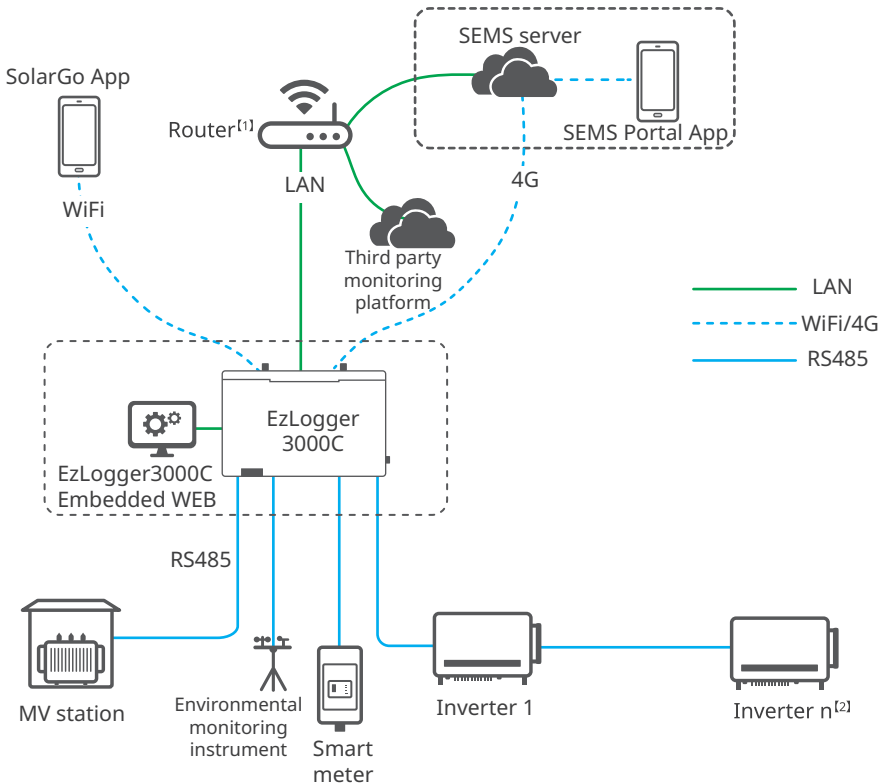

[1] Contact the after-sales service center if the router is protected by firewall.

[2] A maximum of 20 inverters can be connected to one RS485 port.

3.3 Appearance

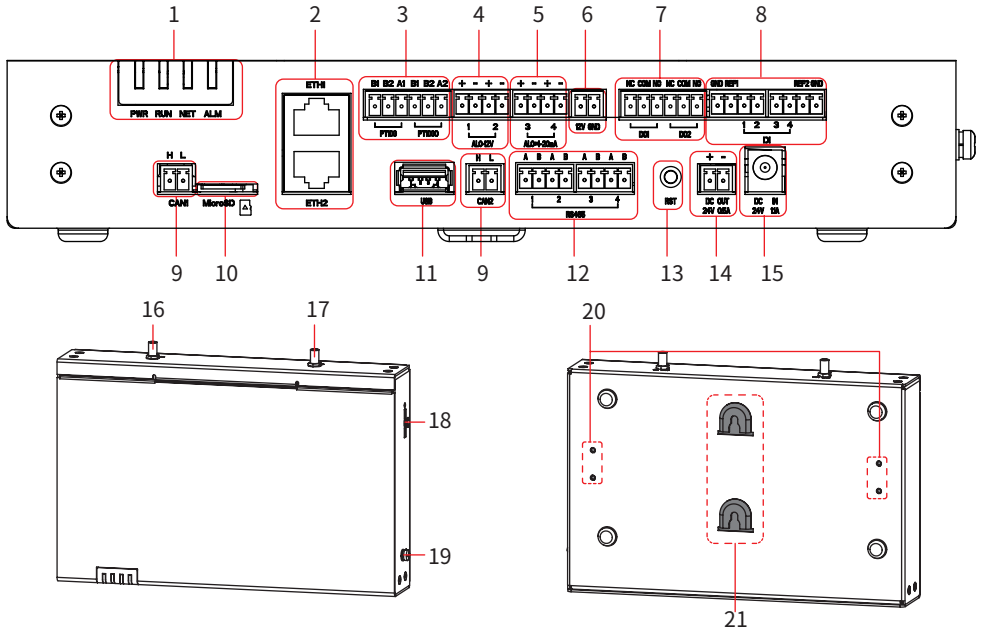







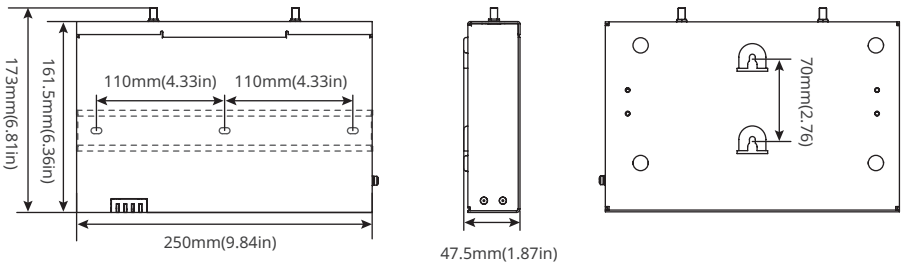

No.	Parts	Description
1	LED indicator	Indicates the equipment's working status.
2	Ethernet ports (ETH1/2)	Communication ports for the Ethernet cable. <ul style="list-style-type: none"> • ETH1: for network communication. • ETH2: for network communication and embedded web connection.
3	PT ports (PT100 PT1000)	Ports for connecting the temperature sensor.
4	AI ports (AI_0-12V)	Communication ports for 0-12V AI signal input cable.
5	AI ports (AI_0/4-20mA)	Communication ports for 0-20mA or 4-20mA AI signal input cable.
6	12V output power port (12V GND)	Supports 12V DC power input.
7	DO ports (DO1/2)	Communication ports for DO signal cable.
8	DI ports (DI)	Communication ports for DI signal cable. Supports dry contact or wet contact signal.
9	CAN ports (CAN 1/2)	Reserved ports for CAN communication.
10	MicroSD card slot (MicroSD)	Supports installing a MicroSD card to storage running, operation, and maintenance logs.
11	USB port (USB)	Connects to a USB flash drive, which can be used to update firmware version.

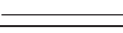
No.	Parts	Description
12	RS485 ports (RS485 1-4)	Communication ports for connecting RS485 communication cables. Supported devices: inverters, smart meters, EMIs, etc..
13	Reset button (RST)	Short press 1-3s: restart the EzLogger. Long press 6-20s: restart the EzLogger and restores factory default network settings.
14	DC output power port (DC OUT 24V 0.5A)	24V DC power output port.
15	DC input power port (DC IN 24V 1.1A)	24V DC power input port.
16	WiFi antenna port (WiFi ANT)	<ul style="list-style-type: none"> For WiFi hotspot signal. If the equipment is installed in a metal box or under a metal/concreteroof, an external antenna or RF extension cable is recommended to amplify signal. Recommended specifications of WiFi antenna: 2.4G
17	4G antenna port (4G ANT)	For 4G antenna. 4G is available in some countries and regions. Contact local distributors for more details.
18	SIM card slot (SIM)	Supports installing a SIM card for 4G communication.
19	Grounding point	Connects grounding cables to the grounding points for protection.
20	Rail clamp mounting point	Installs the equipment on the DIN rail.
21	Screw mounting slot	Hangs the equipment on screws.

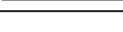
3.4 Dimensions



3.5 Indicators

Indicator	Status	Description
PWR		Steady green: The device is powered on.
		Green off: The device power supply is abnormal.
RUN		Steady green/Green off: The device fails to work.
		
NET		Slow blinking green: The device is working properly.
		Fast blinking green: Communication between the device and the router is normal, but communication between the device and the server fails.
		Slow blinking green: Communication between the device and the router fails.
ALM		Steady red: All the connected inverters are in fault status.
		Fast blinking red: the equipment is being upgraded.
		Red off: At least one inverter in the system is working properly.

3.6 Nameplate

The nameplate is for reference only.

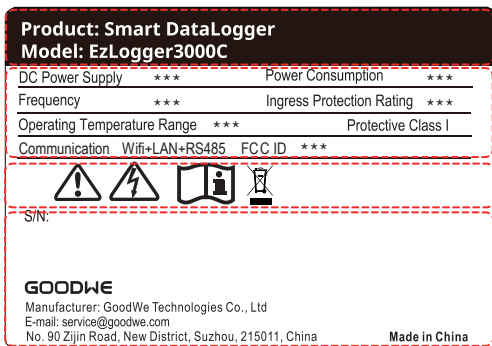

Product type and model

Technical parameters

Safety symbols

GW trademark, manufacturer and contact information

4 Check and Storage

4.1 Check before Receiving

Check the following items before receiving the product.

1. Check the outer packing box for damage, such as holes, cracks, deformation, and others signs of equipment damage. Do not unpack the package and contact the supplier as soon as possible if any damage is found.
2. Check the product model. If the product model is not what you requested, do not unpack the product and contact the supplier.
3. Check the deliverables for correct model, complete contents, and intact appearance. Contact the supplier as soon as possible if any damage is found.

4.2 Storage

If the equipment is not to be installed or used immediately, please ensure that the storage environment meets the following requirements:

1. Do not unpack the outer package or throw the desiccant away.
2. Store the equipment in a clean place. Make sure the temperature and humidity are appropriate and no condensation.
3. If the equipment has been long term stored, it should be checked by professionals before being put into use.

4.3 Deliverables

NOTICE

- Connect the cables using the included terminals. The manufacturer shall not be liable for the damage if other terminals are used.
- The actual appearance of the power adapter prevails.
- Quantity of the antenna varies depending on the product configuration.
- Number of the WiFi antenna: 1. Number of the 4G antenna (optional): 1.

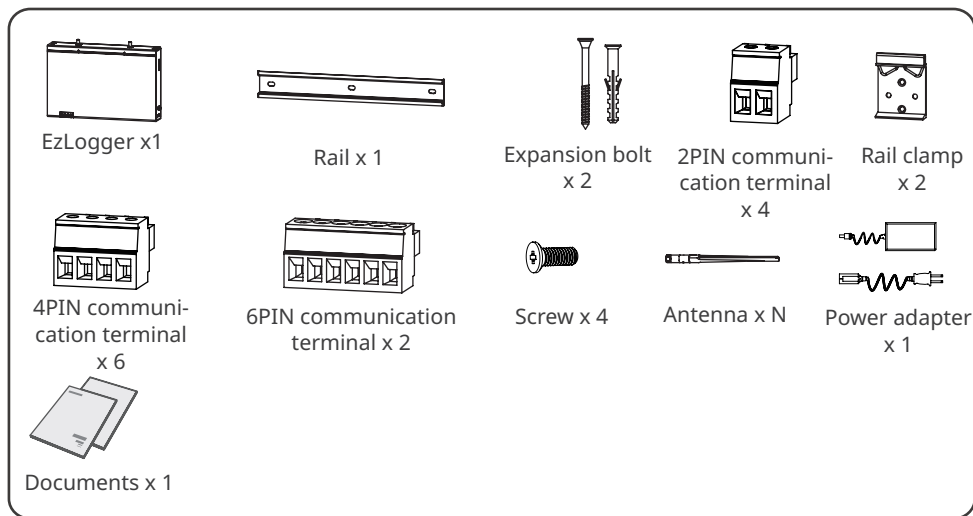

5 Installation

5.1 Installation Requirements

Installation Environment Requirements

1. Do not install the equipment in a place near flammable, explosive, or corrosive materials.
2. The place to install the equipment shall be well-ventilated for heat radiation and large enough for operations.
3. The equipment can be installed indoors. The temperature and humidity at the installation site should be within the appropriate range.
4. Do not install the equipment in a place that is easy to touch, especially within children's reach.
5. Install the equipment at a height that is convenient for operation and maintenance, electrical connections, and checking indicators and labels.
6. Install the equipment away from electromagnetic interference.

Mounting Support Requirements

- The mounting support shall be nonflammable and fireproof.
- Install the equipment on a surface that is solid enough to bear its weight.

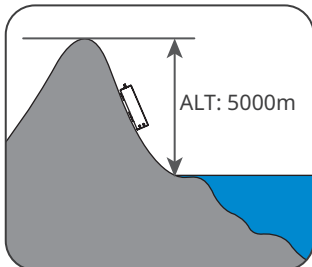
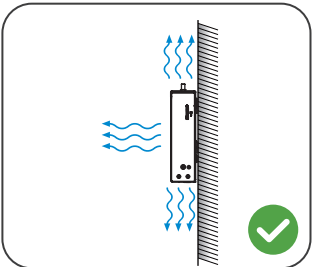
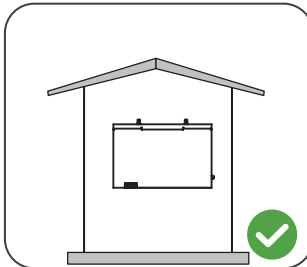
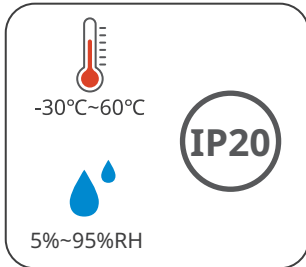
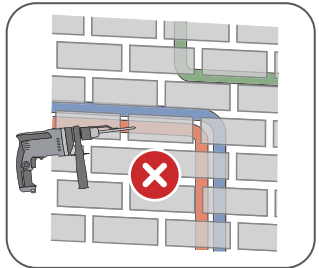
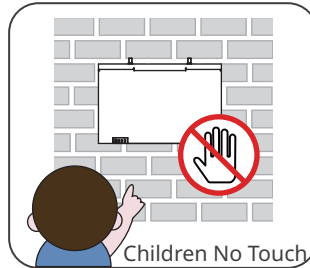
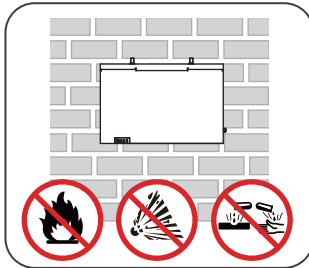

Installation Tool Requirements

The following tools are recommended when installing the equipment. Use other auxiliary tools on site if necessary.



5.2 EzLogger Installation

5.2.1 Wall-Mounting

NOTICE

- Avoid the water pipes and cables buried in the wall when drilling holes.
- Wear goggles and a dust mask to prevent the dust from being inhaled or contacting eyes when drilling holes.
- For easy connection and maintenance, ensure that the cable connection area of the EzLogger is accessible.

Step 1 Mark positions for drilling holes. Ensure that the marked holes match the mounting holes on the back of the equipment.

Step 2 Drill holes to a depth of 30mm using the hammer drill. The diameter of the drill bit should be 6mm.

Step 3 Install the expansion screws, leaving a length of 1.5-2mm outside the wall to hang the equipment.

Step 4 Hang the equipment to the expansion screws and pull it down to ensure that equipment is mounted securely.

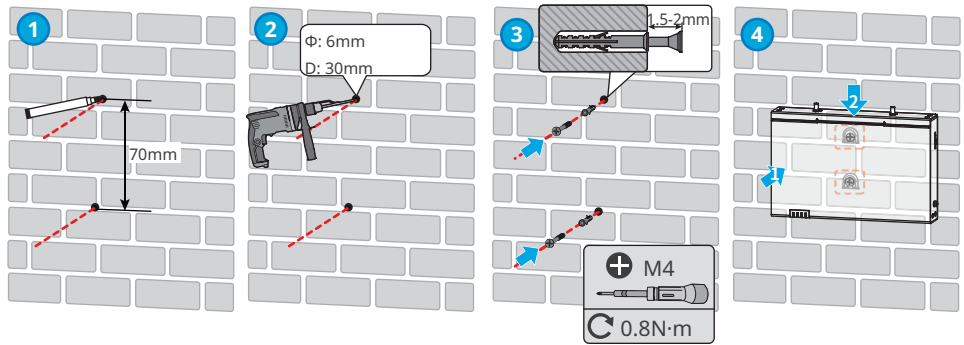

5.2.2 Rail-Mounting

NOTICE

- Screw the rail clamp to the EzLogger for rail-mounting.
- Prepare M4 screws and fix the rail on a solid and stable surface like a wall or a support.

Step 1 Screw the rail clamp to the EzLogger using M3 screws.

Step 2 Install the EzLogger to the rail.

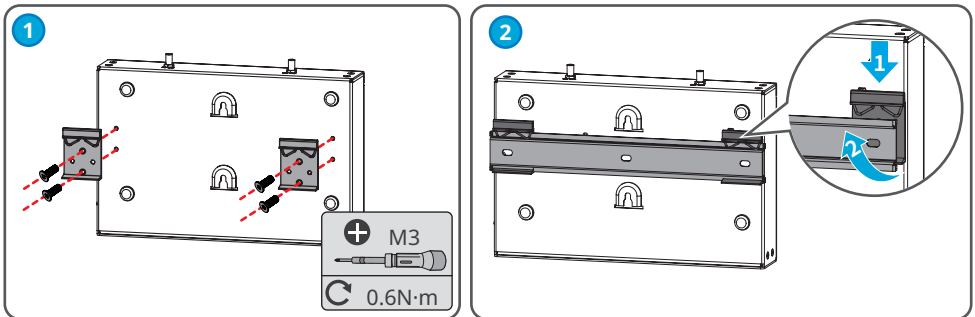

5.2.3 Table-Mounting

The EzLogger supports table installation, which means place the equipment on a desktop.

NOTICE

- Put the EzLogger on a horizontal table. Place it properly to avoid the equipment slipping and causing damage.
- Do not put the EzLogger in a place where it can be easily touched to avoid signal interruption caused by accidental touching.

6 Electrical Connection

6.1 Safety Precaution



- Before electrical connections, disconnect all upstream switches to ensure the device is not energized. Do not work with power on. Otherwise, an electric shock may occur.
- Perform electrical connections in compliance with local laws and regulations. Including operations, cables, and component specifications.
- If the cable bears too much tension, the connection may be poor. Reserve a certain length of the cable before connecting it to the equipment.

NOTICE

- Wear personal protective equipment like safety shoes, safety gloves, and insulating gloves during electrical connections.
- All electrical connections should be performed by qualified professionals.
- Cable colors in this document are for reference only. The cable specifications shall meet local laws and regulations.

No.	Cable	Silkscreen	Specification
1	PE cable		<ul style="list-style-type: none"> • Outdoor copper cable • Conductor cross-sectional area: 2.5mm² - 4mm² (14AWG - 12AWG)
2	DC output cable (12V/24V)	DC OUT / 12V GND	<ul style="list-style-type: none"> • Outdoor copper cable • Conductor cross-sectional area: 0.2mm² - 1.5mm² (24AWG - 16AWG)
3	DO signal cable	DO 1-2	
4	RS485 communication cable	RS485 1-4	<ul style="list-style-type: none"> • Shielded twisted pair cable that meets local standards • Conductor cross-sectional area: 0.2mm² - 1.5mm² (24AWG - 16AWG)
5	DI signal cable	DI 1-4	<ul style="list-style-type: none"> • Outdoor copper cable • Conductor cross-sectional area: 0.2mm² - 1.5mm² (24AWG - 16AWG)
6	AI signal cable	AI_0-12V AI_0/4-20mA	
7	PT signal cable	PT100/ PT1000	
8	Ethernet cable	ETH 1-2	<ul style="list-style-type: none"> • CAT 5E or higher specifications • Shielded RJ45 connectors

6.2 System Wiring Diagram

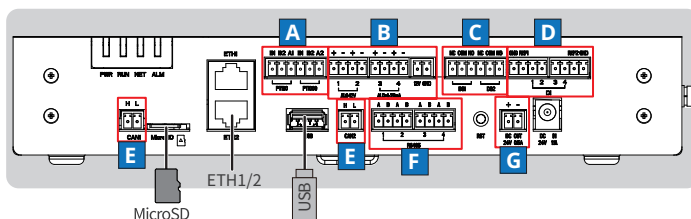

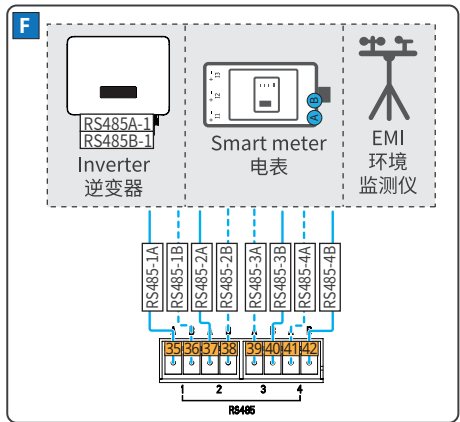
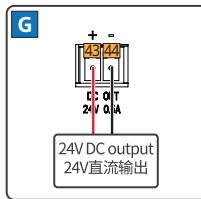
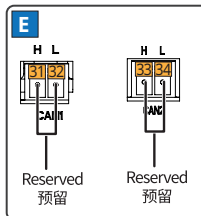
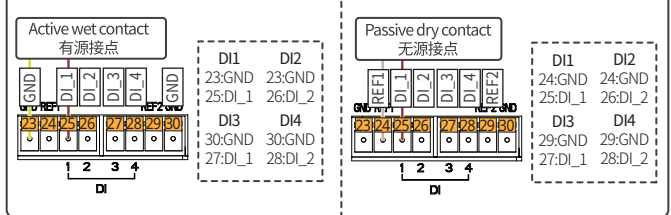
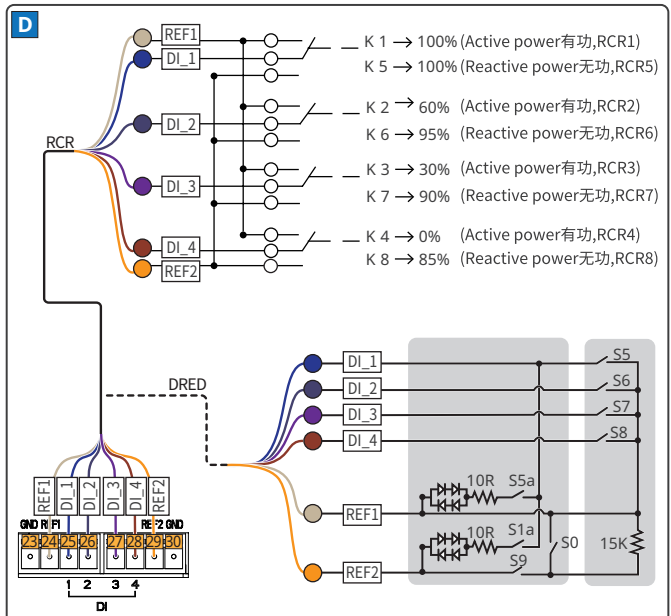
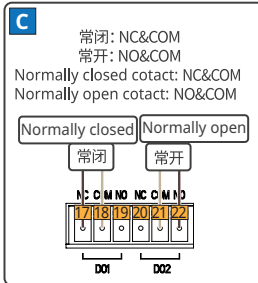
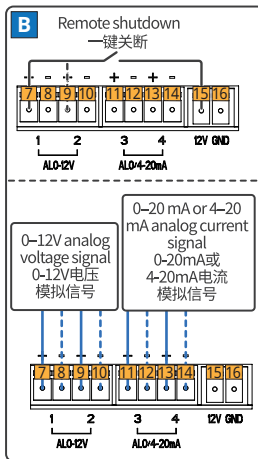
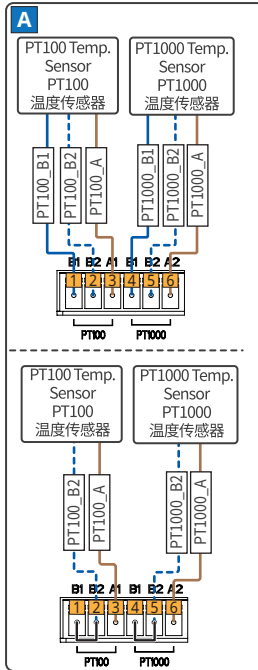

6.3 Connecting the PE Cable

WARNING

- Make sure the equipment is reliably grounded before any operations.
- To improve the corrosion resistance of the terminal, it is recommended to apply silica gel or paint on the grounding terminal after installing the PE cable.
- The PE cable, grounding OT terminal, and screw should be prepared by the customer.
Recommended specifications:
 - PE cable: outdoor copper cable with conductor cross-sectional area of 2.5-4mm²(14AWG-12AWG).
 - OT terminal: M4
 - Screw: M4

Step 1 Strip the cable to an appropriate length for insulation.

Step 2 Crimp the cable to the grounding OT terminal.

Step 3 Wrap the crimping area with insulation tube.

Step 4 Secure the PE cable to the grounding point of the EzLogger with the M4 screw.

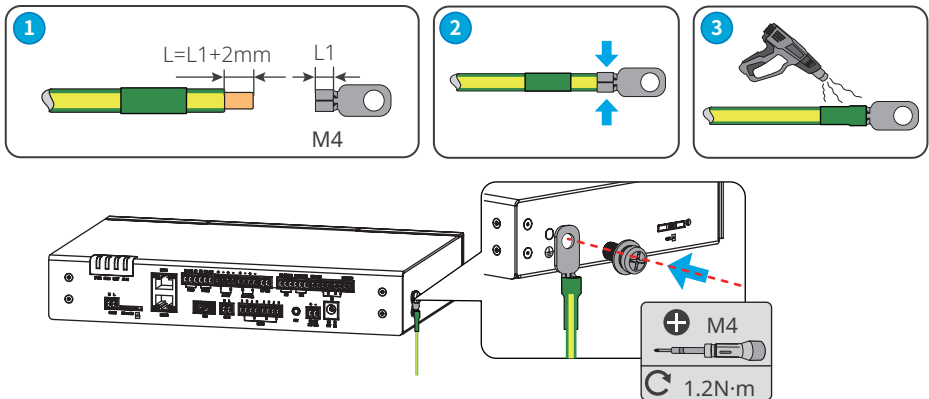

6.4 Connecting the PT Signal Cable

NOTICE

- The PT ports can be used to connect to two-wire or three-wire PT100/PT1000 temperature sensors.
- Short circuit B1 port and B2 port when connecting the EzLogger to a two-wire temp. sensor.

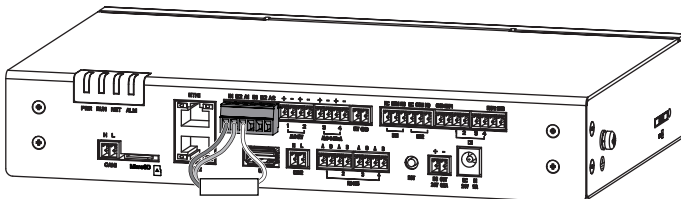

Three wire PT100/PT1000

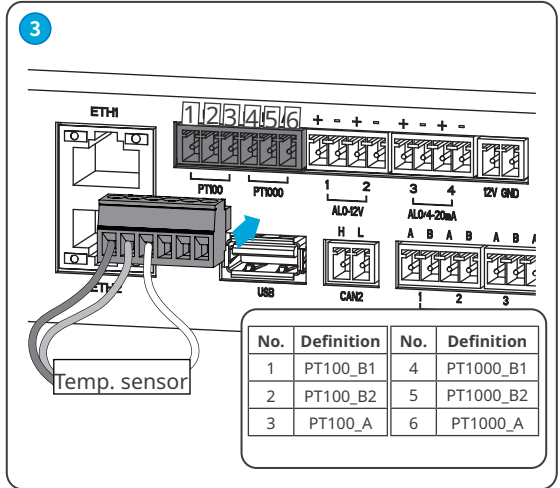
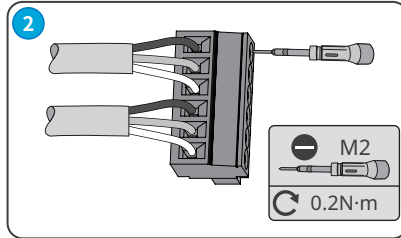
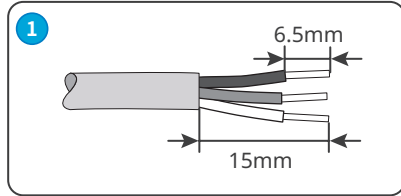

Two wire PT100/PT1000

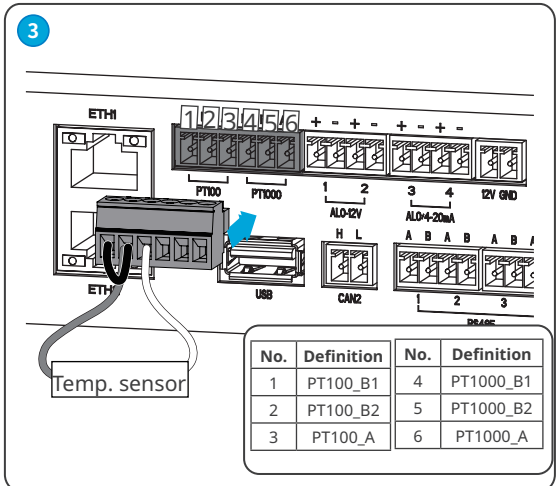
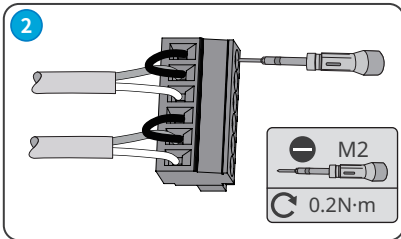
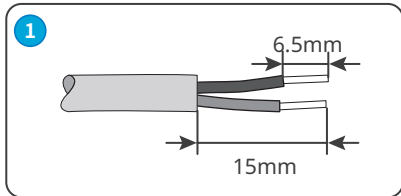

6.5 Connecting the AI Signal Cable

NOTICE

- The EzLogger provides AI ports, which can be used to receive voltage or current analog input signals.
- Connect the remote shutdown device to **AI1+** or **AI2+** port and **12V Output** port of the EzLogger to realize remote shutdown.

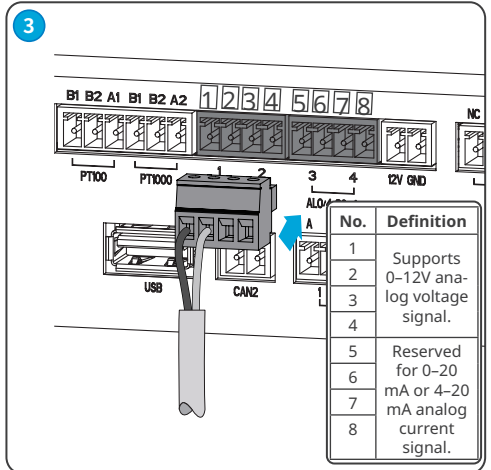
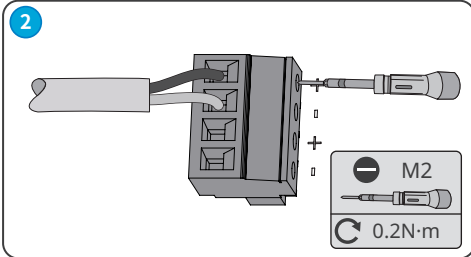
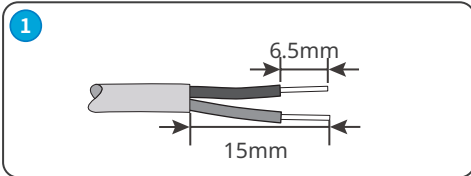
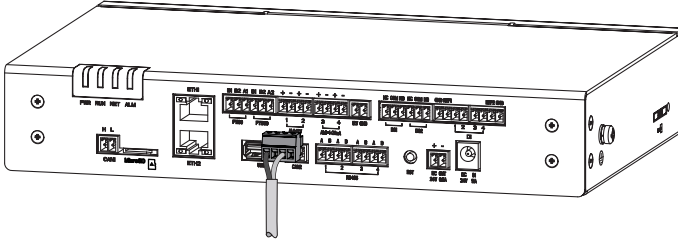

6.6 Connecting the 12V DC Output Cable

NOTICE

Only for remote shutdown.

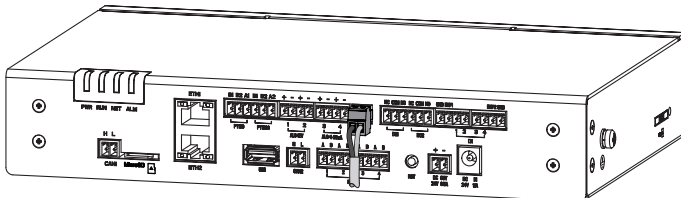

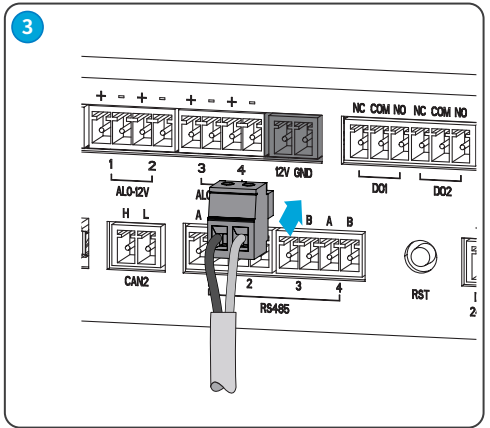
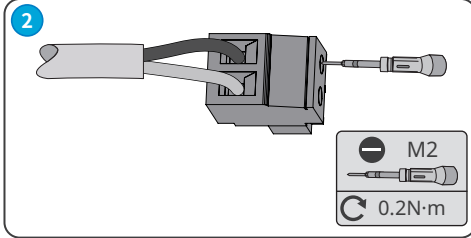
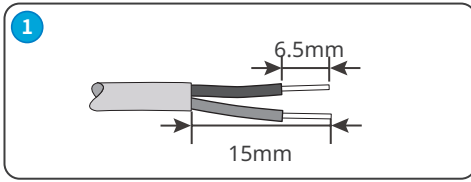

6.7 Connecting the DO Communication Cable

NOTICE

- The EzLogger can output passive dry contact signal.
- The DO port supports a maximum of 30V/1A signal voltage. The NC/COM means normally closed contact, and NO/COM means normally open contact.
- It is recommended to keep the signal transmission distance within 10 meters.

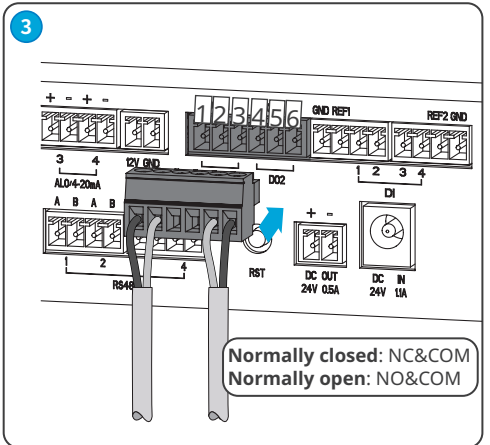
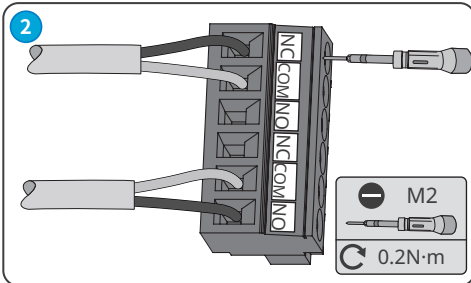
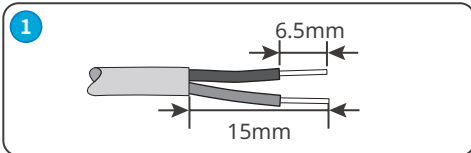
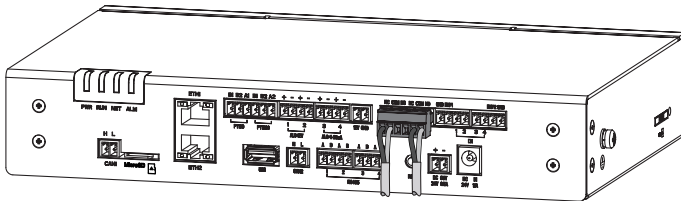

6.8 Connecting the DI Communication Cable

NOTICE

- The EzLogger offers Demand Response Enabling Device(DERD) signal control port, meeting DRED certification requirements in Australian and other regions.
- The EzLogger offers Ripple Control Receiver (RCR) signal control port, meeting requirements in German and other regions.
- The EzLogger offers Over Voltage Ground Relay(OVGR)/Reverse Power Relay(RPR) signal control port, meeting the requirements of different application scenarios in Japan and other regions.
- The EzLogger can receive passive dry contact signal or active wet contact signal. Supported voltage range of active contact: 0-12V, and 8-12V means high level.
- It is recommended to keep the signal transmission distance within 10 meters.

Passive dry contact

Function	Silkscreen	Definition	Definition
DI1	-	REF1	REF1
	DI	1	DI1
DI2	-	REF1	REF1
	DI	2	DI2
DI3	-	REF2	REF2
	DI	3	DI3
DI4	-	REF2	REF2
	DI	4	DI4

Active wet contact

Function	Silkscreen	Definition	Definition
DI1	-	GND	GND
	DI	1	DI1
DI2	-	GND	GND
	DI	2	DI2
DI3	-	GND	GND
	DI	3	DI3
DI4	-	GND	GND
	DI	4	DI4

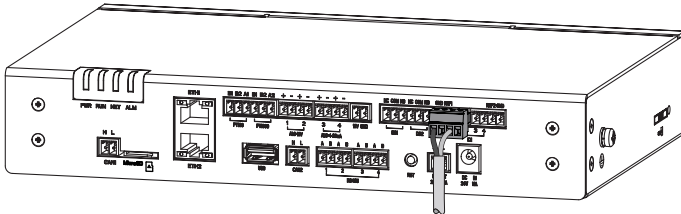

Active wet contact

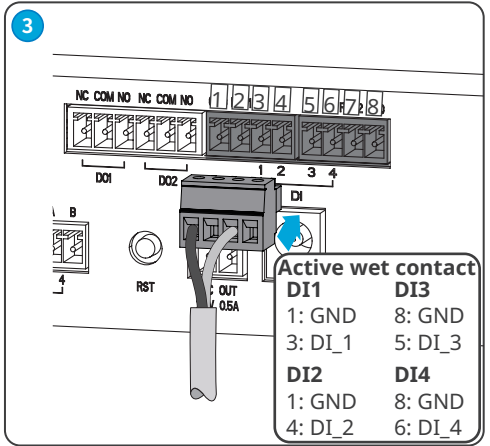
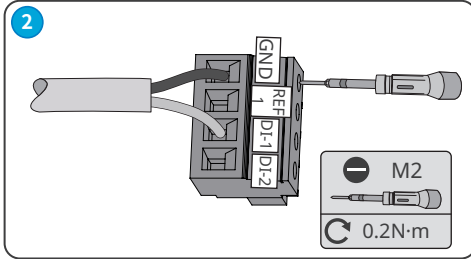
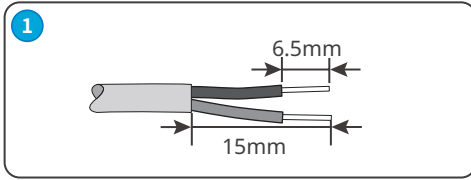

Passive dry contact

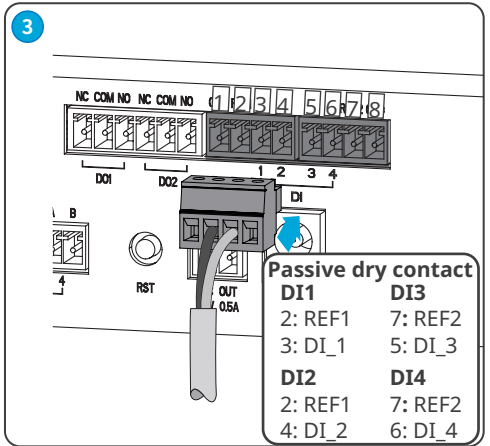
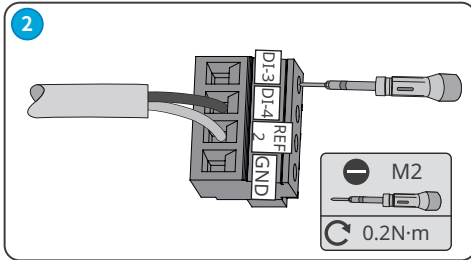
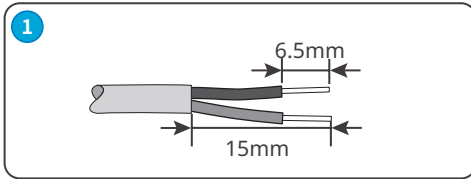

6.9 Connecting the RS485 Signal Cable

NOTICE

- The EzLogger offers RS485 communication ports for connecting RS485 communication devices, such as inverters, smart meters, or environmental monitoring instruments.
- The EzLogger offers DER_AVM signal control port, meeting requirements in Korea and other regions.
- Connect RS485A of the device to RS485A of the EzLogger, and RS485B to RS485B of the EzLogger.
- Ensure that the shielded layer of the shielded twisted pair cable is properly grounded.

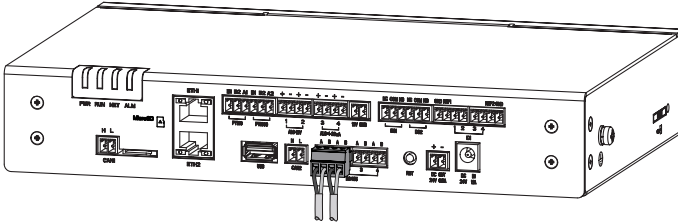

No.	Function	Silkscreen	Definition
1	Connect to RS485 communication devices, such as inverters, smart meters, environmental monitoring instruments.	RS485	1 A RS485_A1
2			1 B RS485_B1
3			2 A RS485_A2
4			2 B RS485_B2
5			3 A RS485_A3
6			3 B RS485_B3
7			4 A RS485_A4
8			4 B RS485_B4

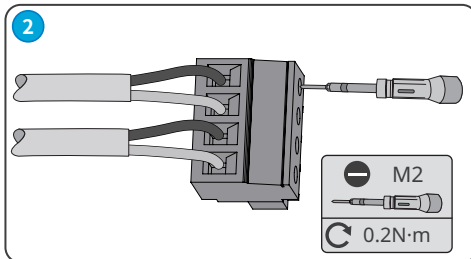
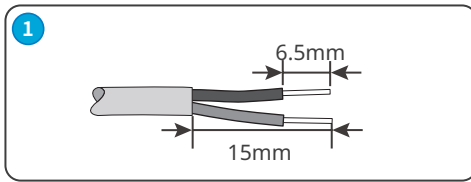

No.	Definition	No.	Definition
1	RS485_A1	5	RS485_A3
2	RS485_B1	6	RS485_B3
3	RS485_A2	7	RS485_A4
4	RS485_B2	8	RS485_B4

6.10 Connecting the Ethernet Cable

NOTICE

- Recommended cable specification: CAT 5E or higher outdoor shielded network cable and shielded RJ45 connector.
- ETH1 is designed for network communication. The default IP mode of EHT1 is dynamic IP mode, which allows access of router, switch, and so on.
- ETH2 is designed for network communication or embedded web connection. The default IP mode of EHT2 is dynamic IP mode, with a virtual IP: 172.18.0.12. The Ethernet cable is used for connecting a router or a Ethernet switch, or connecting a PC for embedded web configuration.
- Refer to section **8.4.1 Setting the Port Parameter** for more details about modifying IP parameters of ETH port.
- If the PC provides USB or Type-C port only, prepare a network port adapter to connect the EzLogger and the PC.

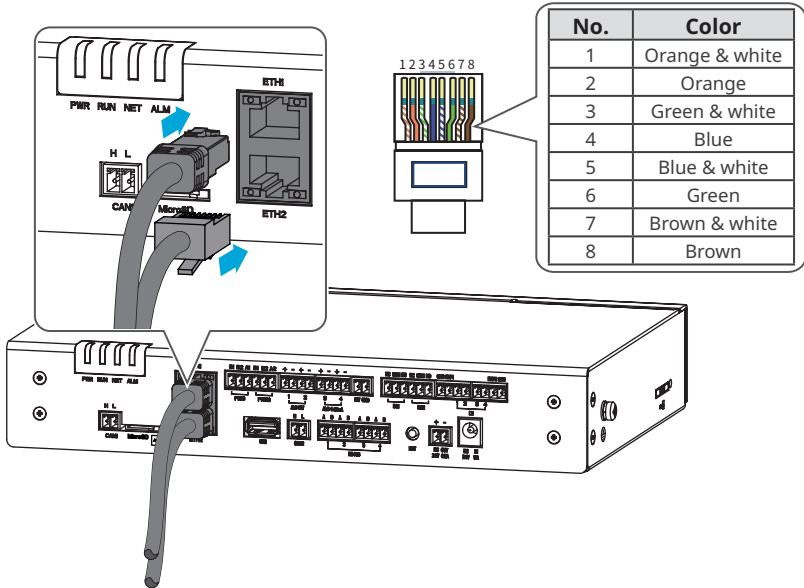

6.11 Connecting the 24V DC Output Cable

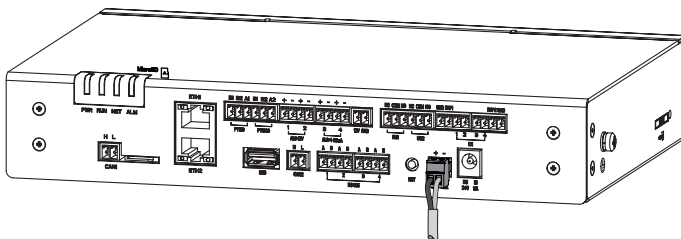

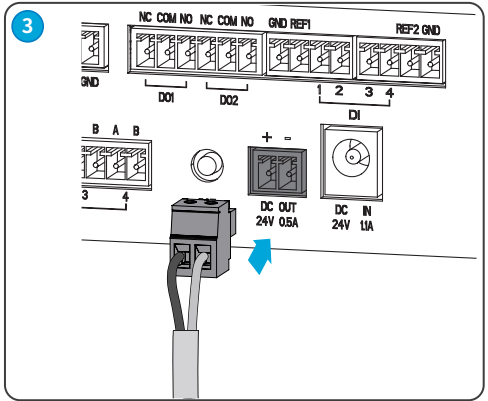
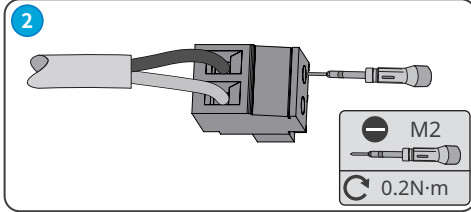
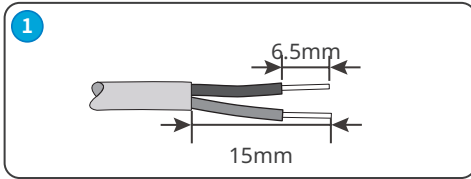

6.12 Connecting the Power Cable

NOTICE

- Connect the delivered power adapter to the DC input port to supply power to the EzLogger.
- Refer to actual appearance of the power adapter.
- Specification of the power adapter: Input: AC 100V~240V, 50Hz/60Hz; Output: DC 24V, 1.5A.

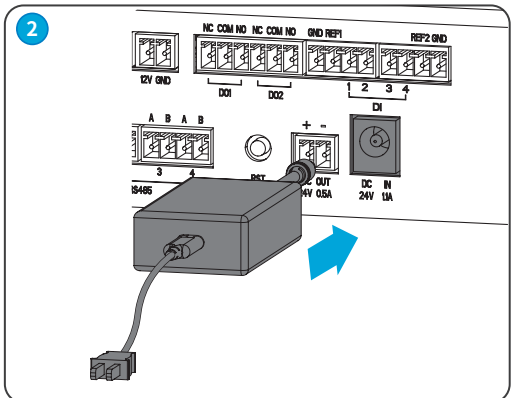
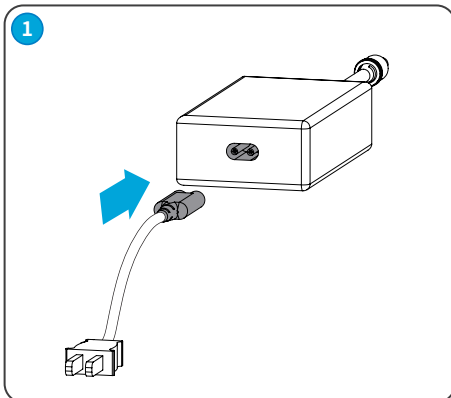
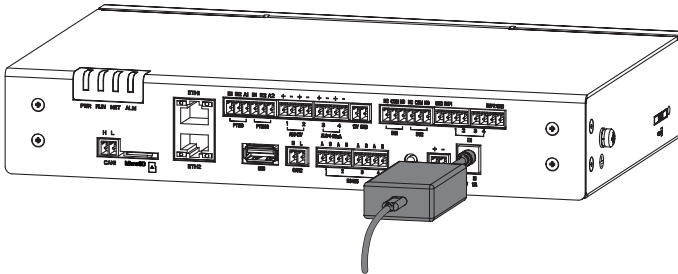

6.13 Installing SIM Card(optional)

NOTICE

- Insert the SIM card for 4G functions. 4G is available in some countries and regions. Contact local distributors for more details.
- The SIM card should be prepared by customers. Standard SIM card, size 25*15mm and capacity \geq 64KB, is recommended.
- Data for single inverter should be at least 200M/month. Data for multi inverters should be 200M+30M*n/month, n is the quantity of inverters..

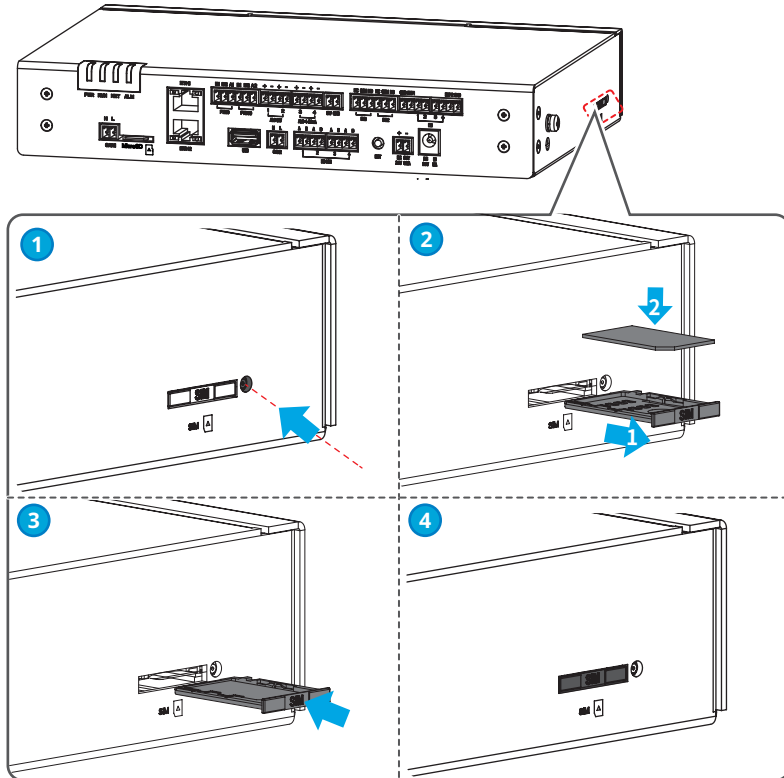

6.14 Installing the USB Flash Drive

NOTICE

- Install the USB flash drive into the USB port to upgrade the firmware of the EzLogger. Contact the after-sales service for upgrading package.
- Prepare a FAT30 USB flash drive by yourself. The capacity of it does not exceed 32G.

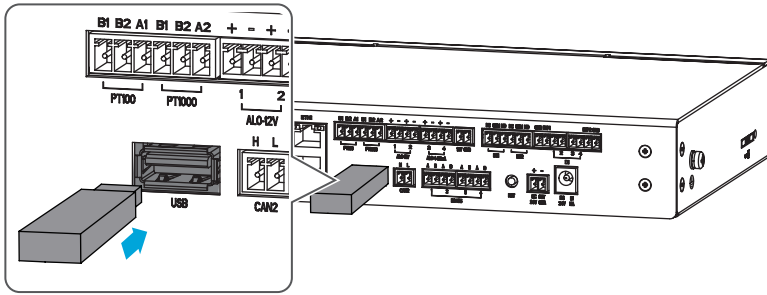

6.15 Installing the MicroSD Card

NOTICE

Install a MicroSD card to store the breakpoint data, so that the breakpoint data can be uploaded properly.

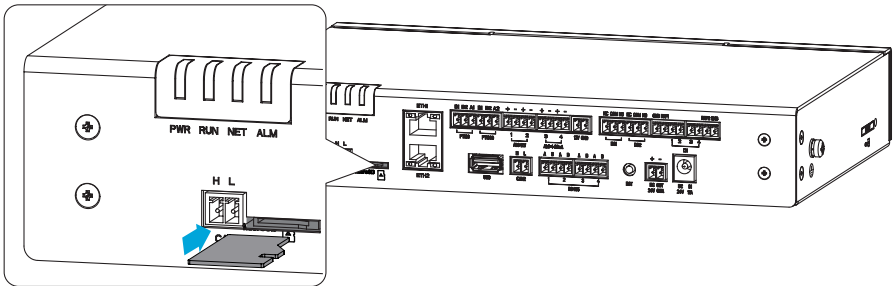

6.16 Installing the Antenna

NOTICE

Install the antenna properly and securely, otherwise the WiFi hotspot of the EzLogger may not be found.

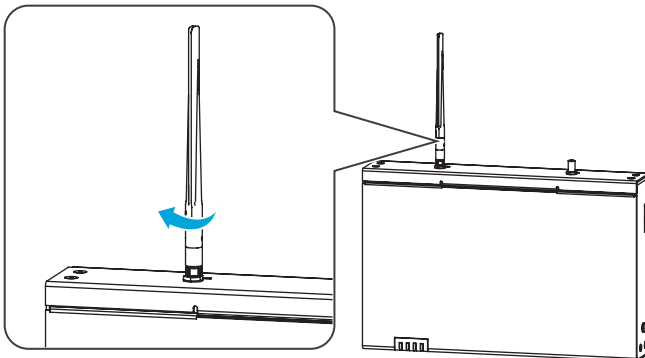

7 Equipment Commissioning

7.1 Check before Power On

No.	Check Item
1	The product is firmly installed at a clean place that is well-ventilated and easy-to-operate.
2	The power cable, net cable and communication cables are connected correctly and securely.
3	Cable ties are intact, routed properly and evenly.
4	The input signal status are correct and the input power parameters are within the operating scope of the equipment.

7.2 Power On

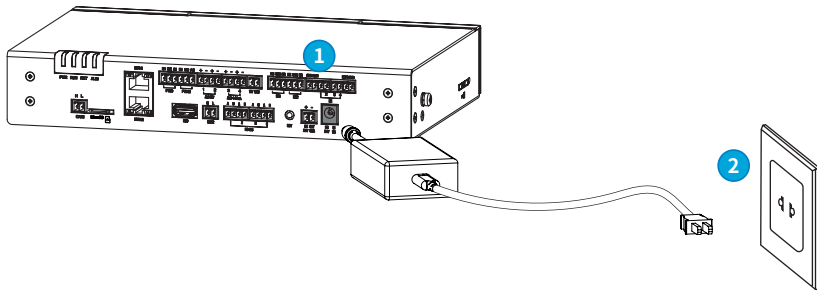











Step 1 Connect the power adapter to the EzLogger.

Step 2 Plug the power adapter to the AC socket and turn on the switch of the socket.

8 System Commissioning

8.1 Indicators and Buttons

LED Indicators

Indicator	Indicator status	Description
PWR		Steady green: The device is powered on.
		Green off: The device power supply is abnormal.
RUN		Steady green/Green off: The device fails to work.
		
		Slow blinking green: The device is working properly.
NET		Steady green: Communication between the device and the server is normal.
		Fast blinking green: Communication between the device and the router is normal, but communication between the device and the server fails.
		Slow blinking green: Communication between the device and the router fails.
ALM		Steady red: All the connected inverters are in fault status.
		Fast blinking red: the equipment is being upgraded.
		Red off: At least one inverter in the system is working properly.

Button

RST Button	Definition
Short press 1-3S	Restart the EzLogger.
Long press 6-20S	Restart the EzLogger and restores factory default network settings.

8.2 Commissioning via Web

8.2.1 Introduction to Web UI

Log into the embedded web to set parameters of the EzLogger, check running information and alarms to get the system status information in time.

! **WARNING**

- The web firmware version shown in this document is V3.4.21. The screenshots are for reference only. The actual display may differ.
- The name, range, and default value of the parameters are subject to change. The actual display prevails.
- When issuing reset, shutdown and upgrade commands to the inverter, the inverter may fail to connect to the utility grid, which will affect the power generation.
- The grid parameters, protection parameters, feature parameters and power regulation parameters of the inverter shall be set by professionals. Improper settings may cause the inverter fail to connect to the grid. Wrong settings of power regulation parameters may cause the inverter connected to the grid improperly, thus affecting the power generation.
- To prevent the generating capacity from being influenced by wrong settings, the grid scheduling parameters shall be set by professionals.

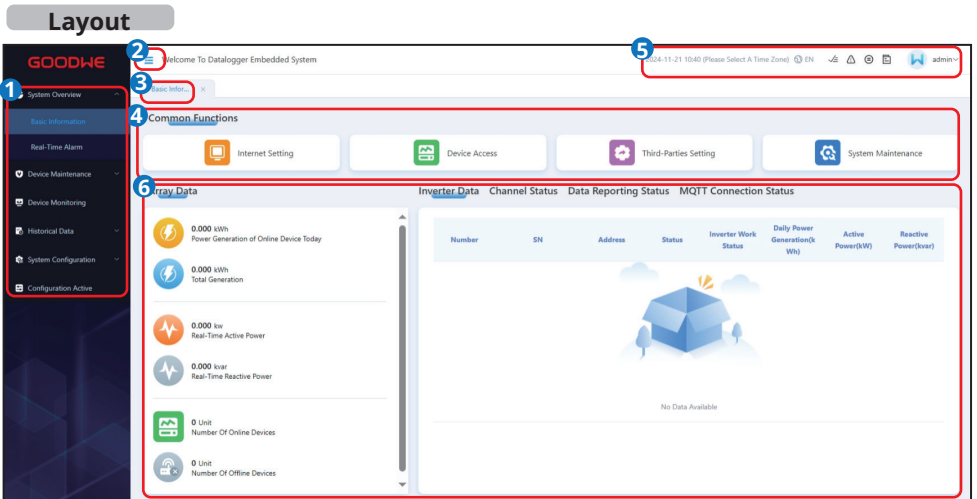

No.	Function	Description
1	Menu list	Area for the menus. Choose the main menu, then the second-level menu will be displayed. Under some main menus, there are no second-level menu.
2	Menu list button	Click to hide or show the menu list.
3	Tag list	Displays the opened menu tags.
4	Common functions	Displays the often used functions status for easy operation. The common functions can be set in the menu list.

No.	Function	Description
5	System status	<ul style="list-style-type: none"> • Displays the system time. • Switches the system language. • Configuration effective button. If there is a function that has been configured but has not yet taken effect, it will be indicated by a red dot. • Displays the alarming information. Click it to check the real-time alarms. • Displays the version of the product. • Check the start guide. • Displays the log in status. Click it to log out.
6	Power plant data	Displays the corresponding functional items or parameter setting under each menu.

Menu on the Interface

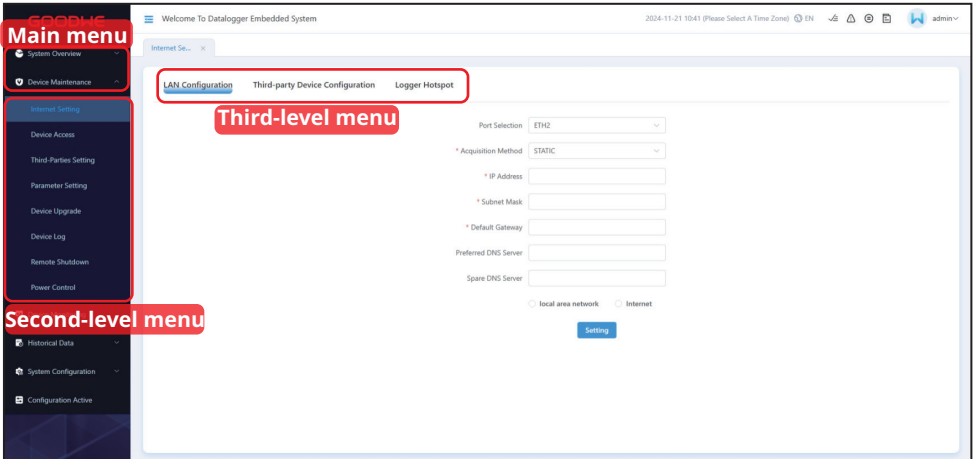

Main menu	Second-level menu	Third-level menu	Description
System Overview	Basic Information	-	<ul style="list-style-type: none"> • Common functions such as Internet Setting, Device Access, Third Parties Setting, System Maintenance. • Basic information such as Power Generation of Online Device Today, Total Generation, Real-Time Active Power, Real-Time Reactive Power, Number Of Online Devices, Number Of Offline Devices.
	Real-Time Alarm	-	Displays Total Number Of Alarms, Fault Alarm Name, Device SN, and Generation Time. Click Manually Refresh to display the latest alarms.

Main menu	Second-level menu	Third-level menu	Description
Device Maintenance	Internet Setting	LAN Configuration	Set parameters for LAN communication.
		4G Configuration	Set parameters for 4G communication.
		Third-Party Configuration	Set RS485 parameters. Support to connect with third party equipment over RS485. The baud rate of the RS485 includes 300, 1200, 2400, 9600, 19200.
		Logger Hotspot	Set the hotspot name and password of the EzLogger.
	Device Access	-	Add inverters, smart meters and other devices by automatic searching or manually adding.
	Third-Parties Setting	IEC104	Set IEC104 parameters.
		Modbus-TCP	Set Modbus-TCP parameters.
		IEEEE2030.5	Set IEEEE2030.5 parameters.
		Output Power Control	Set output power control parameters.
		Email	Set Email parameters.
		FTP/SFTP	Set FTP/SFTP parameters.
	Parameter Setting	Datalogger	Set log parameters and array parameters of the EzLogger.
		Inverter	Set grid parameter, protection parameters, characteristic parameters, and power adjustment parameters of the inverter.
		MV Station	Configure remote control settings.
		Meter	Set CT ratio, mode and other parameters of the smart meter.
	Device Upgrade	Data Logger	Upgrade firmware of the EzLogger.
		Inverter	Upgrade firmware of the inverter.
	Device Log	-	Check running log, operation log and maintenance log of the equipment.
	Remote Shutdown	OVGR&RPR	Set OVGR&RPR parameters.
		Remote Shutdown	Set remote shutdown parameters.
	Power Control	Power Limit	Set power limit parameters.
		DRED	Set DRED parameters.
		RCR	Set RCR parameters.
DER_AVM		Set DER_AVM parameters.	
Communication Error Handling		Set handle methods when the EzLogger communication exception occurs.	
Device Monitoring	-	Inverter	Check parameters of the inverter.
	-	Weather Station	Check the information of the weather station.
	-	Smart meter	Check the information of the smart meter.
	-	MV Station	Check the information of the MV station.
	-	IEC104	Check IEC104 parameters.

Main menu	Second-level menu	Third-level menu	Description
Historical Data	Historical Faults And Alarms	-	Check the historical faults and alarms.
System Configuration	System Maintenance	-	<ul style="list-style-type: none"> Reset Logger Restore Factory Settings Import All Configuration Files Export All Configuration Files
	System Time	-	Set the way to calibrate the time: by system or manually.
	Safety Setting	-	Set security parameters like password.
	Version	-	Checks the version of the EzLogger, like SN, Main Program Version, Firmware Version, Web Version, etc
Configuration Active	-	-	Click to save the parameters. Click the Configuration Active to save the settings after configuration adjustments.

8.2.2 Log In

NOTICE

- All the equipment in the system are installed properly and powered on.
- Contact the after-sales service for the initial login username and password.
- Before login, ensure that the equipment meets the following requirements:
 - Supports Windows 7 or above version.
 - Browser: Chrome 52, Firefox 58, or above version is recommended.
 - The computer's network port is connected to EzLogger's ETH port with a network cable.
- Remove the network cable after configuration.
- To ensure account security, the same account cannot log in to the Web and SolarGo App at the same time.

Log into the web using the default IP

Step 1 Connect a PC to the ETH2 port of the EzLogger using a network cable.

Step 2 Select **Network and Internet > Change Adapter** on your computer system. In the network connections dialogue box that appears, right-click and click Properties to configure the IP address of the computer and the EzLogger on the same network segment.

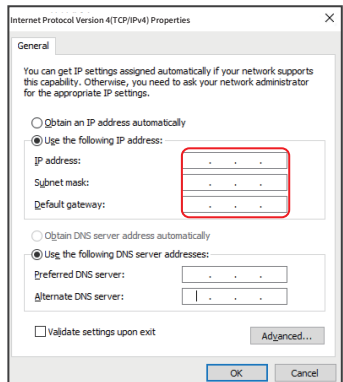

No.	IP Parameter	Default value of the EzLogger	Example value of the Computer
1	IP address	172.18.0.12	172.18.0.22
2	Subnet mask	255.255.255.0	255.255.255.0
3	Default gateway	172.18.0.1	172.18.0.1

Step 3 Enter **https://172.18.0.12:443** in the address bar of the web browser and press Enter.

Step 4 Select the language according to the actual demanding. Log in with the initial account and password.

NOTICE

Use the initial password to log in. Change the password as soon as possible and keep it in mind. To ensure the security of the account, it is recommended to change the password regularly.

Log into the web using a dynamic IP address

Step 1 Connect the PC and the EzLogger to a router at the same time.

Step 2 Check the IP address assigned to the EzLogger on the router management page.

Step 3 Enter **https://XX.XX.XX.XX:443** in the address bar of the web browser and press Enter. XX.XX.XX.XX refers to the IP address assigned by the router.

Log into the web using WiFi hotspot

Step 1 Connect to the default WiFi name of the EzLogger. Default WiFi: Log-***,*** means serial number of the EzLogger. Initial password: 12345678.

Step 2 Enter **https://172.18.0.12:443** in the address bar of the web browser and press Enter.

Step 3 Select the language according to the actual demanding. Log in with the initial account and password.

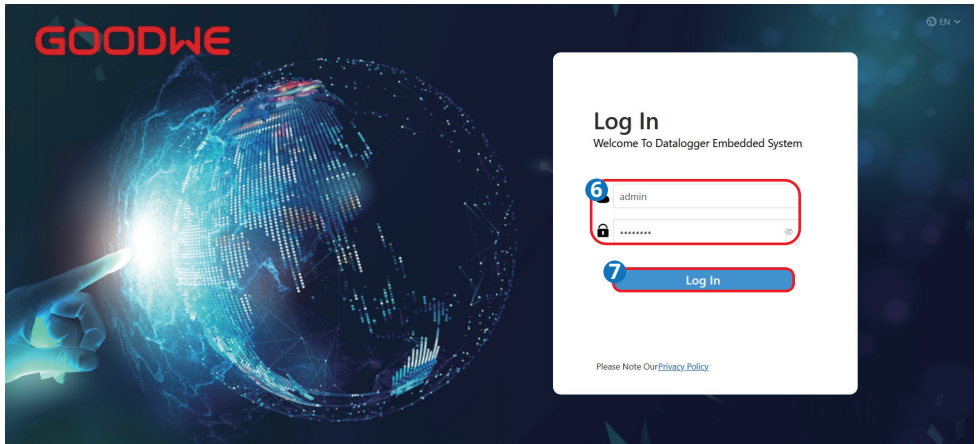
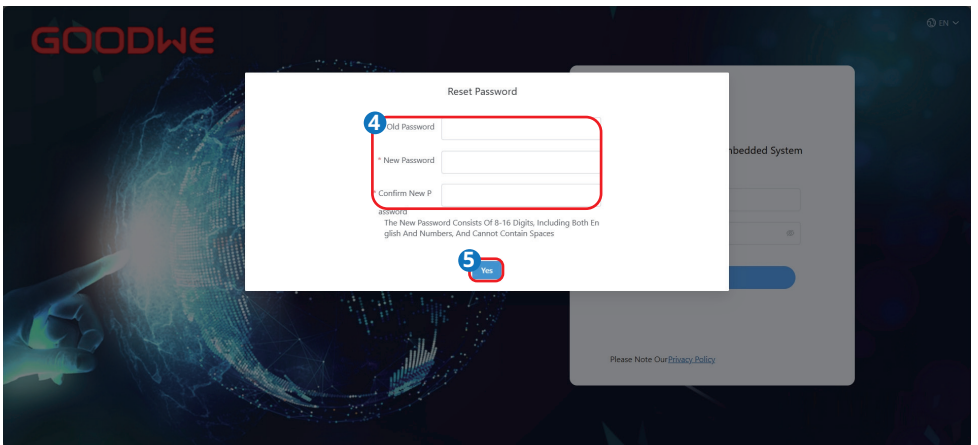
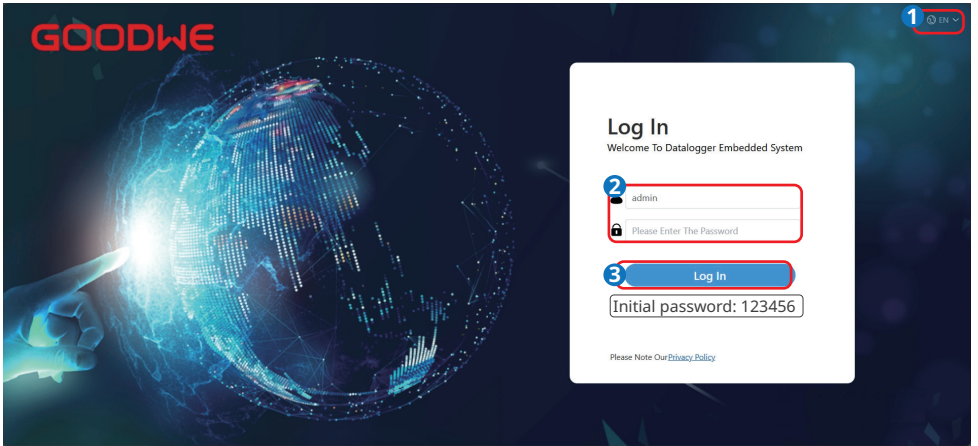

8.2.3 Setting the Network Parameters

NOTICE

The default network parameters will be displayed based on actual settings. Configure the parameters according to actual needs if necessary.

LAN Configuration

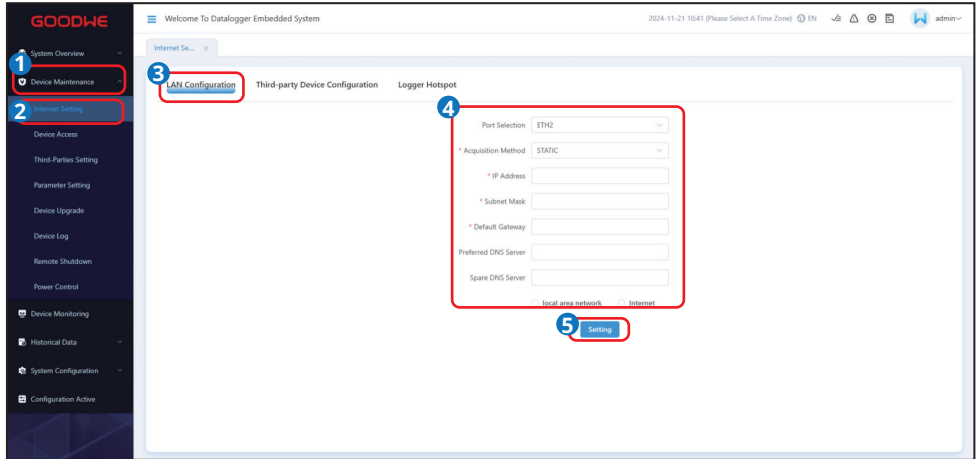

Parameter	Description
Port Selection	Select the connected network port of the EzLogger. Supported: ETH1 or ETH2.
Acquisition Method	<ul style="list-style-type: none"> Manually set the fixed network parameters based on actual situation when selecting STATIC mode. The IP address can be obtained automatically when selecting DHCP mode.
IP Address	Set the IP address of the EzLogger. Set the IP address on the same network segment as the router IP address, and based on the power plant planning. If the IP address is modified, log in with the new IP address.
Subnet Mask	Set the subnet mask of the EzLogger. Set the parameter based on the actual subnet mask of the router connected to the EzLogger.
Default Gateway	Set the default gateway of the EzLogger. Set the parameter based on the actual gateway of the router connected to the EzLogger.
Preferred DNS Server	Set the parameter as the IP address of the LAN's router when connecting to a public network, for example, connecting to GoodWe server, using a domain name for the server address.
Spare DNS Server	Ignore this parameter in common situations. When the preferred DNS server fails to resolve a domain name, use the alternate DNS server.
Local area network/Internet	Select Internet to connect to the server and transfer data to the cloud.

4G Configuration

NOTICE

- 4G is available in some countries and regions. Contact local distributors for more details.
- Disconnect the network cable between the EzLogger and the router after enabling 4G communication. Otherwise, the communication may fail.

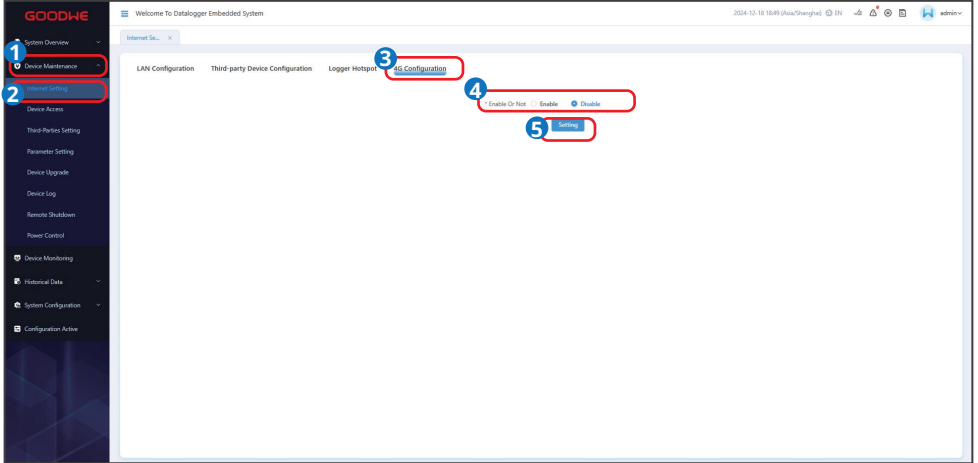

Parameter	Description
Enable Or Not	Enable or disable 4G function. Applicable only when the EzLogger accesses the system over the 4G network.
APN	Select the operator based on actual situation.

RS485 Third-Parties Configuration

NOTICE

Set the RS485 parameters when the EzLogger connects to a third-party device, such as a MV station or an environmental monitoring instrument.

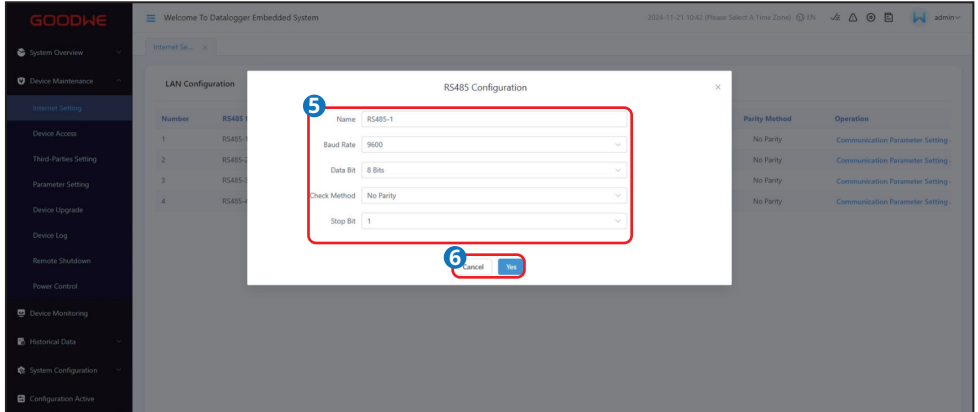
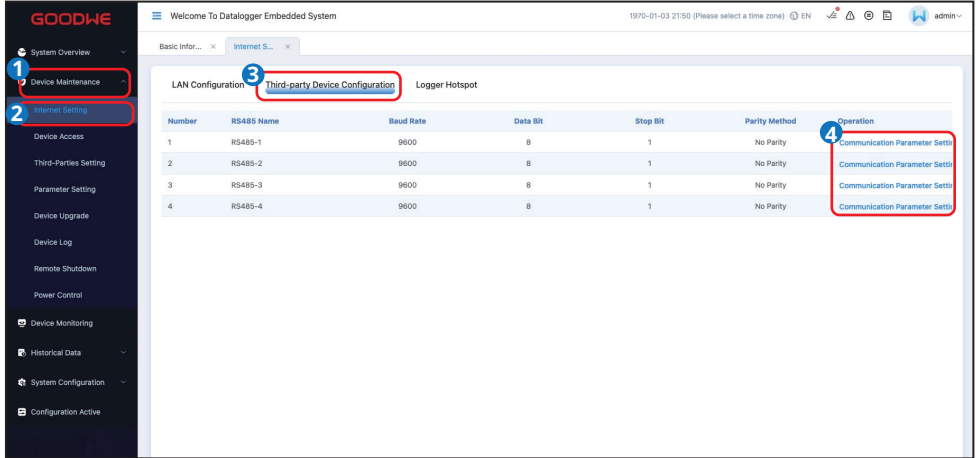

Parameter	Description
Name	Select the actual connected RS485 port of the device.
Baud Rate	Set according to the baud rate of the connected equipment. Supported baud rate: 300, 1200, 2400, 4800, 9600, 19200.
Data Bit	Supported value: 7 bits or 8 bits.
Parity Method	Set according to the parity check method of the connected equipment. Supported values: No Parity, Odd Parity, Even Parity, 1 Parity, or 0 Parity.
Stop Bit	Set according to the stop bit of the connected equipment. Supported values: 1, 1.5, and 2.

Logger Hotspot Configuration

NOTICE

- The EzLogger provides a WiFi hotspot signal for local configuration. After connecting to the WiFi hotspot signal, you can commission the device through the web page or SolarGo App.
- The SSID and password of the hotspot can be changed. After the change, log in to the web or App again using the new SSID and password.

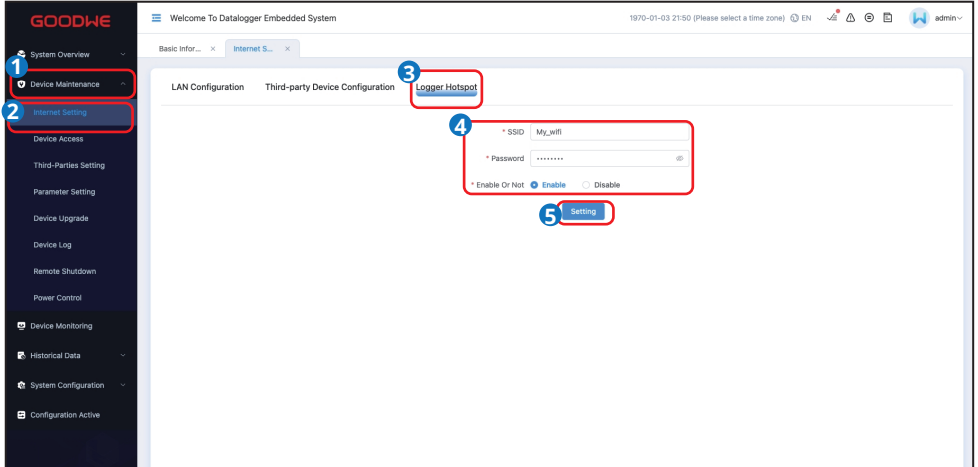

Parameter	Description
SSID	Hotspot signal name of the EzLogger. Default name: Log-***.
Password	Hotspot password of the EzLogger. Default password: 12345678.
Enable Or Not	Turn on or off the hotspot signal.

8.2.4 Adding Devices

8.2.4.1 Adding Devices via Automatic Search

NOTICE

Third party devices like smart meter cannot be found by Automatic Search, add the third party device via Manually Add.

Step 1 Follow the steps below to search for devices, click Stop Searching when the number of devices searched matches the actual number of devices. Check the RS485 wiring if any devices cannot be found.

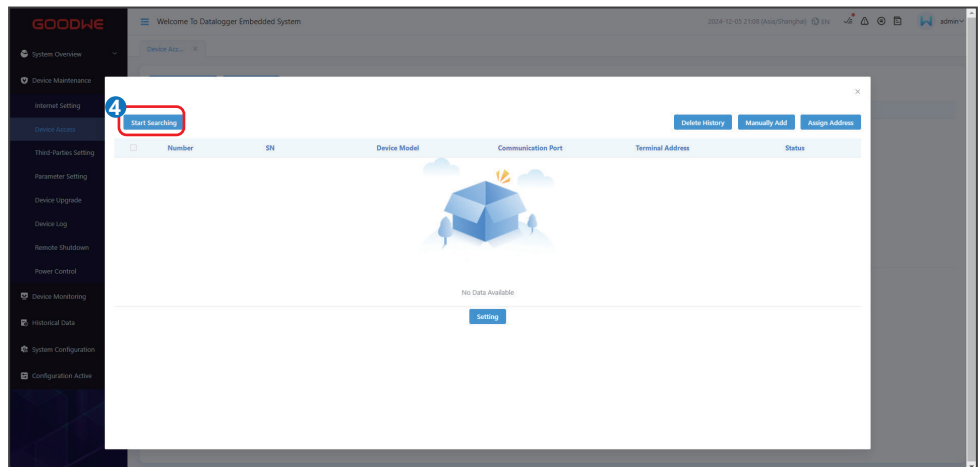
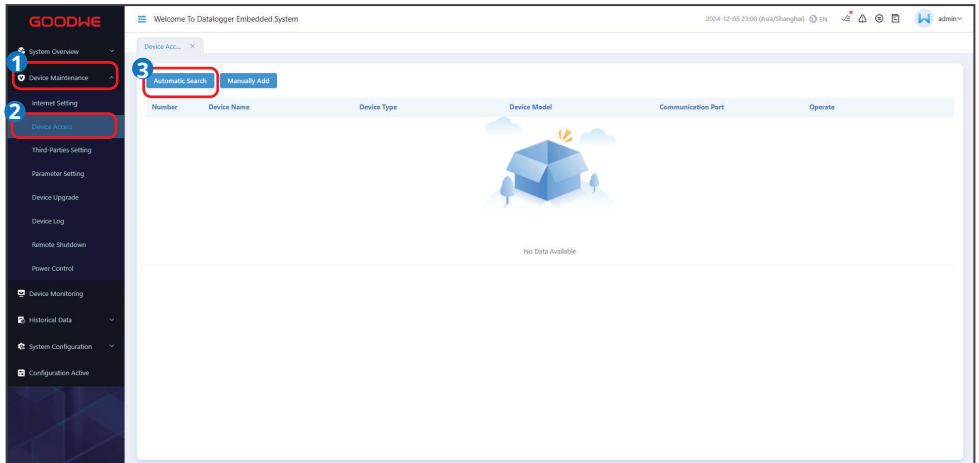

Step 2 Input the terminal address manually or click Assign Address based on actual need.

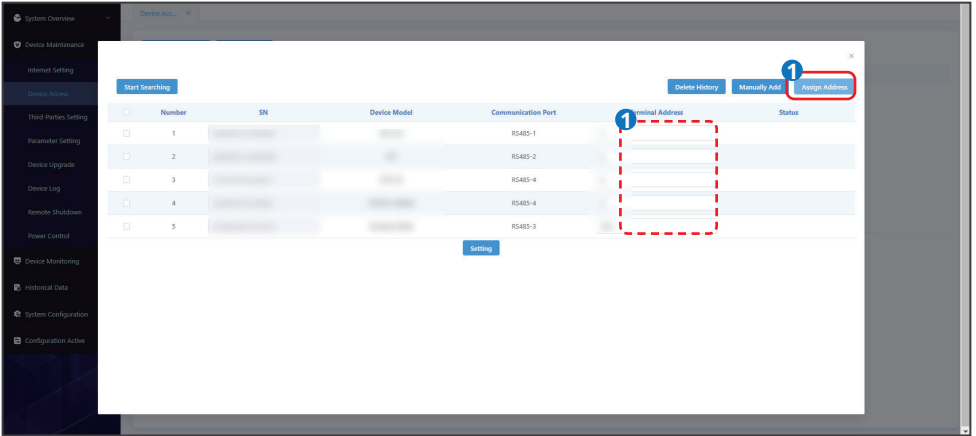

Step 3 (Optional) Add devices by filling in the device information manually if needed. Before adding a device, confirm the device model, device SN, and the communication port that the device is connected to.

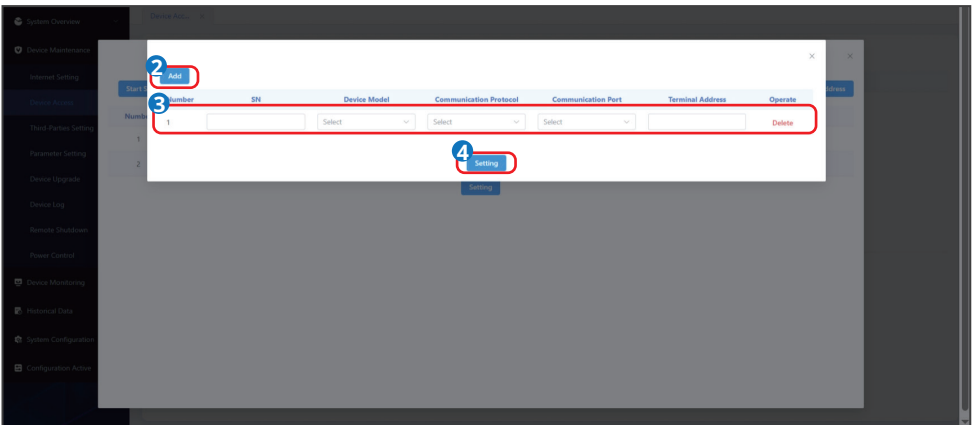
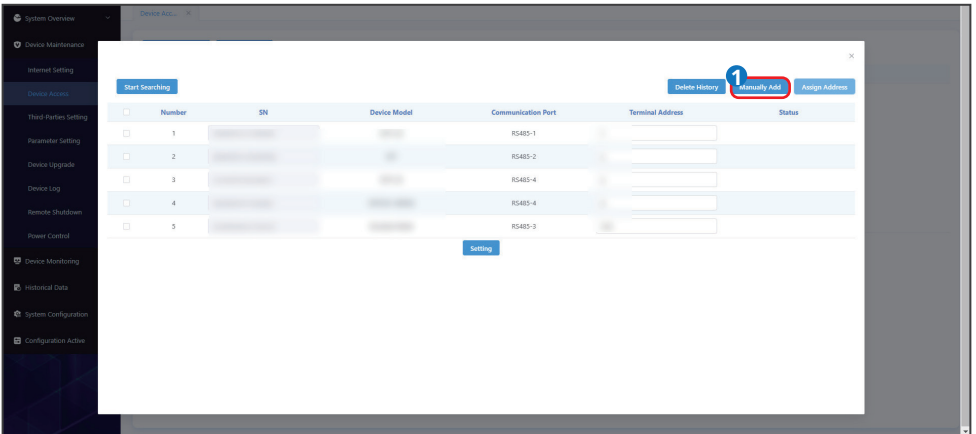

Step 4 Click Setting and go to Configuration Active as prompted.

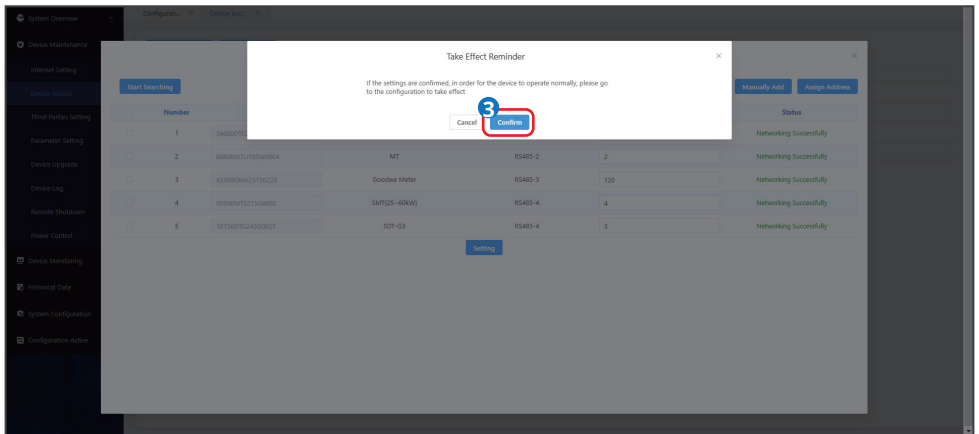
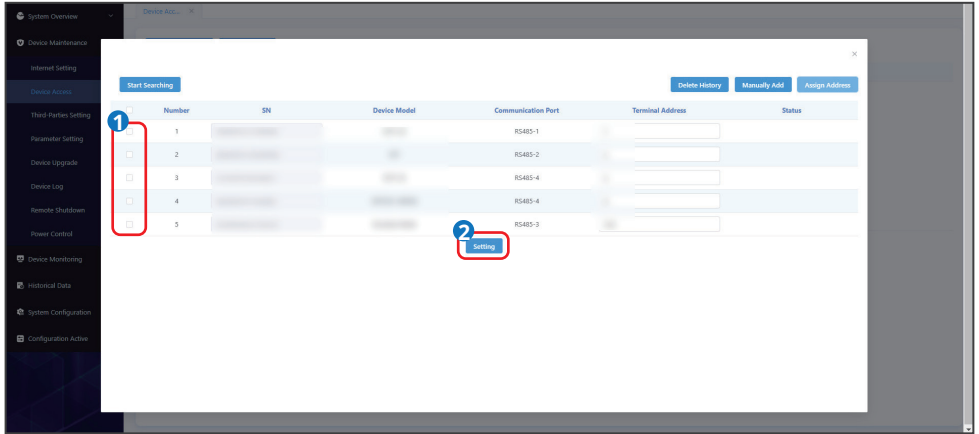

Step 5 After setting the system, log in again as prompted. Click Device Access and check whether the networking information is complete and correct.

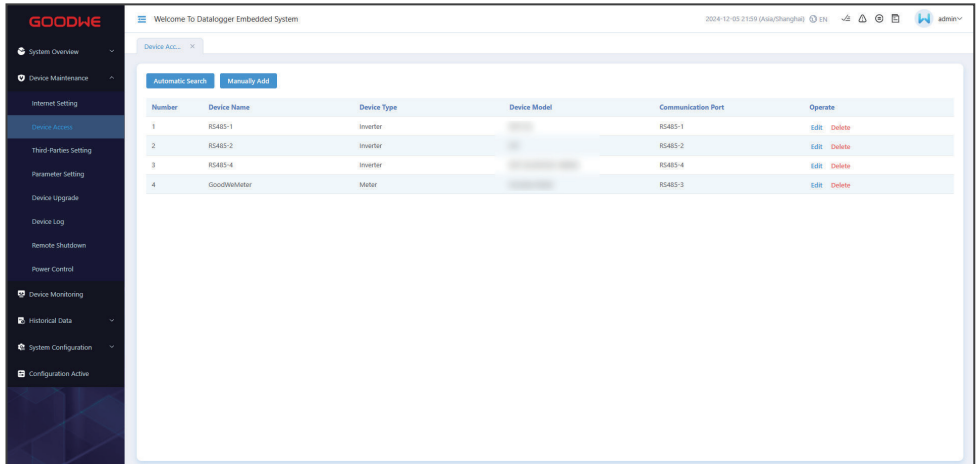

8.2.4.2 Adding Devices via Manually Add

NOTICE

Before adding a device, confirm the device model, device SN, and the communication port that the device is connected to. Otherwise, the adding may fail.

Step 1 Follow the steps below to add devices.

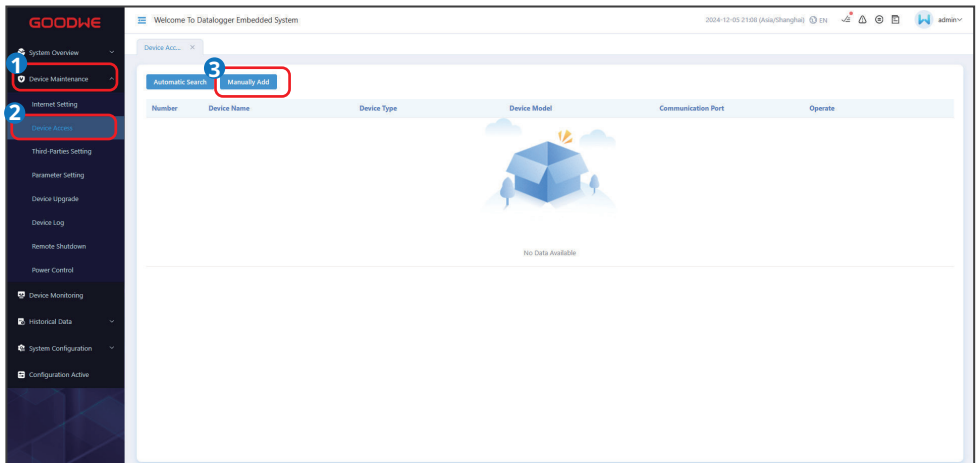

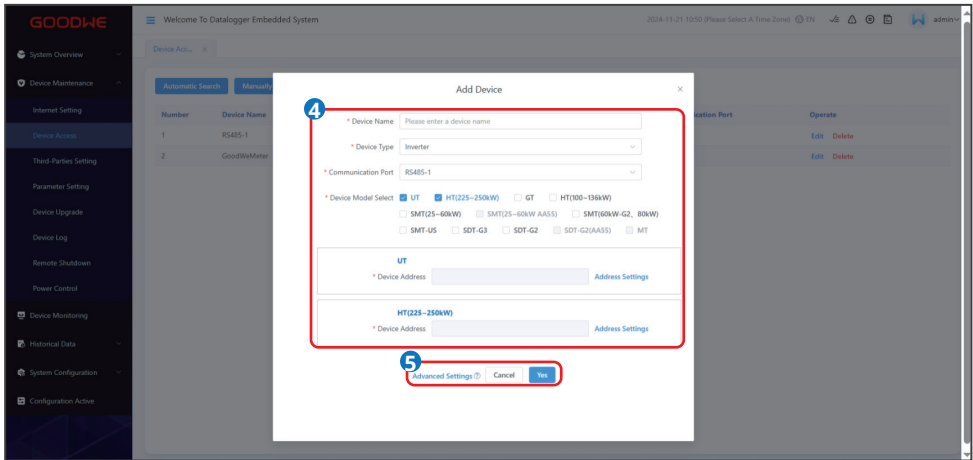

Add an inverter

Parameter	Description
Device Name	Define the device name based on actual needs.
Device Type	Select Inverter .
Communication Port	Select based on the actual port on the EzLogger which the inverter connected to. Supported port: RS485-1, RS485-2, RS485-3, RS485-4.
Select Device	Select the actual connected inverter model. Connect inverters of different models to one port is supported. UT and HT(225~250kW) can be connected to one RS485 communication port at the same time. GT, HT(100~136kW), SMT(25~60kW), SMT(80kW), SMT-US, SDT-G3 and SDT-G2 can be connected to one RS485 communication port at the same time.
Terminal Address	Device address. Set the parameter based on the actual power plant planning. Select Auto-Generate when there is no need to set the parameters based on the actual settings. Make sure that the terminal address is consistent with the communication address of the inverter on the SolarGo app.

Add a smart meter

Parameter	Description
Device Name	Define the device name based on actual needs.
Device Type	Select Smart Meter.
Communication Protocol	Set the parameter based on the communication protocol of the smart meter. Supported: Modbus-RTU.
Communication Port	Select the actual connected port on the EzLogger. Supported port: RS485-1, RS485-2, RS485-3, RS485-4.
Device Subtype	This option is displayed when the communication protocol is Modbus-RTU. Set this parameter based on the actual meter model. Supported: Goodwe Meter(GM330), UMG604PRO, Acrel-DTSD1352, Schneider-IEM3255, and Others.

Parameter	Description
Meter Purpose	<ul style="list-style-type: none"> Select based on the actual purpose. Supported: Grid Side Meter or Point Of Interconnection Meter Grid Side Meter: for power limiting, supports Goodwe Meter(GM330), UMG604PRO and Acrel-DTSD1352. Point Of Interconnection Meter: for metering, supports Schneider-IEM3255.
Terminal Address	Device address. Set the parameter based on the actual power plant planning. Select Auto Generate when there is no need to set the parameters based on the actual settings.
Access Point Table	Select the point table based on actual situation.

Add other devices

Parameter	Description
Device Name	Define the device name based on actual needs.
Device Type	Select Other Devices.
Communication Protocol	Select based on the communication protocol of the device. Support Modbus-RTU, Modbus-TCP and GW-XPB.
When the Communication Protocol is Modbus-RTU, set the following parameters based on actual situation:	
Communication Port	Select the actual connected port on the EzLogger. Supported port: RS485-1, RS485-2, RS485-3, RS485-4.
Device Subtype	Select the device type based on the actual situation. Supported: Weather Station, MV Station or Other.
MV Station Sub-Type	If the Device Subtype is MV Station, set the MV Station Sub-Type to General or Distributed.
Terminal Address	Device address. Set the parameter based on the actual power plant planning.
Protocol Type	Set the protocol type based on the actual situation.
Access Point Table	Import the access point table of the connected device.
IEC104 Forwarding	Select the forwarding table based on actual situation.
Modbus-TCP Forwarding	Select the forwarding table based on actual situation.
When the Communication Protocol is Modbus-TCP, set the following parameters based on actual situation:	
Communication Mode	Set the communication mode based on actual situation. Supported: UDP, TCPClient and TCPServer.
Local IP Address	Set the IP address of the net port of the EzLogger.
Local Port	Set the port number of the EzLogger. Default value: 502.
Remote IP Address	Set the IP address of the added device.
Remote Port	Set the port number of the added device. If the number is no fixed, set it to be 0.
Terminal Address	Device address. Set the parameter based on the actual power plant planning. Select Auto Generate when there is no need to set the parameters based on the actual settings.

Parameter	Description
When the Communication Protocol is GW-XPB, set the following parameters based on actual situation:	
Communication Port	Select the actual connected port on the EzLogger. Supported port: RS485-1, RS485-2, RS485-3, RS485-4.
Terminal Address	Device address. Set the parameter based on the actual power plant planning.

8.2.5 Setting EzLogger Parameters

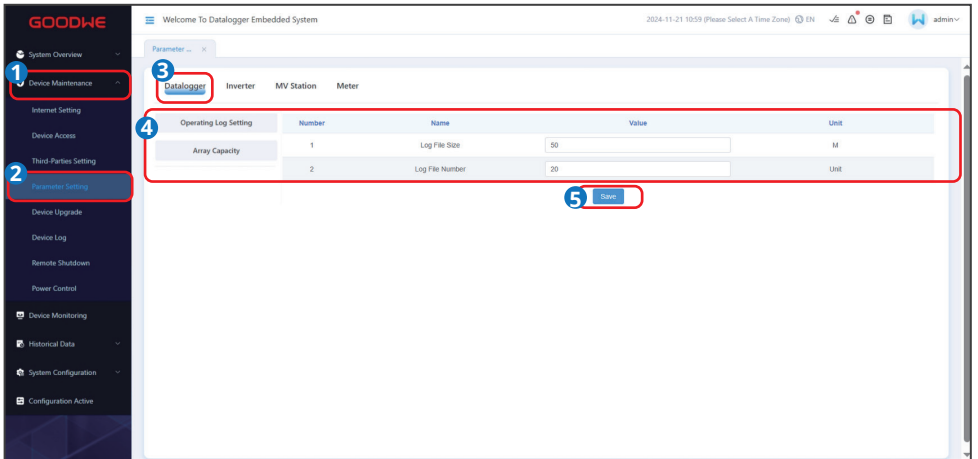

Parameter	Description
Operating Log Setting	
Log File Size	Set the size and quantity of log files to be stored according to the actual demanding.
Log File Number	
Array Capacity	
Array Capacity	Set according to the actual array capacity.

8.2.6 Setting Inverter Parameters

NOTICE

- The parameters to be set vary with the inverter type. The actual setting interface prevails.
- Supports selecting multiple inverters and parameterising the selected multiple inverters.
- Enter 0 or 1 to enable or disable a function. 0 indicates disable the function, and 1 indicates enable the function.

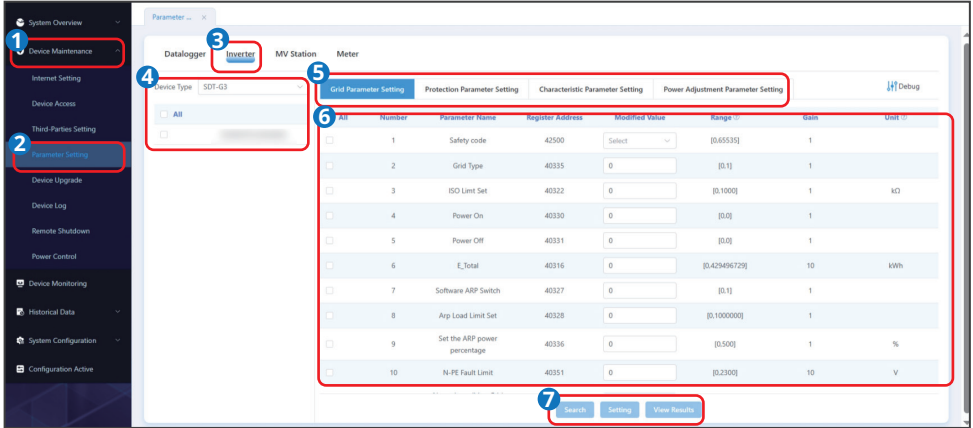

Grid Parameter Setting

Parameter	Description
Safety Code	Select based on the grid standards of the country/region where the inverter is located and its application scenario.
SPD Detection Switch	Enable or disable SPD detection function.
Power On (Allowing Grid-connection Self-test)	Issue power on instructions to allow grid connection self-test.
Shutdown (Not Allowing Grid-connection Self-test)	Issue power off instructions to stop grid connection self-test.
Output Method	<ul style="list-style-type: none"> • Set whether the inverter's output includes the neutral (N) cable based on its application scenario. • 0: three-phase four wire (3W/PE); 1: three phase five wire (3W/N/PE).
Shadow Scan Function Switch 1	PV strings may exist significant shading in PV systems where the inverter is applied. Enabling this feature, allows the inverter to perform a global MPPT scan at regular intervals to find the maximum power point.
Active Power Fixed Value Derating	Adjust the active power output of the inverter by fixed value.
Active Power Percentage Derating (0.1%)	Adjust the active power output of the inverter by percentage of rated power.
Reactive Power Compensation (PF)	Set the power factor of the inverter.

Parameter	Description
Reactive Power Compensation (Q/S)	Set the reactive power output from the inverter.
Reactive Power Compensation Fixed Value	Adjust the reactive power output of the inverter by fixed value.
Night Reactive Power Function Switch	Enable or disable night reactive power function. In some specific application scenarios, the power grid company requires that the inverter can perform reactive power compensation at night to ensure that the power factor of the local power grid meets requirements.
Night Reactive Power Parameters Taking Effect	Enable this function, the inverter outputs reactive power based on Fixed Value of Night Reactive Power Scheduling . Otherwise, the inverter executes the remote scheduling command.
Percentage of Night Reactive Power Scheduling (0.1%)	Schedule the reactive power by percentage during night reactive scheduling period.
Fixed Value of Night Reactive Power Scheduling	Schedule the reactive power by fixed value during night reactive scheduling period.

Protection Parameter Setting

Parameter	Description
Overvoltage Trigger n-order Value (0.1%)	Set the Level n overvoltage protection threshold, n=1, 2, 3, 4.
Overvoltage Trigger n-order Trip Time	Set the Level n overvoltage protection duration, n=1, 2, 3, 4.
Undervoltage Trigger n-order Value (0.1%)	Set the Level n undervoltage protection threshold, n=1, 2, 3, 4.
Undervoltage Trigger n-order Trip Time	Set the Level n undervoltage protection duration, n=1, 2, 3, 4.
10min Overvoltage Trigger Value (0.1%)	Set the 10-min overvoltage protection threshold.
10min Overvoltage Trip Time	Set the 10-min overvoltage protection duration.
Overfrequency Trigger n-order Value	Set the Level n overfrequency protection threshold, n=1, 2, 3, 4.
Overfrequency Trigger n-order Trip Time	Set the Level n overfrequency protection duration, n=1, 2, 3, 4.
Underfrequency Trigger n-order Value	Set the Level n underfrequency protection threshold, n=1, 2, 3, 4.
Underfrequency Trigger n-order Trip Time	Set the Level n underfrequency protection duration, n=1, 2, 3, 4.
Start-up Grid Connection Voltage Upper Limit	The inverter cannot connect to the grid if it is powered on for the first connection and the grid voltage is higher than the Start-up Grid Connection Voltage Upper Limit .
Start-up Grid Connection Voltage Lower Limit	The inverter cannot connect to the grid if it is powered on for the first connection and the grid voltage is lower than the Start-up Grid Connection Voltage Lower Limit .

Parameter	Description
Start-up Grid Connection Frequency Upper Limit	The inverter cannot connect to the grid if it is powered on for the first connection and the grid frequency is higher than the Start-up Grid Connection Frequency Upper Limit .
Start-up Grid Connection Frequency Lower Limit	The inverter cannot connect to the grid if it is powered on for the first connection and the grid frequency is lower than the Start-up Grid Connection Frequency Lower Limit .
Start-up Grid Connection Waiting Time	The waiting time for connecting the inverter to the grid when the inverter is powered on for the first connection.
Start-up Grid Connection Power Loading Rate (0.1%Pn/min)	Set the percentage of incremental output power per minute when the inverter is powered on for the first connection.
Reconnection Voltage Upper Limit	In some countries/regions, when the inverter is shut down due to a fault protection, it is not allowed to reconnect to the grid if the grid voltage is higher than the set value of the Reconnection Voltage Upper Limit .
Reconnection Voltage Lower Limit	In some countries/regions, when the inverter is shut down due to a fault protection, it is not allowed to reconnect to the grid if the grid voltage is lower than the set value of the Reconnection Voltage Lower Limit .
Reconnection Frequency Upper Limit	In some countries/regions, when the inverter is shut down due to a fault protection, it is not allowed to reconnect to the grid if the grid frequency is higher than the set value of the Reconnection Frequency Upper Limit .
Reconnection Frequency Lower Limit	In some countries/regions, when the inverter is shut down due to a fault protection, it is not allowed to reconnect to the grid if the grid frequency is lower than the set value of the Reconnection Frequency Lower Limit .
Reconnection Waiting Time	Set the waiting time for the inverter to restart after a grid failure is restored.
Reconnection Power Loading Rate (0.1%Pn/min)	Set the percentage of incremental output power per minute when the inverter is not powered on for the first connection. For example, setting Reconnection Power Loading Rate to 10 means the reconnection slope is 10%Prated/min.
LVRT Enable	Low voltage ride-through (LVRT) refers to the situation, when the grid experiences a short-term low voltage abnormality, the inverter cannot immediately disconnect from the grid and has to work for a period of time. Enable this function, the inverter's LVRT is being activated.
LVRT Depth n	The ratio of the ride through voltage to the rated voltage at a feature point during LVRT, n= 1, 2, 3, 4, 5, 6, 7.
Hold Time n	The ride through time at a feature point during LVRT, n= 1, 2, 3, 4, 5, 6, 7.
Judgment Threshold of Entering LVRT	Set the threshold for triggering LVRT. The threshold settings should meet the local grid standard.
Judgment Threshold of Exiting LVRT	Set the threshold for exiting LVRT. The threshold settings should meet the local grid standard.

Parameter	Description
LVRT Positive Sequence Reactive Power K Value	During LVRT, the inverter needs to generate positive sequence reactive power to support the grid. This parameter is used to set the positive-sequence reactive power generated by the inverter.
LVRT Zero Current Mode Enable	The standards of some countries/regions require that the output current during LVRT should be limited. Enable this function, the output current is less than 10% of the rated current during LVRT.
Threshold of Entering Voltage	After enabling LVRT Zero Current Mode Enable , the zero current mode starts if the power grid voltage is less than Threshold of Entering Voltage during LVRT.
HVRT Enable	High voltage ride-through (HVRT) refers to the situation, when the grid experiences a short-term high voltage abnormality, the inverter cannot immediately disconnect from the grid and has to work for a period of time. Enable this function, the inverter's HVRT is being activated.
HVRT Depth n	The ratio of the ride through voltage to the rated voltage at a feature point during HVRT, n= 1, 2, 3, 4, 5, 6, 7.
Hold Time n	The ride through time at a feature point during HVRT, n= 1, 2, 3, 4, 5, 6, 7.
Judgment Threshold of Entering HVRT	Set the threshold for triggering HVRT. The threshold settings should meet the local grid standard.
Judgment Threshold of Exiting HVRT	Set the threshold for exiting HVRT. The threshold settings should meet the local grid standard.
HVRT Positive Sequence Reactive Power K Value	During HVRT, the inverter needs to generate positive sequence reactive power to support the grid. This parameter is used to set the positive-sequence reactive power generated by the inverter.
HVRT Zero Current Mode Enable	The standards of some countries/regions require that the output current during HVRT should be limited. Enable this function to set the output current less than 10% of the rated current during HVRT.
Threshold of Entering Voltage	After enabling HVRT Zero Current Mode Enable , the zero current mode starts if the power grid voltage is higher than Threshold of Entering Voltage during HVRT.
Current Sharing Mode	<ul style="list-style-type: none"> Set the sharing mode of reactive current and active current. 0: reactive power priority; 1: active power priority; 2: constant current mode.
Active Power Recovery Mode After Riding Through	<ul style="list-style-type: none"> Active current recovery mode during ride-through recovery, supported mode: slope recovery, first-order LPF recovery, and no requirement. 0: disable; 1: slope response; 2: time constant; 3: respond time
Active Power Recovery Rate After Riding Through	The rate at which the active current recovers during the ride through recovery process.
Active Power Recovery First-order LPF After Riding Through	The active current recovers at the characteristic of first order LPF after the ride through recovery.

Parameter	Description
Reactive Power Recovery Mode After Riding Through	<ul style="list-style-type: none"> Reactive current recovery mode during ride-through recovery, supported mode: slope recovery, first-order LPF recovery, and no requirement. 0: disable; 1: slope response; 2: time constant; 3: respond time
Reactive Power Recovery Rate After Riding Through	The reactive current recovers at the slope after the ride through recovery.
Reactive Power Recovery First-order LPF After Riding Through	The reactive current recovers at the characteristic of first order LPF after the ride through recovery.
Frequency Riding Through Enable	After enabling Frequency Riding Through Enable, the inverter continues to generate power during required time even the grid frequency is abnormal.
n-order Under Frequency Riding Through Point_UFn	Set the level n underfrequency protection threshold value, n=first, second, third.
n-order Under Frequency Riding Through Time_UTn	Set the level n underfrequency protection tripping time, n=first, second, third.
n-order Over Frequency Riding Through Point_OFn	Set the level n overfrequency protection threshold value, n=first, second, third.
n-order Over Frequency Riding Through Time_OTn	Set the level n overfrequency protection tripping time, n=first, second, third

Characteristic Parameter Setting

Parameter	Description
EU Remote Shutdown Enable	Enable or disable remote shutdown function.
Anti-PID Function Switch	Enable or disable anti-PID.
PID Recovery Function Switch	Enable or disable PID recovery.
Power Limit Switch	Enable or disable power limit.
Back Flow Power Percentage Setting	Set the back flow power by percentage.
Three-phase Power Limit Method Selection	<ul style="list-style-type: none"> Set the power limit mode. 0: the total power of the three phases cannot exceed the power limit. 1: power of any phase cannot exceed the power limit.
External Meter CT Ratio	Set the CT ratio of the smart meter.

Parameter	Description
ISO Threshold Setting	To protect the equipment, the inverter performs an insulation impedance check on the input side during self-check at startup. If the measured value is lower than the set value, the inverter will not connect to the grid.
NPE Overvoltage Detection Switch	Enable or disable N-PE overvoltage detection.
N-PE Error Threshold	Set the N-PE overvoltage alarm threshold.
Active Power Scheduling Response Method	<ul style="list-style-type: none"> Set the active power scheduling response method. Supported method: gradient control or PT-1 behavior. 0: disable; 1: gradient control; 2: PT-1 behavior tau; 3: PT-1 behavior respond time.
Gradient of Active Power	Set the active power change slope.
Active Power Scheduling LPF Time	Set the low pass filtering time for active power scheduling.
Reactive Scheduling Response Method	<ul style="list-style-type: none"> Set the reactive power scheduling response method. Supported method: gradient control or PT-1 behavior. 0: disable; 1: gradient control; 2: PT-1 behavior tau; 3: PT-1 behavior respond time.
Gradient of Reactive Power	Reactive Power Scheduling LPF Time
Set the low pass filtering time for reactive power scheduling	Set the low pass filtering time for reactive power scheduling.

Power Adjustment Parameter Setting

Parameter	Description
Power Baseline of Over Frequency Derating	The active power of the device will be derated according to a certain slope when the grid frequency exceeds overfrequency derating limit.
Under Frequency Loading Reference Mode	The active power of the device will be derated according to a certain slope when the grid frequency is lower than underfrequency derating limit.
Underfrequency Power Slope	The inverter output active power will change when the utility grid frequency is lower than the underfrequency limit. Indicates the slope when the inverter output power decreases.
PU Curve Enable	Enable or disable PU curve.
Vn Voltage Value (0.1%)	The percentage of actual voltage to the rated voltage at Vn point, n=1, 2, 3, 4.
Vn Active Power Value (0.1%)	The percentage of the output active power to the apparent power at Vn point, n=1, 2, 3, 4.

Parameter	Description
PU Curve Output Response Mode	The output response mode of the PU curve. Supported mode: gradient control or PT-1 behavior.
PU Curve Output Power Changing Rate	The power change slope when the PU Curve Output Response Mode is gradient control.
PU Curve Response Time Parameter	The response time when the PU Curve Output Response Mode is PT-1 behavior.
QU Curve Enable	Enable or disable PU Curve.
Vn Voltage Value (0.1%)	The percentage of actual voltage to the rated voltage at Vn point, n=1, 2, 3, 4.
Vn Active Power Value (0.1%)	The percentage of the reactive output power to the apparent power at Vn point, n=1, 2, 3, 4.
QU Curve Response Time Parameter	The response time when the QU curve output response Mode is PT-1 behavior.
Enter Curve Power (0.1%)	When the inverter output reactive power to the rated power ratio is between the Enter Curve Power and Exit Curve Power , the ratio meets QU curve requirements.
Exit Curve Power (0.1%)	
cosφ(P) Curve Enable Bit	Enable or disable cosφ(P) curve.
Point n Power (0.1%)	The percentage of the inverter output active power to the rated power at point A/B/C/ D/E.
point n cosφ Value (pf,0.001)	The power factor at point A/B/C/ D/E.
cosφ(P) Curve Response Time	The response time when the cosφ(P) curve response Mode is PT-1 behavior.
Enter Curve Voltage (0.1%)	When the grid voltage is between Enter Curve Voltage and Exit Curve Voltage, the voltage meets Cosφ curve requirements.
Exit Curve Voltage (0.1%)	When the grid voltage is between Enter Curve Voltage and Exit Curve Voltage, the voltage meets Cosφ curve requirements.
QP Curve Post Enable	Enable or disable QP curve.
QP Curve Pn	The percentage of the output active power to the rated power at Pn point, n=1, 2, 3, 4, 5, 6.
QP Curve Qn	The percentage of the output active power to the rated power at Pn point, n=1, 2, 3, 4, 5, 6.
QP Curve Output Response Time	The response time when the QP curve output response Mode is PT-1 behavior.

8.2.7 Setting MV Station Parameters

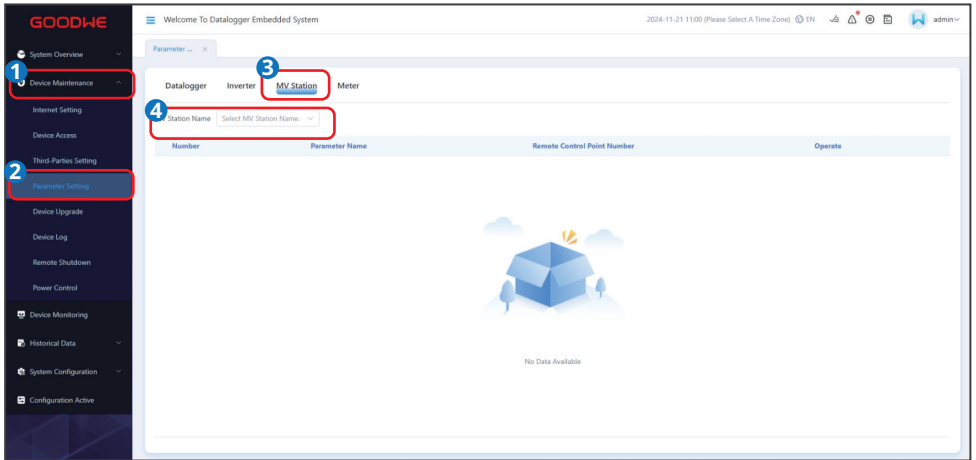

8.2.8 Setting Smart Meter Parameters

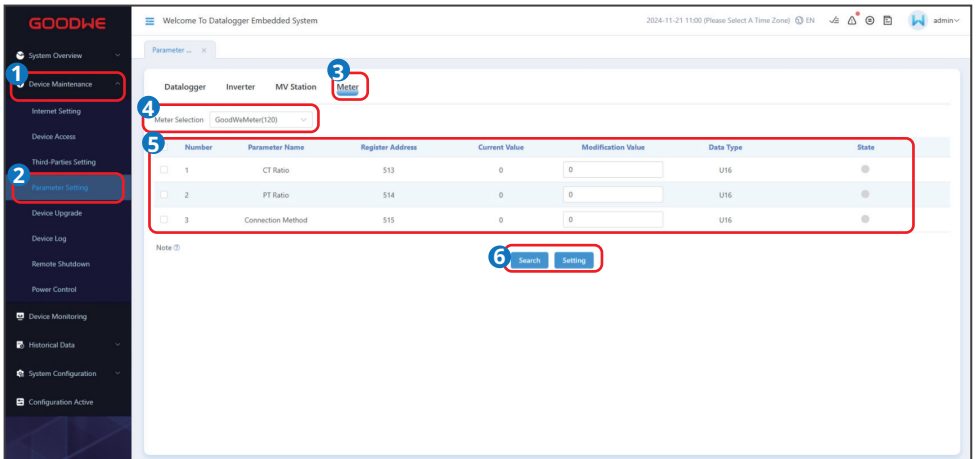

Parameter	Description
CT Ratio	Set the ratio of the primary current to the secondary current of the CT.
PT Ratio	Set the ratio of the primary voltage to the secondary voltage of the PT.
Connection Method	Set the connection method of the meter.

8.2.9 Setting Third Party Parameters

Set the forwarding parameters to forward the data collected by the EzLogger to a third party management platform.

IEC104 Parameters

Set IEC104 parameters when the EzLogger is connected to a management system through the IEC104 protocol.

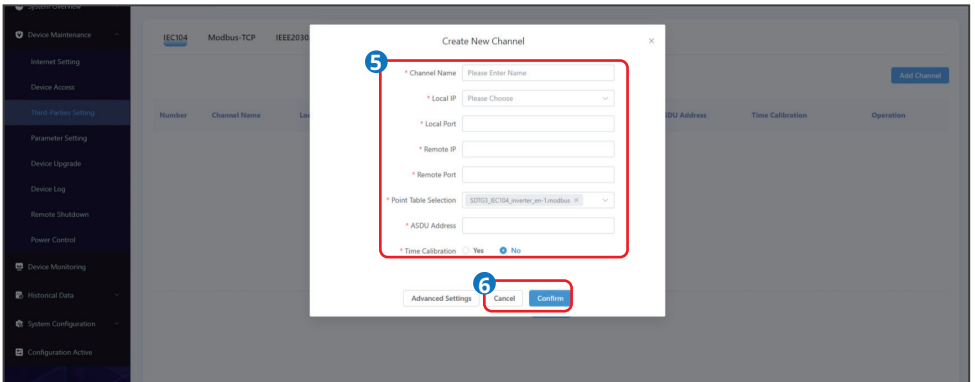
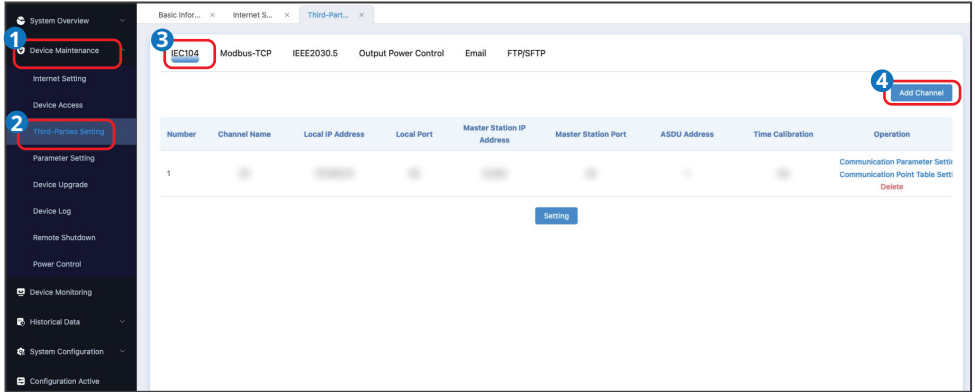

Parameter	Description
Channel Name	Define the device name based on actual needs.
Local IP	Set the IP address of the EzLogger.
Local Port	Set the port number of the EzLogger. Default port number: 2404.
Remote IP	Set the IP address of the IEC104 management system.
Remote Port	Set the port number of the IEC104 management system. Set it to 0 if the remote port number is not fixed.
Point Table Selection	Select the access point table.
ASDU Address	After importing the point table, the point table of the management system can be mapped when the setting the third party configuration. Select the parameter based on the actual situation.
Time calibration or not	Set time calibration with the remote device or not based on actual situation.

Modbus-TCP Parameters

Set Modbus-TCP parameters when EzLogger is connected to a management system through the Modbus-TCP protocol.

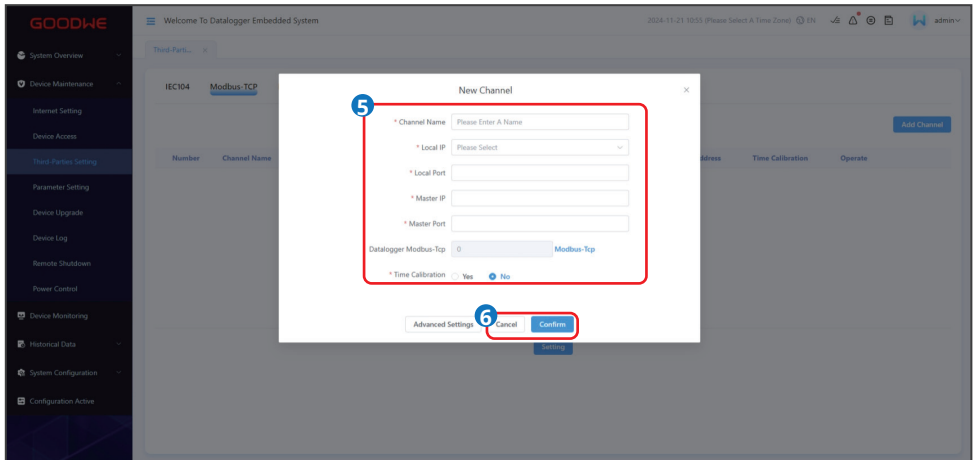
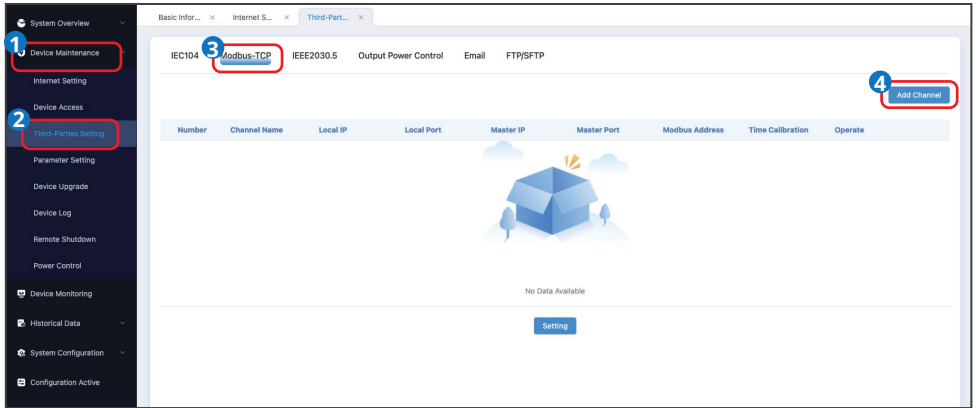

Parameter	Description
Channel Name	Define the device name based on actual needs.
Local IP	Set the IP address of the EzLogger.
Local Port	Set the port number of the EzLogger. Default port number: 502.
Master IP	Set the IP address of the Modbus-TCP management system.
Master Port	Set the port number of the Modbus-TCP management system.
Select Point Table	Select the access point table.
Datalogger Modbus-TCP	Set the address of the Modbus-TCP management system.
Time calibration or not	Set time calibration with the remote device or not based on actual situa-

IEEE2030.5

According to laws and regulations in North America and other regions, set the IEEE2030.5 parameters when the devices are communicating through IEEE2030.5 protocol.

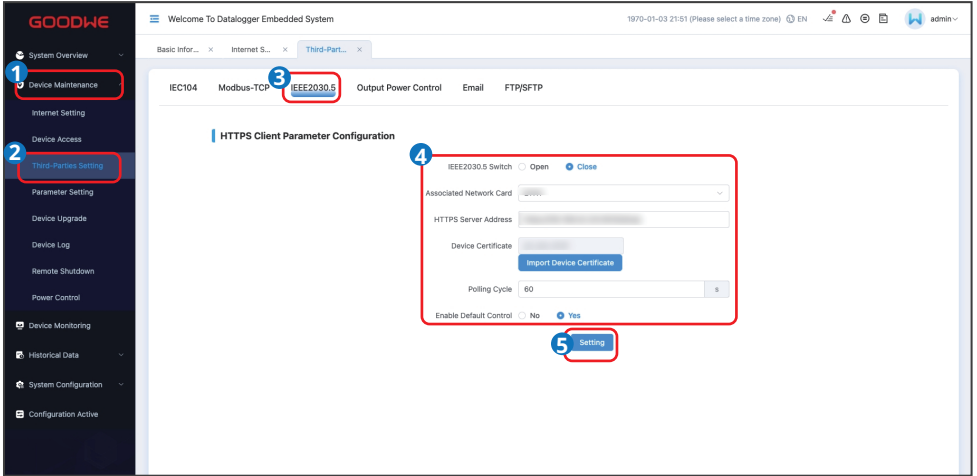

Parameter	Description
IEEE2030.5 Switch	Enable or disable IEEE2030.5.
Associated Network Card	Set the forwarding network port for IEEE2030.5 based on actual situation.
HTTPS Server Address	Set the HTTPS server address based on actual situation.
Device Certificate	Import the device certificate.
Polling Cycle	Set the polling cycle.
Enable Default Control	Enable or disable IEEE2030.5 default control.

Output Power Control

According to the requirements of Japan and other regions, set output control parameters when the device needs to communicate with utility grid company to realize output control function.

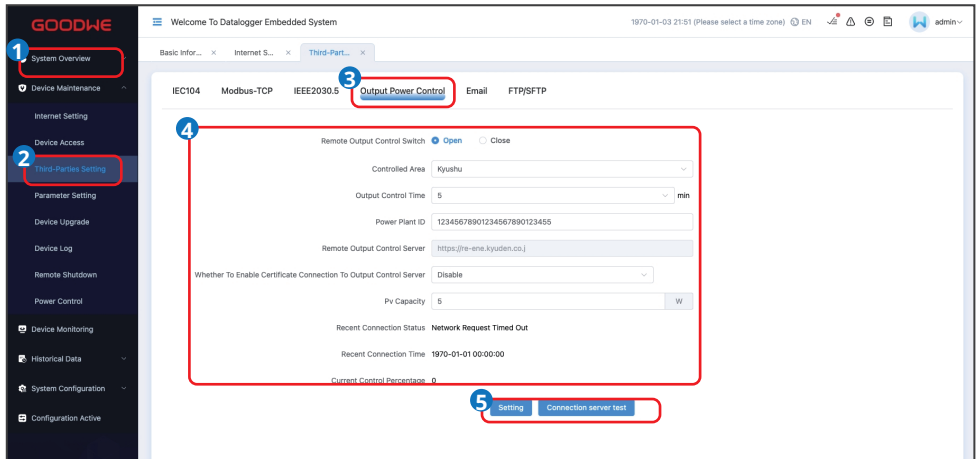

Parameter	Description
Remote Output Control Switch	Enable or disable the output control function.
Controlled Area	Set the output control area. Supported: None, Kyushu, Chubu, Kansai, Shikoku, Hokkaido, Tokyo, Tohoku, etc.
Output Control Time	Set the output control duration.
Power Plant ID	The ID assigned to the plant by the utility grid company after connecting its server.
Remote Output Control Server	The Remote Ouptu Contol Server will be generated automatically after setting the Control Region.
PV Capacity	Set the total capacity of the PV panels.

E-mail

- Send emails to update current generated energy, alarms, and device status, so that users can know the working status of the plant in time.
- Only 163, 126, and sina mailboxes are supported currently.

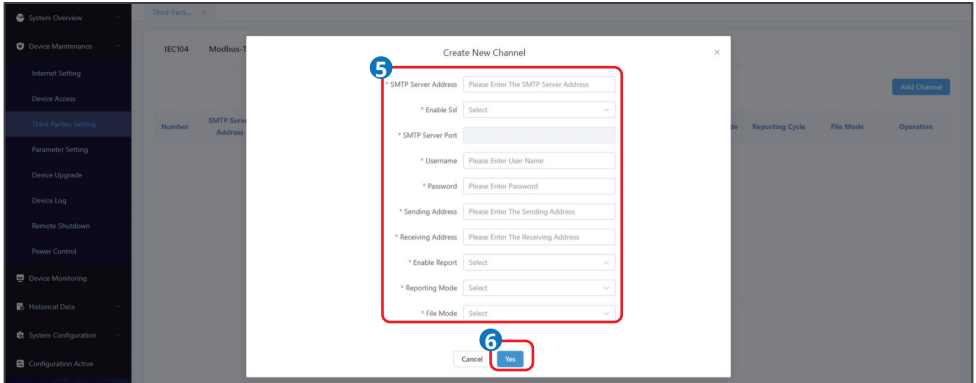
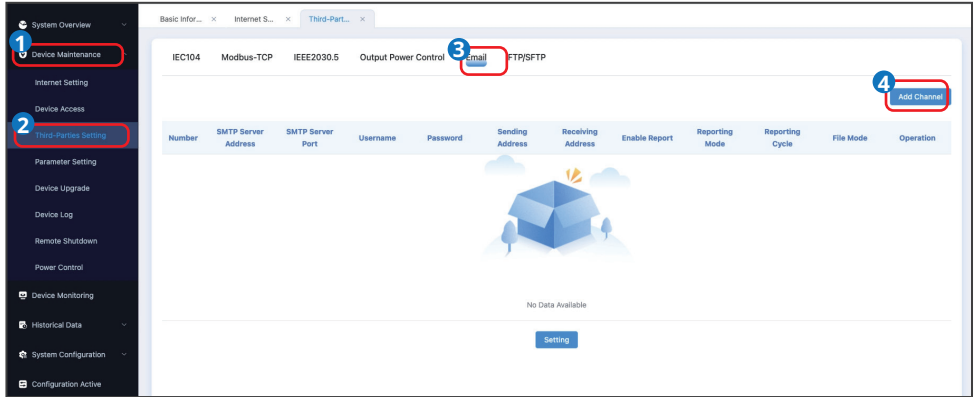

Parameter	Description
SMTP Server Address	Set the domain name or IP address of the SMTP server.
Enable SSL or not	Set whether to enable the SSL encryption.
SMTP Server Port	Set the port number of the SMTP server for email sending.
Username	Set the user name to log into the SMTP server.
Password	Set the password to log into the SMTP server.
Send Address	Set the sending email's address.
Receive Address	Set the receiving email's address.
Report or not	Set whether to send the emails.
Report Mode	Set the email sending mode to cycle or scheduled report. When the report mode is cycle report, set the cycle time to send emails. When the report mode is scheduled report, set the scheduled time to send emails.
File Mode	Select the equipment data to be sent in the emails. Currently supported: Full Data, Inverter Data, Point Table Data, or Relay Data.

FTP/SFTP

FTP/SFTP can be used to connect to the third-party management system. EzLogger can report the configuration information and running data of the managed power plant system through FTP/SFTP. The EzLogger can be connected to the third-party network management after it is configured correspondingly.

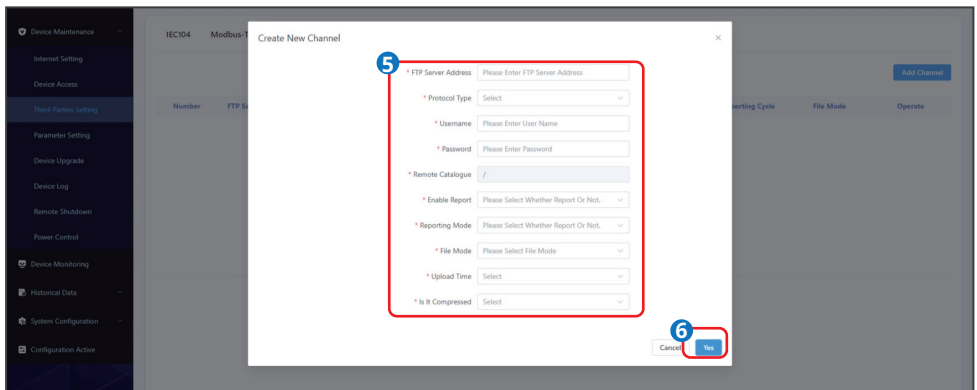
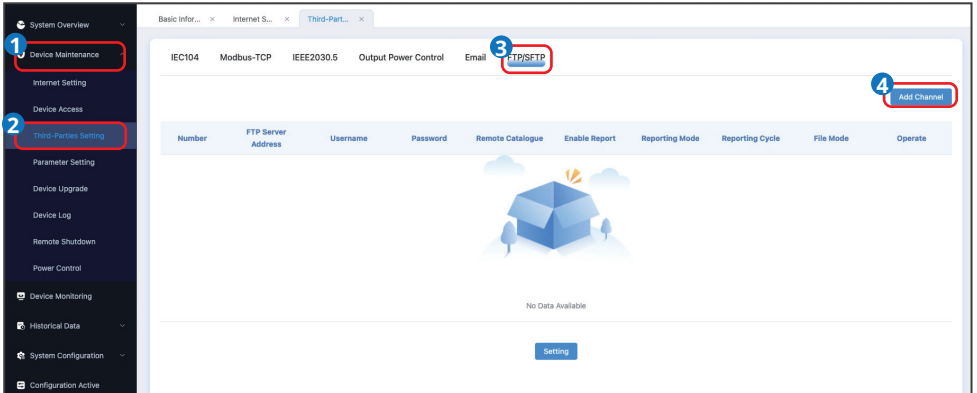

Parameter	Description
FTP Server Address	Set the domain name or IP address of the FTP server.
Username	Set the user name to log into the FTP server.
Password	Set the password to log into the FTP server.
Remote Directory	Create a subdirectory with the same name under the default directory specified by the FTP server, where the data will be uploaded.
Report or not	Set whether allows data reporting.
Report Mode	Set the mode for data uploading to cycle or scheduled report.. When the report mode is cycle report, set the cycle time to send emails. When the report mode is scheduled report, set the scheduled time to send emails.
File Mode	Select the type of data to be reported. Currently supported: Full Data, Inverter Data, Point Table Data, or Relay Data.

8.2.10 Setting Remote Shutdown

OVGR&RPR

The standards of Japan and some other regions require that the OVGR can connect to any DI port of the EzLogger to shut down the inverter over OVGR signals.

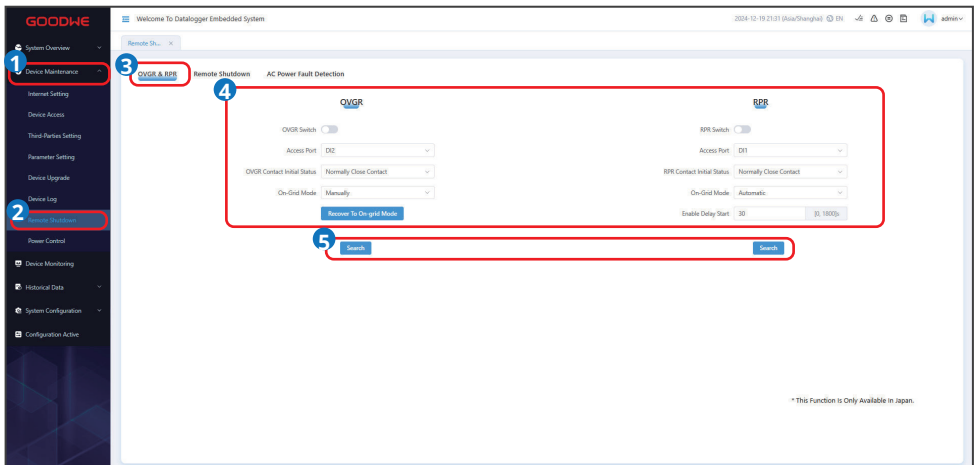
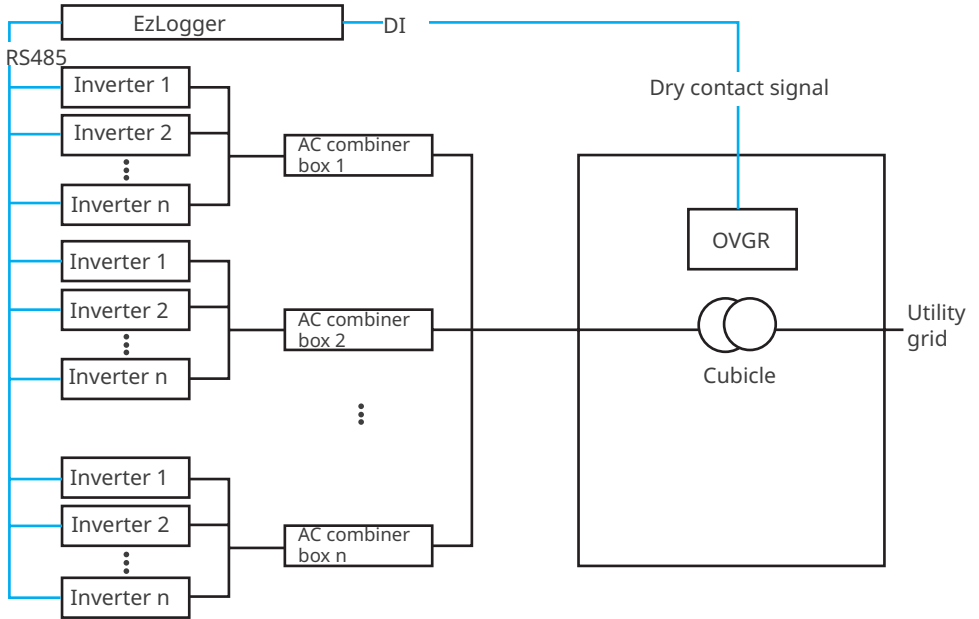

Parameter	Description
OVGR	
OVGR Switch	Enable or disable OVGR remote shutdown function.
Access Port	Select the actual port on the EzLogger which the OVGR is connected to. Supported: DI1, DI2, DI3, DI4, None.
OVGR Contact Initial Status	Set the initial status of OVGR. Supported: Normally Close Contact or Normally Open Contact.
On-grid Mode	Reconnect to the utility grid manually or automatically when the inverter is restarting due to remote shutdown.
Enable Delay Start	Set Enable Delay Start when the On-grid Mode is Automatic . The automatic on-grid connection will be delayed after the OVGR restores to the initial contact status.
Recover to On-grid Mode	If the On-grid Mode is Manual , click Recover to On-grid Mode to reconnect to the utility grid . If the On-grid Mode is Automatic , the inverter will reconnect to the utility grid automatically after the OVGR restores to the initial contact status.
RPR	
RPR Switch	Enable or disable RPR function.
Access Port	Select the actual port on the EzLogger which the RPR connected to. Supported: DI1, DI2, DI3, DI4, None.
RPR Contact Initial Status	Set the initial status of RPR. Supports: Normally Close Contact or Normally Open Contact.
On-grid Mode	Reconnect to the utility grid manually or automatically when the inverter is restarting due to remote shutdown.
Enable Delay Start	Set Enable Delay Start when the On-grid Mode is Automatic . The automatic on-grid connection will be delayed after the RPR restores to the initial contact status.
Recover to On-grid Mode	If the On-grid Mode is Manual , click Recover to On-grid Mode to reconnect to the utility grid . If the On-grid Mode is Automatic , the inverter will reconnect to the utility grid automatically after the OVGR restores to the initial contact status.

Remote Shutdown

- The standards of some countries and regions require that a remote shutdown device should be connected to the **AI1+** or **AI2+** port and **12V Output** port of the EzLogger to realize remote shutdown function.
- The remote shutdown device can detect the voltage and shutdown the inverter through AI1 or AI2 port.
- Once the remote shutdown device is disconnected, the voltage of AI1 or AI2 port will decrease to 0V and the inverter will be shut down. When the remote shutdown device is re-connected, the voltage of AI1 or AI2 port will increase to 12V. Click **Recover to On-grid Mode**, the inverter will restart and connect to the grid.

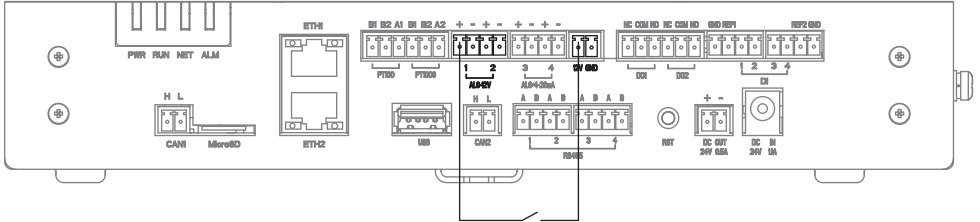

Remote shutdown device

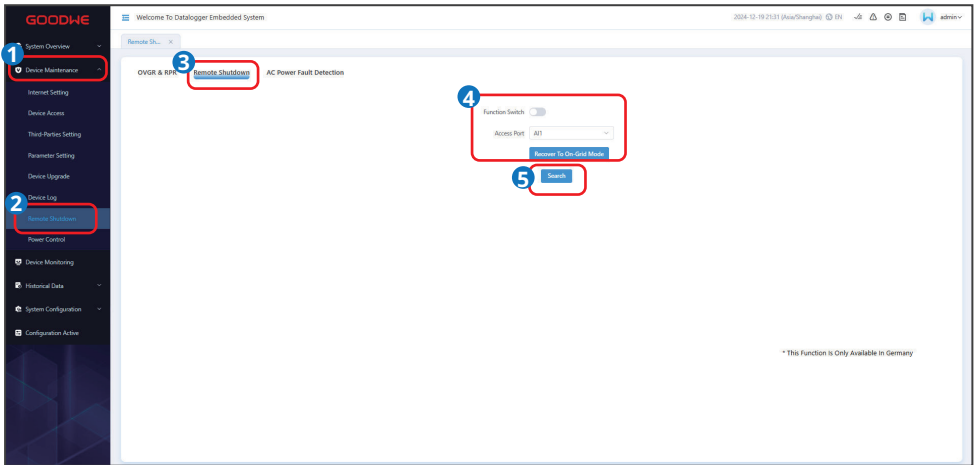

Parameter	Description
Function Switch	Enable or Disable remote shutdown function.
Access Port	Select the actual port on the EzLogger which the remote shutdown device is connected to. Supported: AI1 or AI2.
Recover to On Grid Mode	If the the inverter is power off, click Recover to On Grid Mode to restart and reconnect the inverter to the utility grid .

8.2.11 Setting Power Control Parameters

Power Limit

If the power generated by the PV system cannot be consumed by loads, the remaining power will be fed into the utility grid. Control the power fed into the grid by setting the Power-Limited Grid-Connected parameters.

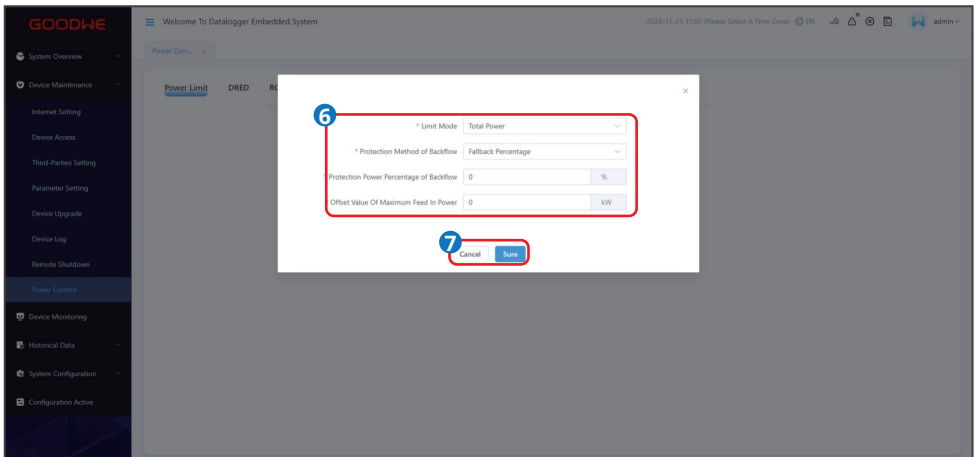
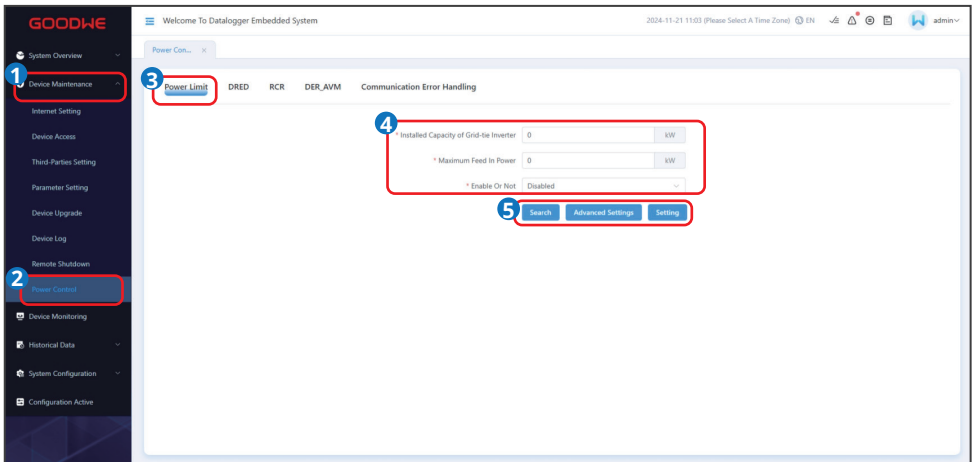
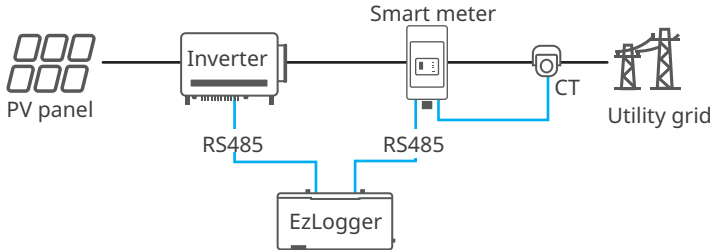

Parameter	Description
Installed Capacity of Grid-tie Inverter	Set the total capacity of all inverters in the system.
Maximum Feed In Power	Set the maximum power that is allowed feed into the utility grid based on local grid standards and requirements.
Enable or Not	Enable or disable Power Limite.
Limit Mode	Select the output power control mode based on actual situation. <ul style="list-style-type: none"> • Total Power: controls the total power at the grid-connection point to limit the power fed to the power grid. • Each Phase Power: controls the power of each phase at the grid-connection point to limit the power fed to the power grid.
Protection Method of Backflow	The power feed into the utility grid is allowed to exceed the limit value within a specified duration(5s by default). The following measures can be taken when output power exceeds the limit value more than the maximum allowed time: <ul style="list-style-type: none"> • Power Percentage: the equipment continues to work at the percentage of the rated power. • Device Offline: stop the equipment.
Protection Power Percentage of Backflow	The equipment works at the percentage of the rated power.
Offset Value Of Maximum Feed In Power	<ul style="list-style-type: none"> • Set the adjustable range of the maximum power to be exported to the utility grid. • Maximum power exported to the utility grid = maximum feed in power + offset value of maximum feed in power.

DRED

- The standards of Australia and other regions require that the inverter must pass DRM (DEMAND RESPONSE MODES) certification.
- To realize DRM, connect DRED (Demand Response Enabling Device) to **DI1/DI2/DI3/DI4/REF1/REF2** port of the EzLogger.

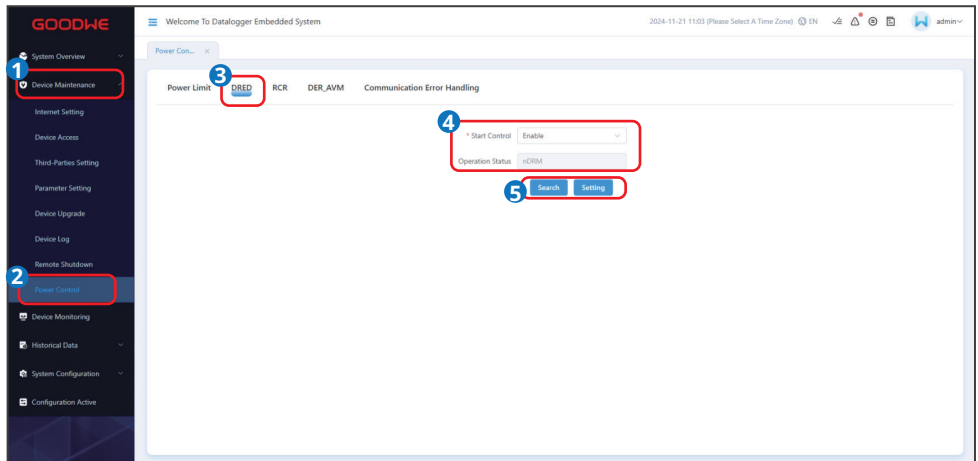
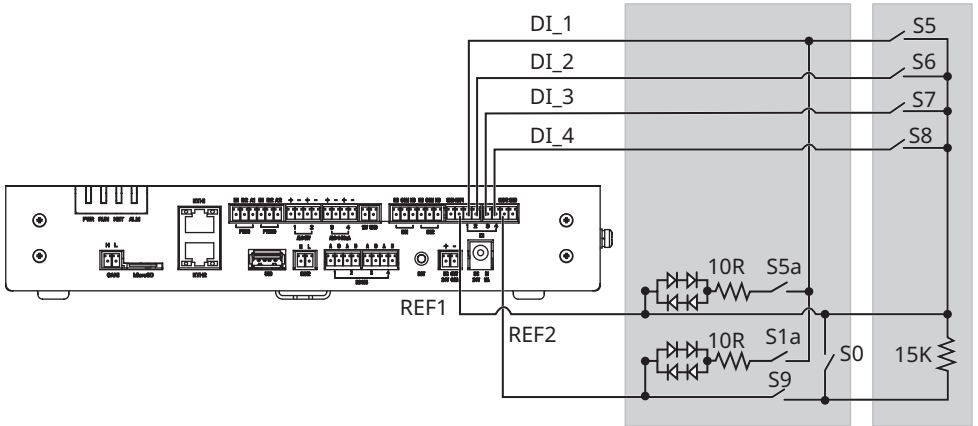

Parameter	Description
Start Control	Enable or disable DRED.
Operation Status	<ul style="list-style-type: none"> • The connection status of the device, including: nDRM, DRM5, DRM6, DRM7, DRM8. • nDRM: the device works at full power.

RCR

- The standards of German and other regions require that the inverter must provide signal controlling port for RCR (Ripple Control Receiver), which can be used for grid scheduling.
- To realize RCR, connect RCR to **DI1/DI2/DI3/DI4** port of the EzLogger.

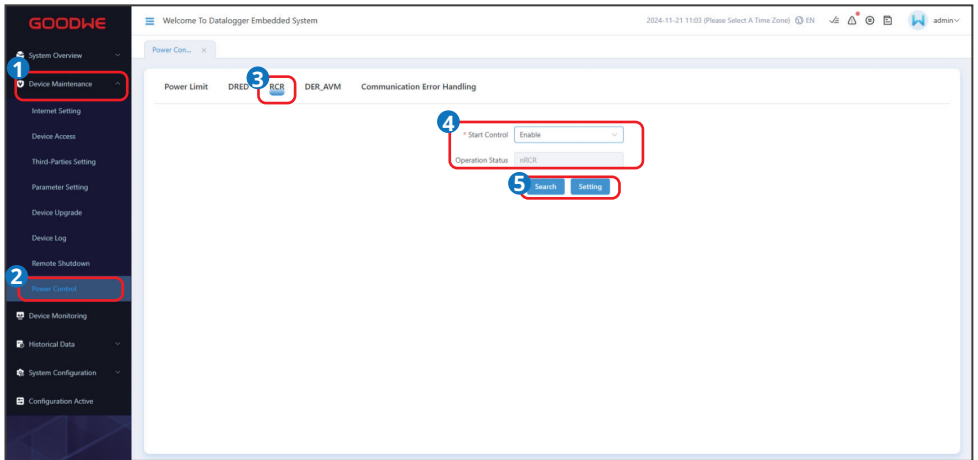
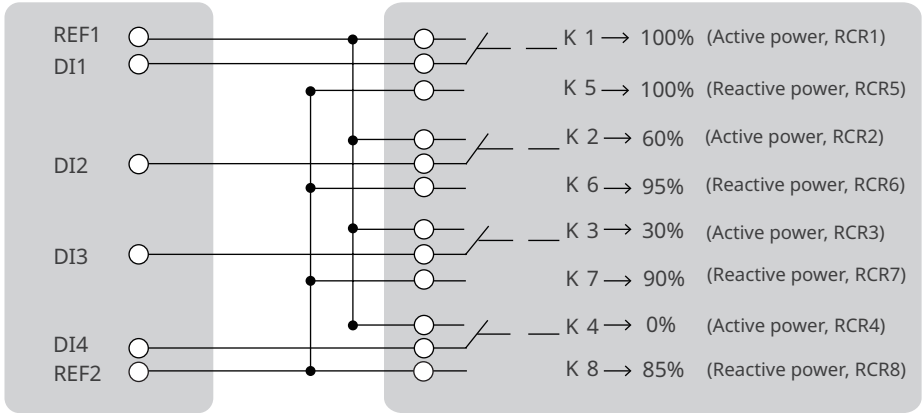

Parameter	Description
Start Control	Enable or disable RCR.
Operation Status	<ul style="list-style-type: none"> • The connection status of the device, including: nRCR, RCR1, RCR2, RCR3, RCR4, RCR5, RCR6, RCR7, RCR8. • nRCR: neither active power derating nor reactive power compensation is conducted.

DER_AVM

- The standards of Korea and other regions require that the inverters must provide a signal controlling port for DER_AVM, which can be used for grid scheduling.
- To realize DER_AVM, connect a third party KDN device to **RS485-4** of the EzLogger.

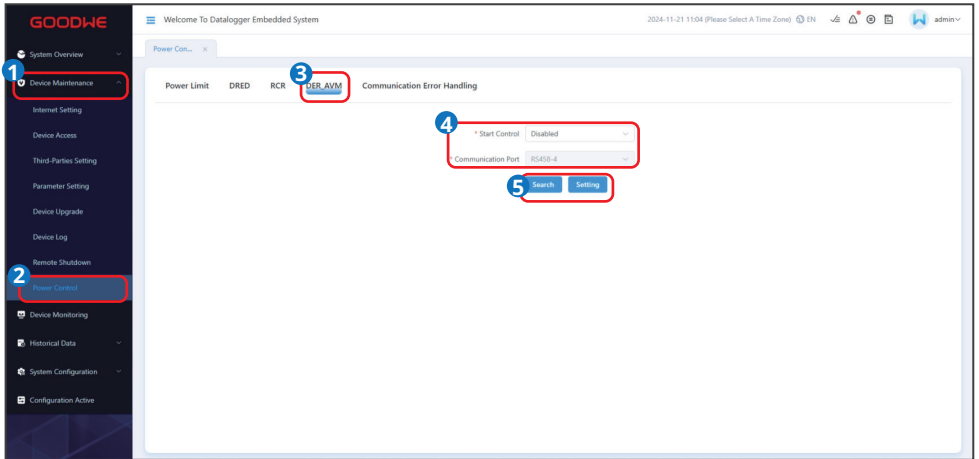

Parameter	Description
Start Control	Enable or disable DER_AVM.
Communication Port	Port for connecting the KDN device and the EzLogger. The default port is RS485-4.

Communication Error Handling

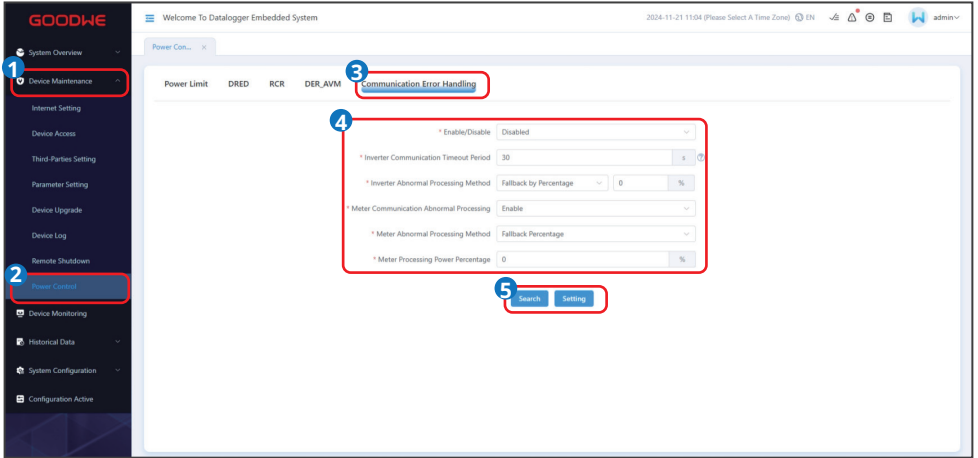

Parameter	Description
Enable/Disable	Enable Communication Error Handling, protective measures will be taken when the communication between the inverter and the EzLogger or the smart meter is abnormal.
Inverter Communication Timeout Period	The protective measures will be taken when the communication exception time exceeds the set time.
Inverter Abnormal Process Method	The following measures can be taken when the communication between the inverter and the EzLogger is abnormal: <ul style="list-style-type: none"> • Fallback by Percentage: the equipment continues to work at the percentage of the rated power. • Device Offgrid: stop the equipment.
Meter Communication Abnormal Processing	Enable Meter Communication Abnormal Processing, protective measures will be taken when the communication between the smart meter and the EzLogger is abnormal.
Meter Abnormal Processing Method	The following measures will be taken when the smart meter communication is abnormal. <ul style="list-style-type: none"> • Fallback by Percentage: the equipment continues to work at the percentage of the rated power. • Device Offline: stop the equipment.
Meter Processing Power Percentage	The equipment works at the percentage of the rated power.

8.3 Commissioning through SolarGo App

8.3.1 Downloading and Installing App

Make sure that the mobile phone meets the following requirements:

Mobile phone operating system: Android 4.3 or later, iOS 9.0 or later.

- The mobile phone can access the Internet.
- The mobile phone supports WLAN or Bluetooth.

Method 1: Search SolarGo in Google Play (Android) or App Store (iOS) to download and install the app.



Method 2: Scan the QR code below to download and install the App.

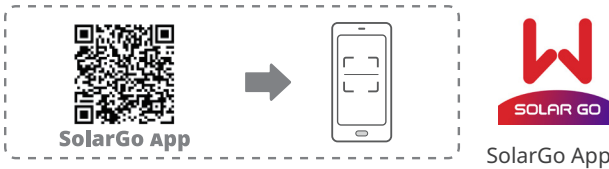

8.3.2 Login to the App

NOTICE

- Before connecting the EzLogger and the App, make sure:
 - Cellular WiFi is turned on
 - The devices are powered on and communicate properly with the EzLogger
 - The antenna of the EzLogger is connected properly and the signal of WiFi hotspot is stable.
 - SolarGo App version is V5.9.0 or above.
- To ensure account security, the same account can not be logged into the Web and SolarGo App at the same time.

Step 1 Open the WiFi settings on your phone and connect to the EzLogger's WiFi hotspot.

Default WiFi hotspot name: Log-*** (*** represents the EzLogger's serial number).

Default WiFi password: 12345678.

Step 2 Open the SolarGo App. Tap **WLAN** and search for devices, connect to the required device.

Step 3 Enter your username and password to log in to the App. Default username: admin.

Default password: 123456.

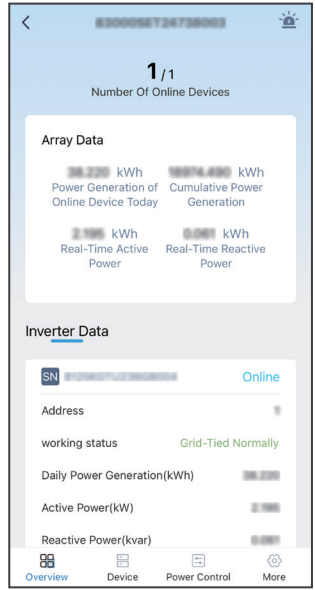
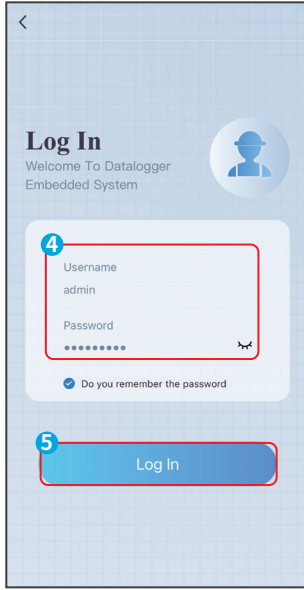
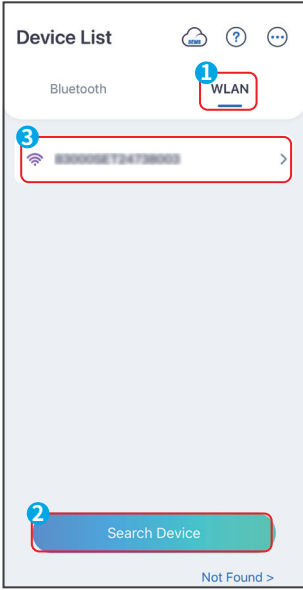

8.3.3 Introduction to the App

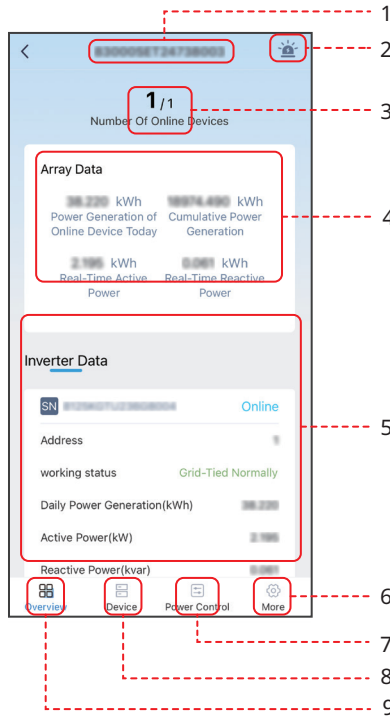

No.	Description
1	Serial number of the connected EzLogger.
2	Alarm information. Both real time alarm and historical alarm can be checked.
3	Number of online devices.
4	Power generation data of the system.
5	Inverter related data, such as device SN, working status, generation data, etc.
6	Overview. Tap to view the system information, such as online devices, PV data, inverter data, etc.
7	Device. Set the system network, add devices, delete devices, configure devices, and so on.
8	Power control. Set the power control function, like remote shutdown, DRED, RCR, etc.
9	More. Set network parameters, safety information, system time, etc.

8.3.4 Adding Devices

8.3.4.1 Adding Devices via Automatic Search

NOTICE

Third party devices like smart meter cannot be found by automatic search, add the third party device via manually add.

Step 1 Tap **Device > Networking Settings**.

Step 2 Tap **Start Searching**. Stop searching when the searched number of device matches actual number of device. Check the RS485 wiring if the searched number of device is not right.

Step 3 The App will prompt whether to assign an address with one click. Select **Confirm** or **Cancel** based on your actual needs. If you tap **Cancel**, then set the device terminal address manually. Ensure that device terminal addresses are unique.

Step 4 Check the networked device information and tap **Setting > Confirm > Take Effect Immediately > Confirm** to complete networking settings.

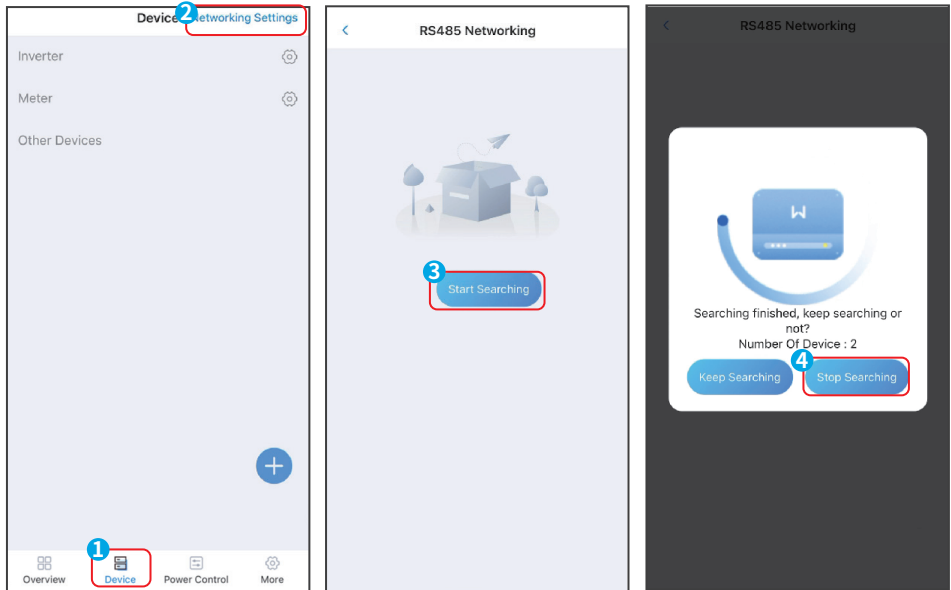

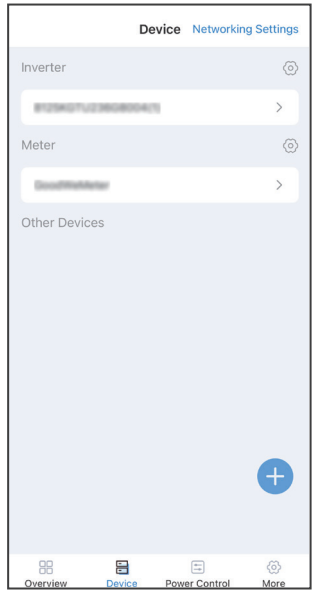
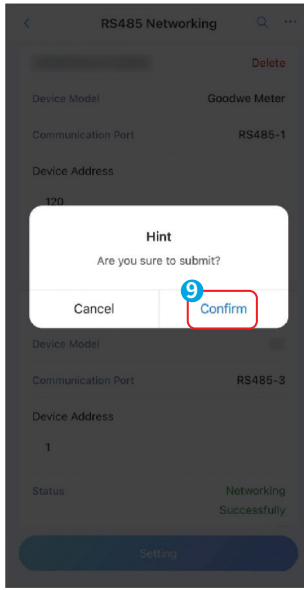
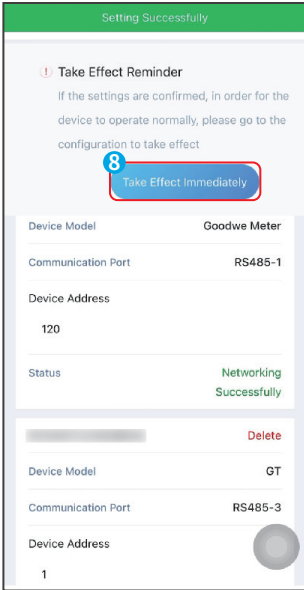
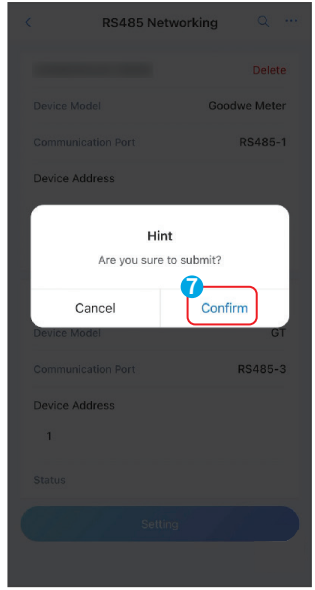
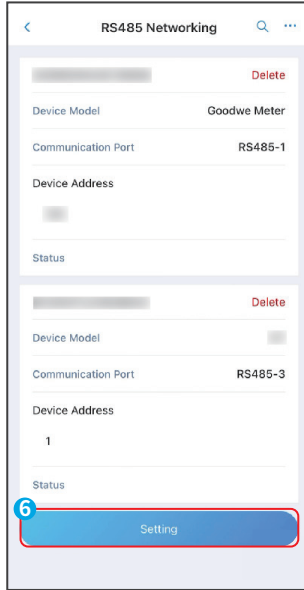
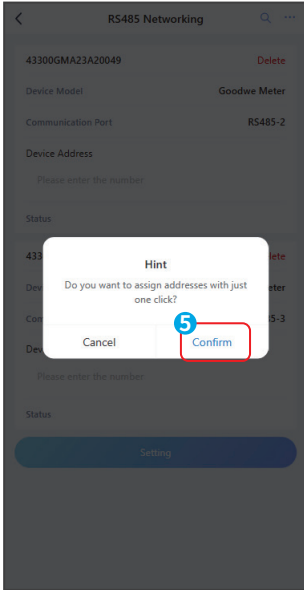

8.3.4.2 Adding Devices via Manually Add

NOTICE

Before adding a device, confirm the device model, device SN, and the communication port that the device is connected to. Otherwise, the adding may fail.

Step 1 Tap **Device** > **+** to add the devices.

Step 2 Select the required device type and enter the corresponding device information.

Step 3 Tap **Submit** to add the device.

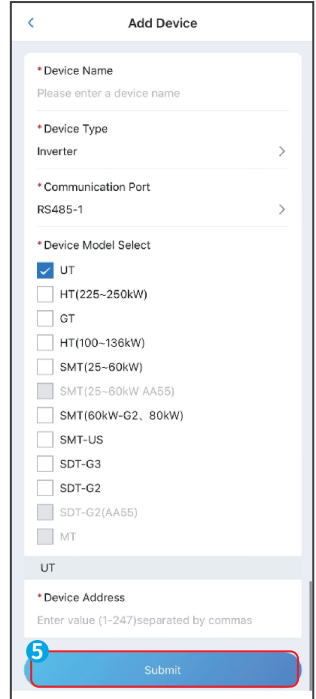
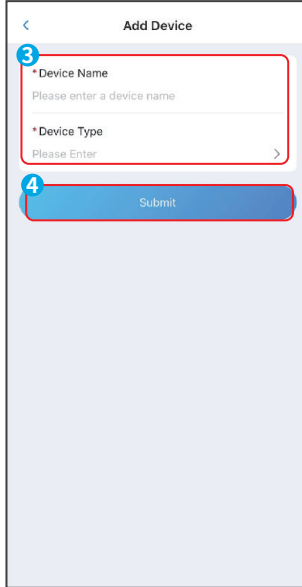
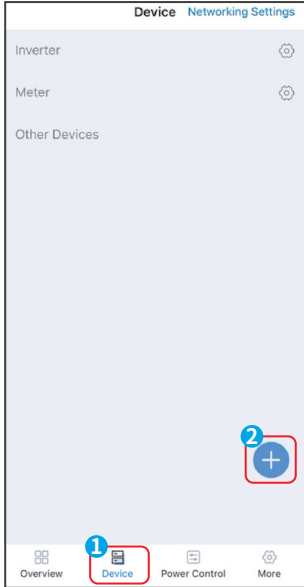

Add an inverter

Parameter	Description
Device Name	Define the device name based on actual needs.
Device Type	Select Inverter .
Communication Port	Select based on the actual port on the EzLogger which the inverter connected to. Supported port: RS485-1, RS485-2, RS485-3, RS485-4.
Select Device	Select the actual connected inverter model. Connect inverters of different models to one port is supported. UT and HT(225~250kW) can be connected to one RS485 communication port at the same time. GT, HT(100~136kW), SMT(25~60kW), SMT(80kW), SMT-US, SDT-G3 and SDT-G2 can be connected to one RS485 communication port at the same time.
Terminal Address	Device address. Set the parameter based on the actual power plant planning. Select Auto-Generate when there is no need to set the parameters based on the actual settings. Make sure that the terminal address is consistent with the communication address of the inverter on the SolarGo app.

Add a smart meter

Parameter	Description
Device Name	Define the device name based on actual needs.
Device Type	Select Smart Meter.
Communication Protocol	Set the parameter based on the communication protocol of the smart meter. Supported: Modbus-RTU.
Communication Port	Select the actual connected port on the EzLogger. Supported port: RS485-1, RS485-2, RS485-3, RS485-4.
Device Subtype	This option is displayed when the communication protocol is Modbus-RTU. Set this parameter based on the actual meter model. Supported: Goodwe Meter(GM330), UMG604PRO, Acrel-DTSD1352, Schneider-IEM3255, and Others.
Meter Purpose	<ul style="list-style-type: none"> Select based on the actual purpose. Supported: Grid Side Meter or Point Of Interconnection Meter Grid Side Meter: for power limiting, supports Goodwe Meter(GM330), UMG604PRO and Acrel-DTSD1352. Point Of Interconnection Meter: for metering, supports Schneider-IEM3255.
Terminal Address	Device address. Set the parameter based on the actual power plant planning. Select Auto Generate when there is no need to set the parameters based on the actual settings.
Access Point Table	Select the point table based on actual situation.

Add other devices

Parameter	Description
Device Name	Define the device name based on actual needs.
Device Type	Select Other Devices.
Communication Protocol	Select based on the communication protocol of the device. Support Modbus-RTU, Modbus-TCP and GW-XPB.
When the Communication Protocol is Modbus-RTU, set the following parameters based on actual situation:	
Communication Port	Select the actual connected port on the EzLogger. Supported port: RS485-1, RS485-2, RS485-3, RS485-4.
Device Subtype	Select the device type based on the actual situation. Supported: Weather Station, MV Station or Other.
MV Station Sub-Type	If the Device Subtype is MV Station, set the MV Station Sub-Type to General or Distributed.
Terminal Address	Device address. Set the parameter based on the actual power plant planning.
Protocol Type	Set the protocol type based on the actual situation.
Access Point Table	Import the access point table of the connected device.
IEC104 Forwarding	Select the forwarding table based on actual situation.
Modbus-TCP Forwarding	Select the forwarding table based on actual situation.
When the Communication Protocol is Modbus-TCP, set the following parameters based on actual situation:	
Communication Mode	Set the communication mode based on actual situation. Supported: UDP, TCPClient and TCPServer.
Local IP Address	Set the IP address of the net port of the EzLogger.
Local Port	Set the port number of the EzLogger. Default value: 502.
Remote IP Address	Set the IP address of the added device.
Remote Port	Set the port number of the added device. If the number is no fixed, set it to be 0.
Terminal Address	Device address. Set the parameter based on the actual power plant planning. Select Auto Generate when there is no need to set the parameters based on the actual settings.
When the Communication Protocol is GW-XPB, set the following parameters based on actual situation:	
Communication Port	Select the actual connected port on the EzLogger. Supported port: RS485-1, RS485-2, RS485-3, RS485-4.
Terminal Address	Device address. Set the parameter based on the actual power plant planning.

8.3.5 Setting Inverter Parameters

Step 1 Tap **Devices** > .

Step 2 Tap **Parameter Setting** and select the device. Tap **Confirm** to enter the parameter setting page.

Step 3 Search or modify the parameter based on actual needs.

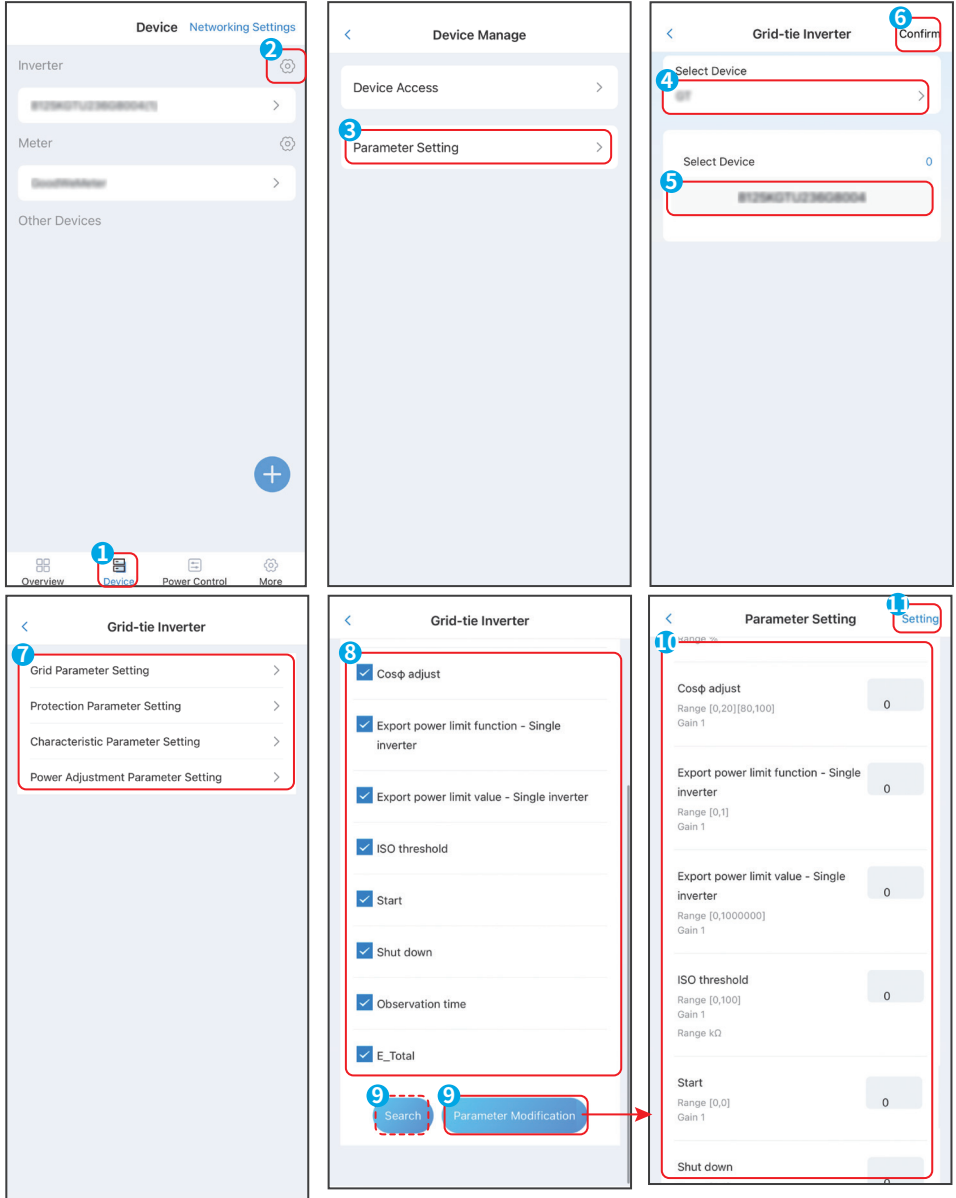

Grid Parameter Setting

Parameter	Description
Safety Code	Select based on the grid standards of the country/region where the inverter is located and its application scenario.
SPD Detection Switch	Enable or disable SPD detection function.
Power On (Allowing Grid-connection Self-test)	Issue power on instructions to allow grid connection self-test.
Shutdown (Not Allowing Grid-connection Self-test)	Issue power off instructions to stop grid connection self-test.
Output Method	<ul style="list-style-type: none"> Set whether the inverter's output includes the neutral (N) cable based on its application scenario. 0: three-phase four wire (3W/PE); 1: three phase five wire (3W/N/PE).
Shadow Scan Function Switch 1	PV strings may exist significant shading in PV systems where the inverter is applied. Enabling this feature, allows the inverter to perform a global MPPT scan at regular intervals to find the maximum power point.
Active Power Fixed Value Derating	Adjust the active power output of the inverter by fixed value.
Active Power Percentage Derating (0.1%)	Adjust the active power output of the inverter by percentage of rated power.
Reactive Power Compensation (PF)	Set the power factor of the inverter.
Reactive Power Compensation (Q/S)	Set the reactive power output from the inverter.
Reactive Power Compensation Fixed Value	Adjust the reactive power output of the inverter by fixed value.
Night Reactive Power Function Switch	Enable or disable night reactive power function. In some specific application scenarios, the power grid company requires that the inverter can perform reactive power compensation at night to ensure that the power factor of the local power grid meets requirements.
Night Reactive Power Parameters Taking Effect	Enable this function, the inverter outputs reactive power based on Fixed Value of Night Reactive Power Scheduling . Otherwise, the inverter executes the remote scheduling command.
Percentage of Night Reactive Power Scheduling (0.1%)	Schedule the reactive power by percentage during night reactive scheduling period.
Fixed Value of Night Reactive Power Scheduling	Schedule the reactive power by fixed value during night reactive scheduling period.

Protection Parameter Setting

Parameter	Description
Overvoltage Trigger n-order Value (0.1%)	Set the Level n overvoltage protection threshold, n=1, 2, 3, 4.
Overvoltage Trigger n-order Trip Time	Set the Level n overvoltage protection duration, n=1, 2, 3, 4.
Undervoltage Trigger n-order Value (0.1%)	Set the Level n undervoltage protection threshold, n=1, 2, 3, 4.
Undervoltage Trigger n-order Trip Time	Set the Level n undervoltage protection duration, n=1, 2, 3, 4.
10min Overvoltage Trigger Value (0.1%)	Set the 10-min overvoltage protection threshold.
10min Overvoltage Trip Time	Set the 10-min overvoltage protection duration.
Overfrequency Trigger n-order Value	Set the Level n overfrequency protection threshold, n=1, 2, 3, 4.
Overfrequency Trigger n-order Trip Time	Set the Level n overfrequency protection duration, n=1, 2, 3, 4.
Underfrequency Trigger n-order Value	Set the Level n underfrequency protection threshold, n=1, 2, 3, 4.
Underfrequency Trigger n-order Trip Time	Set the Level n underfrequency protection duration, n=1, 2, 3, 4.
Start-up Grid Connection Voltage Upper Limit	The inverter cannot connect to the grid if it is powered on for the first connection and the grid voltage is higher than the Start-up Grid Connection Voltage Upper Limit .
Start-up Grid Connection Voltage Lower Limit	The inverter cannot connect to the grid if it is powered on for the first connection and the grid voltage is lower than the Start-up Grid Connection Voltage Lower Limit .
Start-up Grid Connection Frequency Upper Limit	The inverter cannot connect to the grid if it is powered on for the first connection and the grid frequency is higher than the Start-up Grid Connection Frequency Upper Limit .
Start-up Grid Connection Frequency Lower Limit	The inverter cannot connect to the grid if it is powered on for the first connection and the grid frequency is lower than the Start-up Grid Connection Frequency Lower Limit .
Start-up Grid Connection Waiting Time	The waiting time for connecting the inverter to the grid when the inverter is powered on for the first connection.
Start-up Grid Connection Power Loading Rate (0.1%Pn/min)	Set the percentage of incremental output power per minute when the inverter is powered on for the first connection.
Reconnection Voltage Upper Limit	In some countries/regions, when the inverter is shut down due to a fault protection, it is not allowed to reconnect to the grid if the grid voltage is higher than the set value of the Reconnection Voltage Upper Limit .

Parameter	Description
Reconnection Voltage Lower Limit	In some countries/regions, when the inverter is shut down due to a fault protection, it is not allowed to reconnect to the grid if the grid voltage is lower than the set value of the Reconnection Voltage Lower Limit .
Reconnection Frequency Upper Limit	In some countries/regions, when the inverter is shut down due to a fault protection, it is not allowed to reconnect to the grid if the grid frequency is higher than the set value of the Reconnection Frequency Upper Limit .
Reconnection Frequency Lower Limit	In some countries/regions, when the inverter is shut down due to a fault protection, it is not allowed to reconnect to the grid if the grid frequency is lower than the set value of the Reconnection Frequency Lower Limit .
Reconnection Waiting Time	Set the waiting time for the inverter to restart after a grid failure is restored.
Reconnection Power Loading Rate (0.1%Pn/min)	Set the percentage of incremental output power per minute when the inverter is not powered on for the first connection. For example, setting Reconnection Power Loading Rate to 10 means the reconnection slope is 10%Prated/min.
LVRT Enable	Low voltage ride-through (LVRT) refers to the situation, when the grid experiences a short-term low voltage abnormality, the inverter cannot immediately disconnect from the grid and has to work for a period of time. Enable this function, the inverter's LVRT is being activated.
LVRT Depth n	The ratio of the ride through voltage to the rated voltage at a feature point during LVRT, n= 1, 2, 3, 4, 5, 6, 7.
Hold Time n	The ride through time at a feature point during LVRT, n= 1, 2, 3, 4, 5, 6, 7.
Judgment Threshold of Entering LVRT	Set the threshold for triggering LVRT. The threshold settings should meet the local grid standard.
Judgment Threshold of Exiting LVRT	Set the threshold for exiting LVRT. The threshold settings should meet the local grid standard.
LVRT Positive Sequence Reactive Power K Value	During LVRT, the inverter needs to generate positive sequence reactive power to support the grid. This parameter is used to set the positive-sequence reactive power generated by the inverter.
LVRT Zero Current Mode Enable	The standards of some countries/regions require that the output current during LVRT should be limited. Enable this function, the output current is less than 10% of the rated current during LVRT.
Threshold of Entering Voltage	After enabling LVRT Zero Current Mode Enable , the zero current mode starts if the power grid voltage is less than Threshold of Entering Voltage during LVRT.
HVRT Enable	High voltage ride-through (HVRT) refers to the situation, when the grid experiences a short-term high voltage abnormality, the inverter cannot immediately disconnect from the grid and has to work for a period of time. Enable this function, the inverter's HVRT is being activated.
HVRT Depth n	The ratio of the ride through voltage to the rated voltage at a feature point during HVRT, n= 1, 2, 3, 4, 5, 6, 7.

Parameter	Description
Hold Time n	The ride through time at a feature point during HVRT, n= 1, 2, 3, 4, 5, 6, 7.
Judgment Threshold of Entering HVRT	Set the threshold for triggering HVRT. The threshold settings should meet the local grid standard.
Judgment Threshold of Exiting HVRT	Set the threshold for exiting HVRT. The threshold settings should meet the local grid standard.
HVRT Positive Sequence Reactive Power K Value	During HVRT, the inverter needs to generate positive sequence reactive power to support the grid. This parameter is used to set the positive-sequence reactive power generated by the inverter.
HVRT Zero Current Mode Enable	The standards of some countries/regions require that the output current during HVRT should be limited. Enable this function to set the output current less than 10% of the rated current during HVRT.
Threshold of Entering Voltage	After enabling HVRT Zero Current Mode Enable , the zero current mode starts if the power grid voltage is higher than Threshold of Entering Voltage during HVRT.
Current Sharing Mode	<ul style="list-style-type: none"> Set the sharing mode of reactive current and active current. 0: reactive power priority; 1: active power priority; 2: constant current mode.
Active Power Recovery Mode After Riding Through	<ul style="list-style-type: none"> Active current recovery mode during ride-through recovery, supported mode: slope recovery, first-order LPF recovery, and no requirement. 0: disable; 1: slope response; 2: time constant; 3: respond time
Active Power Recovery Rate After Riding Through	The rate at which the active current recovers during the ride through recovery process.
Active Power Recovery First-order LPF After Riding Through	The active current recovers at the characteristic of first order LPF after the ride through recovery.
Reactive Power Recovery Mode After Riding Through	<ul style="list-style-type: none"> Reactive current recovery mode during ride-through recovery, supported mode: slope recovery, first-order LPF recovery, and no requirement. 0: disable; 1: slope response; 2: time constant; 3: respond time
Reactive Power Recovery Rate After Riding Through	The reactive current recovers at the slope after the ride through recovery.
Reactive Power Recovery First-order LPF After Riding Through	The reactive current recovers at the characteristic of first order LPF after the ride through recovery.
Frequency Riding Through Enable	After enabling Frequency Riding Through Enable, the inverter continues to generate power during required time even the grid frequency is abnormal.
n-order Under Frequency Riding Through Point_UFn	Set the level n underfrequency protection threshold value, n=first, second, third.

Parameter	Description
n-order Under Frequency Riding Through Time_UTn	Set the level n underfrequency protection tripping time, n=first, second, third.
n-order Over Frequency Riding Through Point_OFn	Set the level n overfrequency protection threshold value, n=first, second, third.
n-order Over Frequency Riding Through Time_OTn	Set the level n overfrequency protection tripping time, n=first, second, third

Characteristic Parameter Setting

Parameter	Description
EU Remote Shutdown Enable	Enable or disable remote shutdown function.
Anti-PID Function Switch	Enable or disable anti-PID.
PID Recovery Function Switch	Enable or disable PID recovery.
Power Limit Switch	Enable or disable power limit.
Back Flow Power Percentage Setting	Set the back flow power by percentage.
Three-phase Power Limit Method Selection	<ul style="list-style-type: none"> Set the power limit mode. 0: the total power of the three phases cannot exceed the power limit. 1: power of any phase cannot exceed the power limit.
External Meter CT Ratio	Set the CT ratio of the smart meter.
ISO Threshold Setting	To protect the equipment, the inverter performs an insulation impedance check on the input side during self-check at startup. If the measured value is lower than the set value, the inverter will not connect to the grid.
NPE Overvoltage Detection Switch	Enable or disable N-PE overvoltage detection.
N-PE Error Threshold	Set the N-PE overvoltage alarm threshold.
Active Power Scheduling Response Method	<ul style="list-style-type: none"> Set the active power scheduling response method. Supported method: gradient control or PT-1 behavior. 0: disable; 1: gradient control; 2: PT-1 behavior tau; 3: PT-1 behavior respond time.
Gradient of Active Power	Set the active power change slope.
Active Power Scheduling LPF Time	Set the low pass filtering time for active power scheduling.

Parameter	Description
Reactive Scheduling Response Method	<ul style="list-style-type: none"> Set the reactive power scheduling response method. Supported method: gradient control or PT-1 behavior. 0: disable; 1: gradient control; 2: PT-1 behavior tau; 3: PT-1 behavior respond time.
Gradient of Reactive Power	Reactive Power Scheduling LPF Time
Set the low pass filtering time for reactive power scheduling	Set the low pass filtering time for reactive power scheduling.

Power Adjustment Parameter Setting

Parameter	Description
Power Baseline of Over Frequency Derating	The active power of the device will be derated according to a certain slope when the grid frequency exceeds overfrequency derating limit.
Under Frequency Loading Reference Mode	The active power of the device will be derated according to a certain slope when the grid frequency is lower than underfrequency derating limit.
Underfrequency Power Slope	The inverter output active power will change when the utility grid frequency is lower than the underfrequency limit. Indicates the slope when the inverter output power decreases.
PU Curve Enable	Enable or disable PU curve.
Vn Voltage Value (0.1%)	The percentage of actual voltage to the rated voltage at Vn point, n=1, 2, 3, 4.
Vn Active Power Value (0.1%)	The percentage of the output active power to the apparent power at Vn point, n=1, 2, 3, 4.
PU Curve Output Response Mode	The output response mode of the PU curve. Supported mode: gradient control or PT-1 behavior.
PU Curve Output Power Changing Rate	The power change slope when the PU Curve Output Response Mode is gradient control.
PU Curve Response Time Parameter	The response time when the PU Curve Output Response Mode is PT-1 behavior.
QU Curve Enable	Enable or disable PU Curve.
Vn Voltage Value (0.1%)	The percentage of actual voltage to the rated voltage at Vn point, n=1, 2, 3, 4.
Vn Active Power Value (0.1%)	The percentage of the reactive output power to the apparent power at Vn point, n=1, 2, 3, 4.
QU Curve Response Time Parameter	The response time when the QU curve output response Mode is PT-1 behavior.

Parameter	Description
Enter Curve Power (0.1%)	When the inverter output reactive power to the rated power ratio is between the Enter Curve Power and Exit Curve Power , the ratio meets QU curve requirements.
Exit Curve Power (0.1%)	
cosφ(P) Curve Enable Bit	Enable or disable cosφ(P) curve.
Point n Power (0.1%)	The percentage of the inverter output active power to the rated power at point A/B/C/ D/E.
point n cosφ Value (pf,0.001)	The power factor at point A/B/C/ D/E.
cosφ(P) Curve Response Time	The response time when the cosφ(P) curve response Mode is PT-1 behavior.
Enter Curve Voltage (0.1%)	When the grid voltage is between Enter Curve Voltage and Exit Curve Voltage, the voltage meets Cosφ curve requirements.
Exit Curve Voltage (0.1%)	When the grid voltage is between Enter Curve Voltage and Exit Curve Voltage, the voltage meets Cosφ curve requirements.
QP Curve Post Enable	Enable or disable QP curve.
QP Curve Pn	The percentage of the output active power to the rated power at Pn point, n=1, 2, 3, 4, 5, 6.
QP Curve Qn	The percentage of the output active power to the rated power at Pn point, n=1, 2, 3, 4, 5, 6.
QP Curve Output Response Time	The response time when the QP curve output response Mode is PT-1 behavior.

8.3.6 Setting the Meter Parameters

Step 1 Tap **Devices** > .

Step 2 Tap **Go To Parameter Setting** and select the parameter to be set.

Step 3 Tap **Read** to get current parameter values or tap **Parameter Issued** to set the parameters.

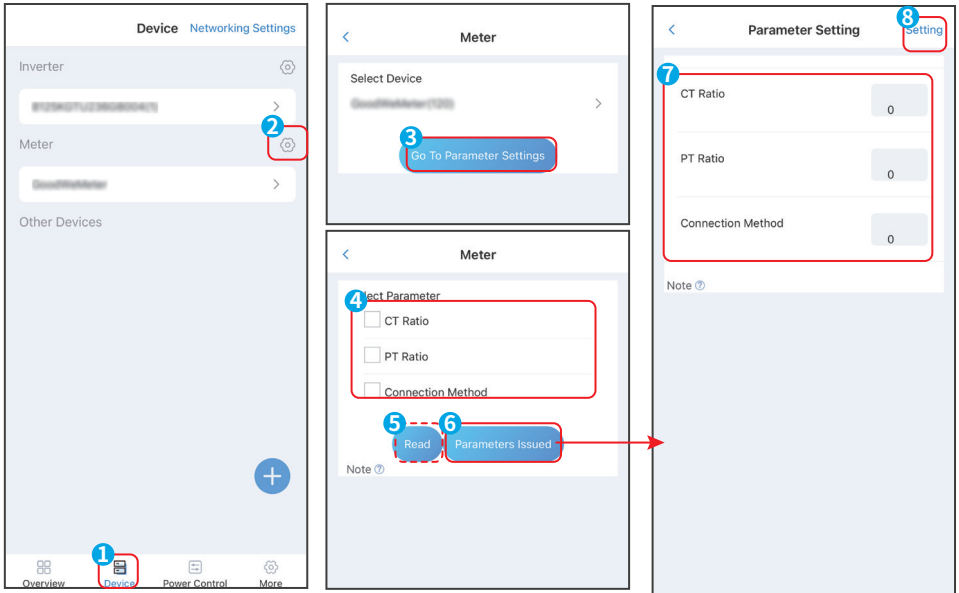

Parameter	Description
CT Ratio	Set the ratio of the primary current to the secondary current of the CT.
PT Ratio	Set the ratio of the primary voltage to the secondary voltage of the PT.
Connection Method	Set the connection method of the meter.

8.3.7 Setting Power Control Parameters

8.3.7.1 Setting Remote Shutdown

OVGR&RPR

The standards of Japan and some other regions require that the OVGR can connect to any DI port of the EzLogger to shut down the inverter over OVGR signals.

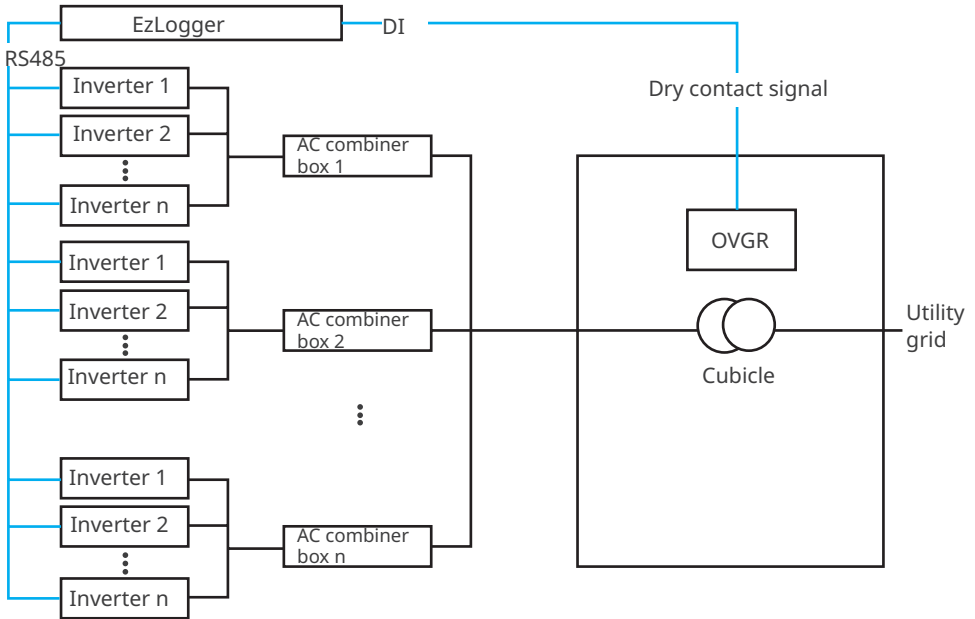

- Step 1** Tap **Power Control > Remote Shutdown > OVGR&RPR**.
- Step 2** Enable or disable OVGR or RPR based on actual needs.

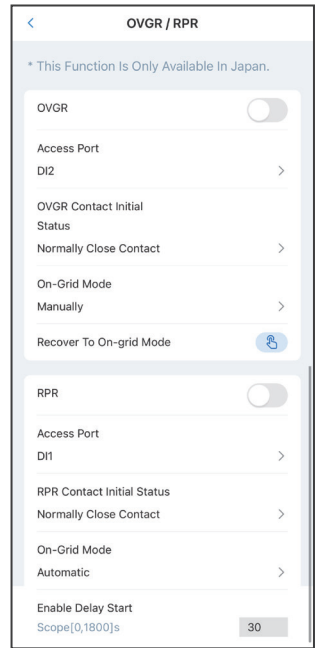
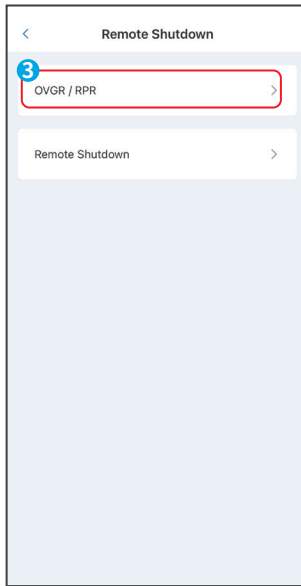
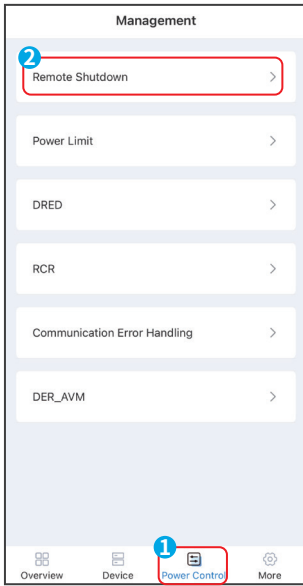

Parameter	Description
OVGR	
OVGR Switch	Enable or disable OVGR remote shutdown function.
Access Port	Select the actual port on the EzLogger which the OVGR is connected to. Supported: DI1, DI2, DI3, DI4, None.
OVGR Contact Initial Status	Set the initial status of OVGR. Supported: Normally Close Contact or Normally Open Contact.
On-grid Mode	Reconnect to the utility grid manually or automatically when the inverter is restarting due to remote shutdown.
Enable Delay Start	Set Enable Delay Start when the On-grid Mode is Automatic . The automatic on-grid connection will be delayed after the OVGR restores to the initial contact status.
Recover to On-grid Mode	If the On-grid Mode is Manual , click Recover to On-grid Mode to reconnect to the utility grid . If the On-grid Mode is Automatic , the inverter will reconnect to the utility grid automatically after the OVGR restores to the initial contact status.
RPR	
RPR Switch	Enable or disable RPR function.
Access Port	Select the actual port on the EzLogger which the RPR connected to. Supported: DI1, DI2, DI3, DI4, None.
RPR Contact Initial Status	Set the initial status of RPR. Supports: Normally Close Contact or Normally Open Contact.

Parameter	Description
On-grid Mode	Reconnect to the utility grid manually or automatically when the inverter is restarting due to remote shutdown.
Enable Delay Start	Set Enable Delay Start when the On-grid Mode is Automatic . The automatic on-grid connection will be delayed after the RPR restores to the initial contact status.
Recover to On-grid Mode	If the On-grid Mode is Manual , click Recover to On-grid Mode to reconnect to the utility grid . If the On-grid Mode is Automatic , the inverter will reconnect to the utility grid automatically after the OVGR restores to the initial contact status.

Remote Shutdown

- The standards of some countries and regions require that a remote shutdown device should be connected to the **AI1+** or **AI2+** port and **12V Output** port of the EzLogger to realize remote shutdown function.
- The remote shutdown device can detect the voltage and shutdown the inverter through AI1 or AI2 port.
- Once the remote shutdown device is disconnected, the voltage of AI1 or AI2 port will decrease to 0V and the inverter will be shut down. When the remote shutdown device is reconnected, the voltage of AI1 or AI2 port will increase to 12V. Click **Recover to On-grid Mode**, the inverter will restart and connect to the grid.

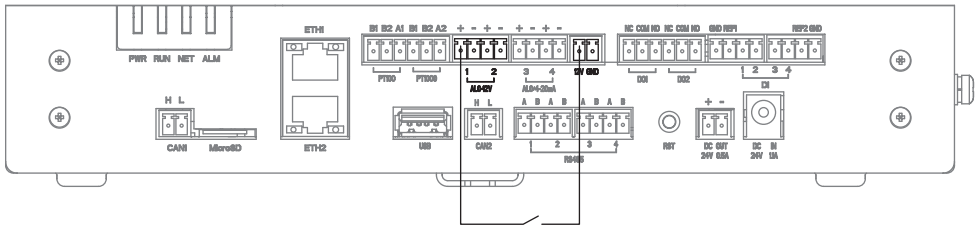

Remote shutdown device

- Step 1** Tap **Power Control > Remote Shutdown > Remote Shutdown**.
- Step 2** Enable or disable Remote Shutdown based on actual needs.

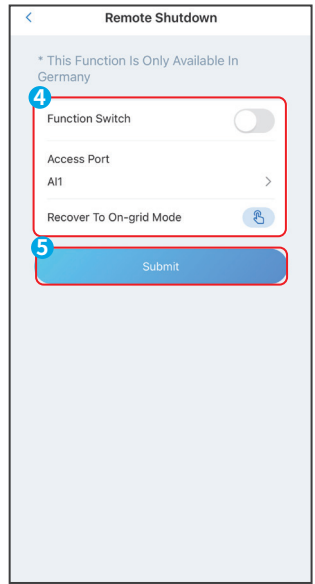
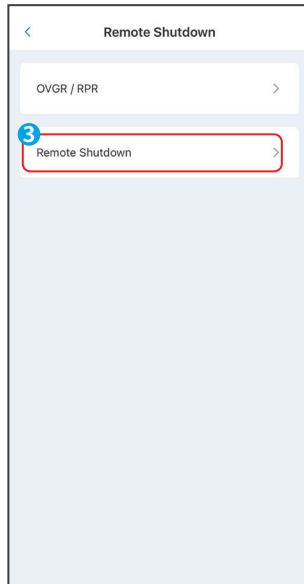
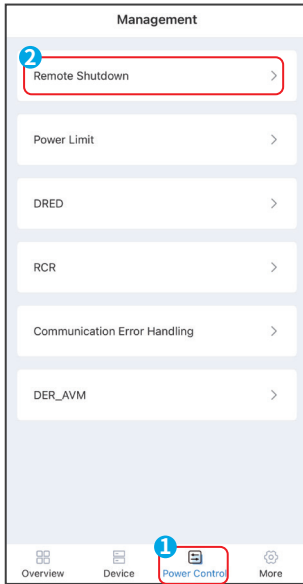

Parameter	Description
Function Switch	Enable or Disable remote shutdown function.
Access Port	Select the actual port on the EzLogger which the remote shutdown device is connected to. Supported: AI1 or AI2.
Recover to On-grid Mode	If the the inverter is power off, click Recover to On-grid Mode to restart and reconnect the inverter to the utility grid .

8.3.7.2 Setting Power Limit Parameters

If the power generated by the PV system cannot be consumed by loads, the remaining power will be fed into the utility grid. Control the power fed into the grid by setting the Power-Limited Grid-Connected parameters.

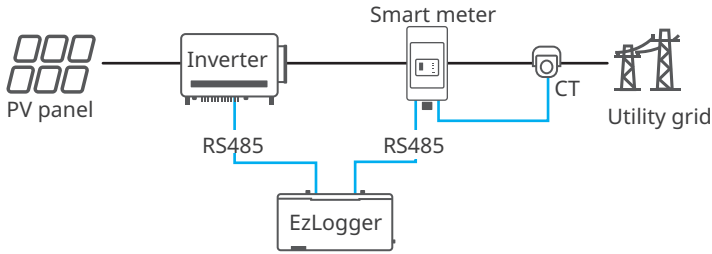

Step 1 Tap **Power Control > Power Limit**.

Step 2 Set the power limit parameter based on actual needs.

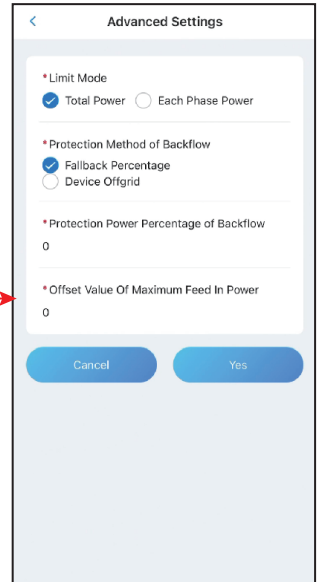
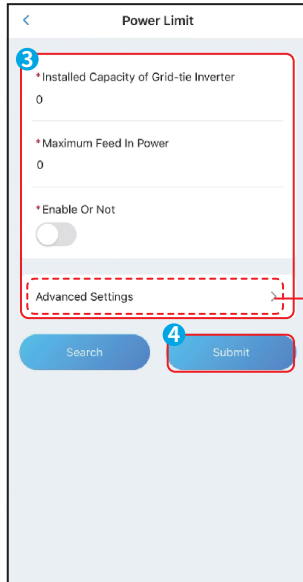
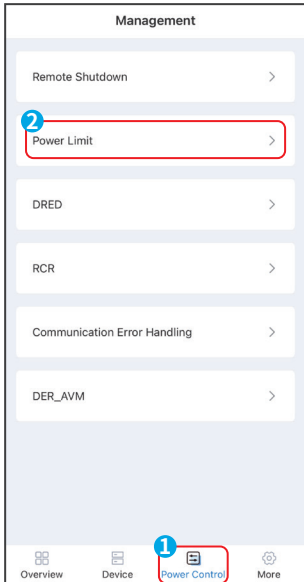

Parameter	Description
Installed Capacity of Grid-tie Inverter	Set the total capacity of all inverters in the system.
Maximum Feed In Power	Set the maximum power that is allowed feed into the utility grid based on local grid standards and requirements.
Start Control	Enable or disable Power-Limited Grid-Connected.
Limit Mode	<p>Select the output power control mode based on actual situation.</p> <ul style="list-style-type: none"> • Total Power: controls the total power at the grid-connection point to limit the power fed to the power grid. • Each Phase Power: controls the power of each phase at the grid-connection point to limit the power fed to the power grid.
Protection Method of Backflow	<p>The power feed into the utility grid is allowed to exceed the limit value within a specified duration(5s by default). The following measures can be taken when output power exceeds the limit value more than the maximum allowed time:</p> <ul style="list-style-type: none"> • Fallback Percentage: the equipment continues to work at the percentage of the rated power. • Device Offgrid: stop the equipment.
Protection Power Percentage of Backflow	The equipment works at the percentage of the rated power.
Offset Value Of Maximum Feed In Power	<ul style="list-style-type: none"> • Set the adjustable range of the maximum power to be exported to the utility grid. • Maximum power exported to the utility grid = maximum feed in power + offset value of maximum feed in power.

8.3.7.3 Setting DRED

- The standards of Australia and other regions require that the inverter must pass DRM (DEMAND RESPONSE MODES) certification.
- To realize DRM, connect DRED (Demand Response Enabling Device) to **DI1/DI2/DI3/DI4/REF1/REF2** port of the EzLogger.

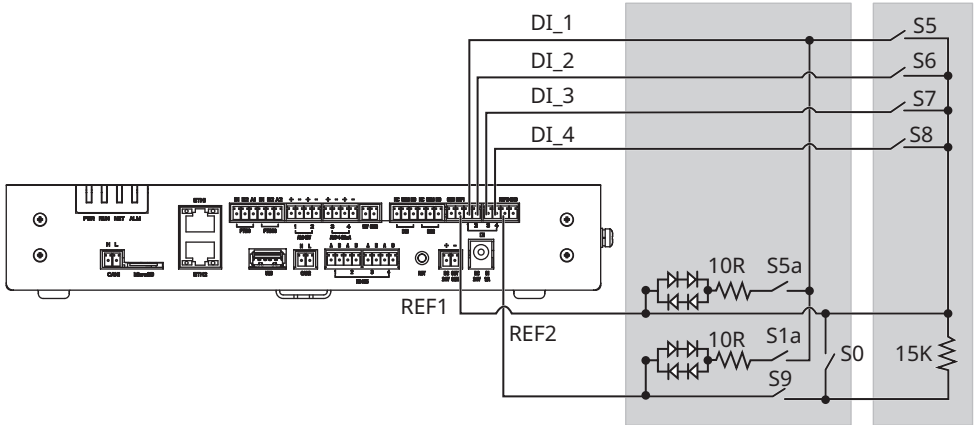

Step 1 Tap **Power Control > DRED**.

Step 2 Enable or disable DRED based on actual needs.

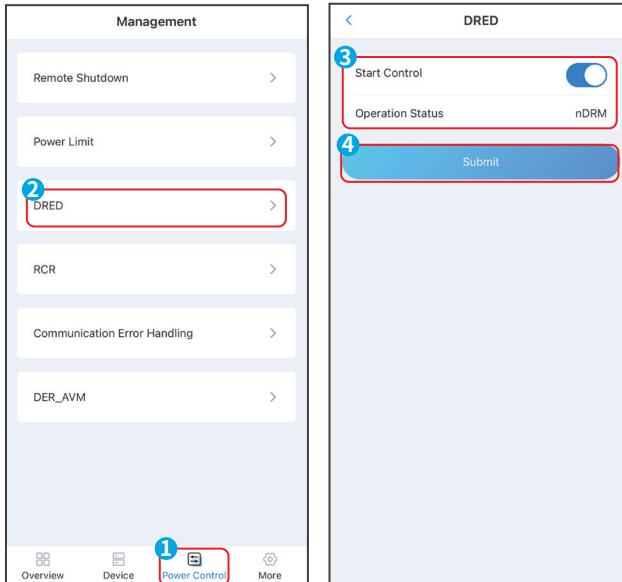

Parameter	Description
Start Control	Enable or disable DRED.
Operation Status	<ul style="list-style-type: none"> • The connection status of the device, including: nDRM, DRM5, DRM6, DRM7, DRM8. • nDRM: the device works at full power.

8.3.7.4 Setting RCR

- The standards of German and other regions require that the inverter must provide signal controlling port for RCR (Ripple Control Receiver), which can be used for grid scheduling.
- To realize RCR, connect RCR to **DI1/DI2/DI3/DI4** port of the EzLogger.

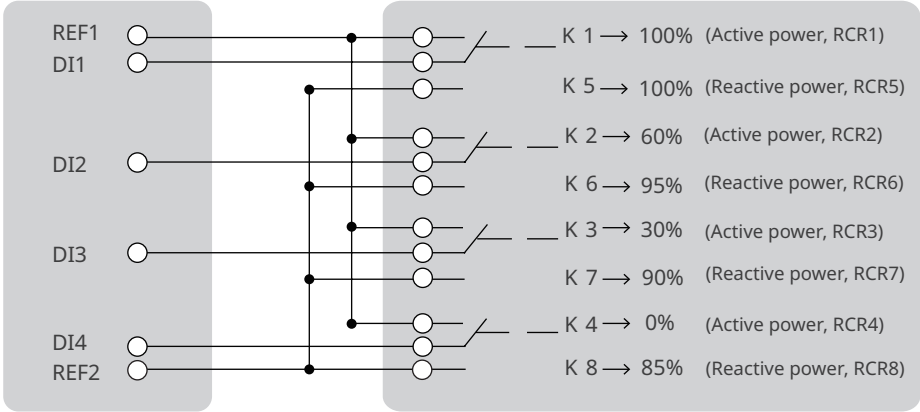

Step 1 Tap **Power Control > RCR**.

Step 2 Enable or disable RCR based on actual needs.

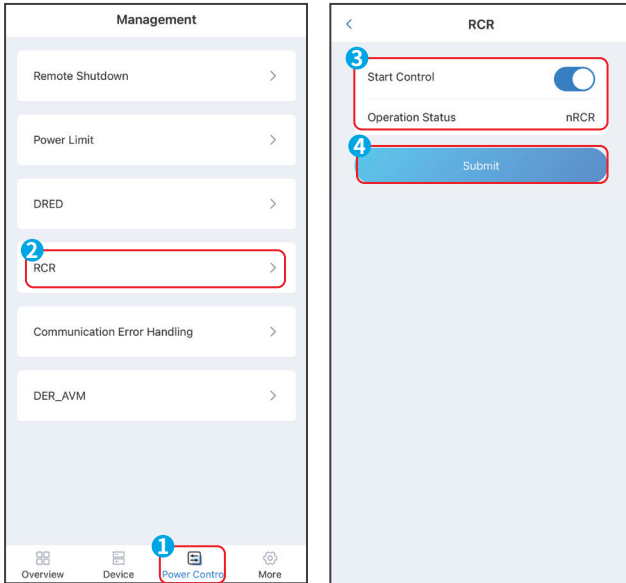

Parameter	Description
Start Control	Enable or disable RCR.
Operation Status	<ul style="list-style-type: none"> • The connection status of the device, including: nRCR, RCR1, RCR2, RCR3, RCR4, RCR5, RCR6, RCR7, RCR8. • nRCR: neither active power derating nor reactive power compensation is conducted.

8.3.7.5 Setting Communication Error Handling

Step 1 Tap **Power Control > Communication Error Handling**.

Step 2 Set the handling method when the communication between the EzLogger and the inverter or the smart meter is abnormal.

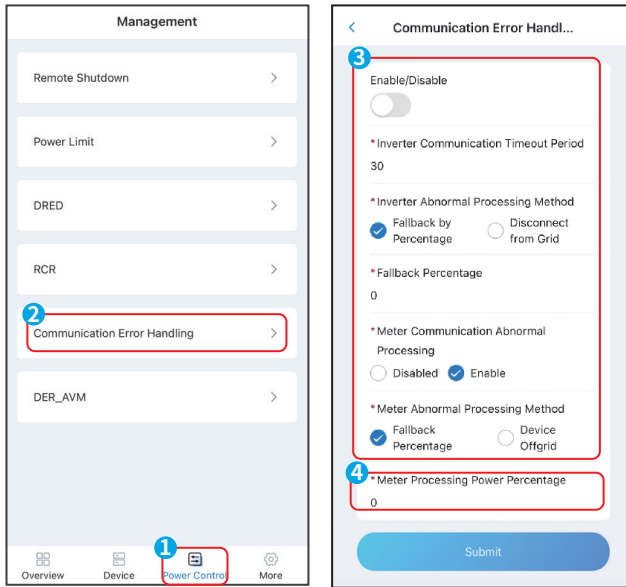

Parameter	Description
Enable/Disable	Enable Communication Error Handling, protective measures will be taken when the communication between the inverter and the EzLogger or the smart meter is abnormal.
Inverter Communication Timeout Period	The protective measures will be taken when the communication exception time exceeds the set time.
Inverter Abnormal Process Method	The following measures can be taken when the communication between the inverter and the EzLogger is abnormal: <ul style="list-style-type: none"> • Fallback by Percentage: the equipment continues to work at the percentage of the rated power. • Device Offgrid: stop the equipment.
Meter Communication Abnormal Processing	Enable Meter Communication Abnormal Processing, protective measures will be taken when the communication between the smart meter and the EzLogger is abnormal.
Meter Abnormal Processing Method	The following measures will be taken when the smart meter communication is abnormal. <ul style="list-style-type: none"> • Fallback by Percentage: the equipment continues to work at the percentage of the rated power. • Device Offline: stop the equipment.
Meter Processing Power Percentage	The equipment works at the percentage of the rated power.

8.3.7.6 Setting DER_AVM

- The standards of Korea and other regions require that the inverters must provide a signal controlling port for DER_AVM, which can be used for grid scheduling.
- To realize DER_AVM, connect a third party KDN device to **RS485-4** of the EzLogger.

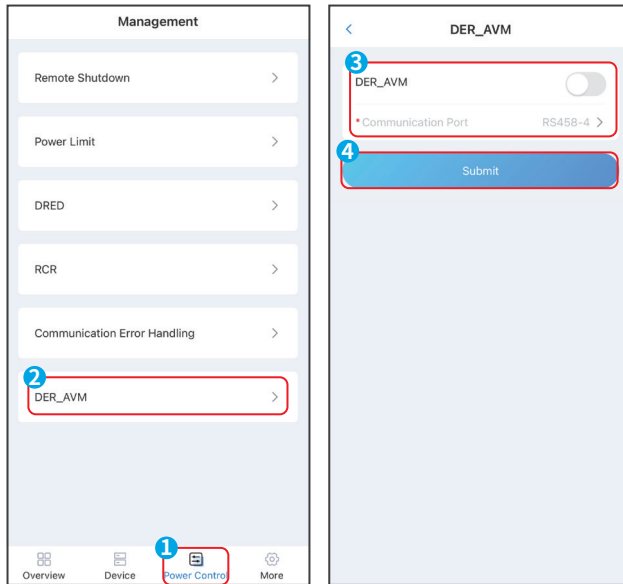

Parameter	Description
Start Control	Enable or disable DER_AVM.
Communication Port	Port for connecting the KDN device and the EzLogger. The default port is RS485-4.

8.3.8 Setting Network Parameters

8.3.8.1 Configure LAN Parameters

NOTICE

The default network parameters will be displayed based on actual settings. Configure the parameters according to actual needs if necessary.

Step 1 Tap **More > Internet Setting > LAN Configuration**.

Step 2 Set the LAN parameters based on actual needs.

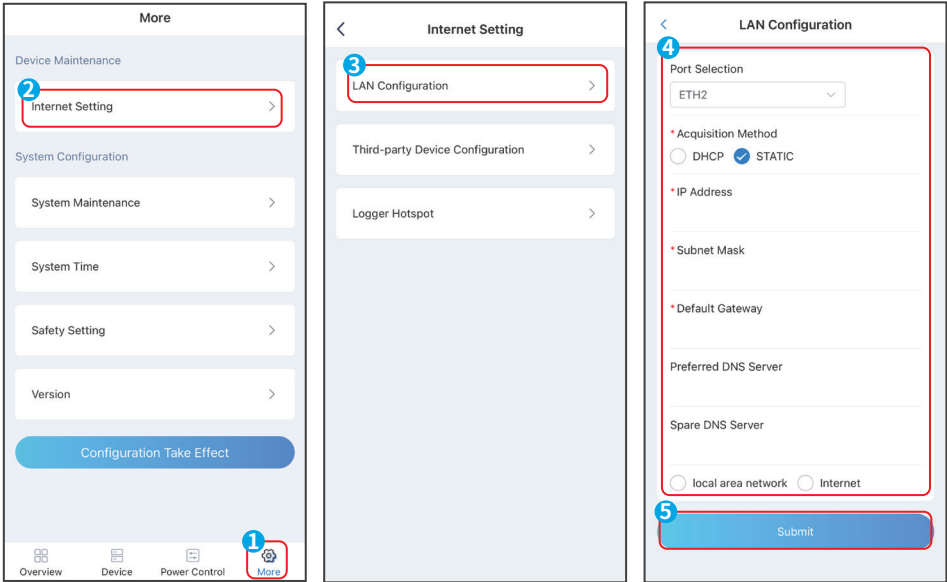

Parameter	Description
Port Selection	Select the connected network port of the EzLogger. Supported: ETH1 or ETH2.
Acquisition Method	<ul style="list-style-type: none"> Manually set the fixed network parameters based on actual situation when selecting STATIC mode. The IP address can be obtained automatically when selecting DHCP mode.
IP Address	Set the IP address of the EzLogger. Set the IP address on the same network segment as the router IP address, and based on the power plant planning. If the IP address is modified, log in with the new IP address.
Subnet Mask	Set the subnet mask of the EzLogger. Set the parameter based on the actual subnet mask of the router connected to the EzLogger.
Default Gateway	Set the default gateway of the EzLogger. Set the parameter based on the actual gateway of the router connected to the EzLogger.
Preferred DNS Server	Set the parameter as the IP address of the LAN's router when connecting to a public network, for example, connecting to GoodWe server, using a domain name for the server address.

Parameter	Description
Spare DNS Server	Ignore this parameter in common situations. When the preferred DNS server fails to resolve a domain name, use the alternate DNS server.
Local area network/Internet	Select Internet to connect to the server and transfer data to the cloud.

8.3.8.2 Setting RS485 Parameters

NOTICE

Set the RS485 parameters when the EzLogger connects to a third-party device, such as a MV station or a environmental monitoring instrument.

Step 1 Tap **More > Internet Setting > Third-party Device Configuration**.

Step 2 Set the RS485 parameters based on actual needs.

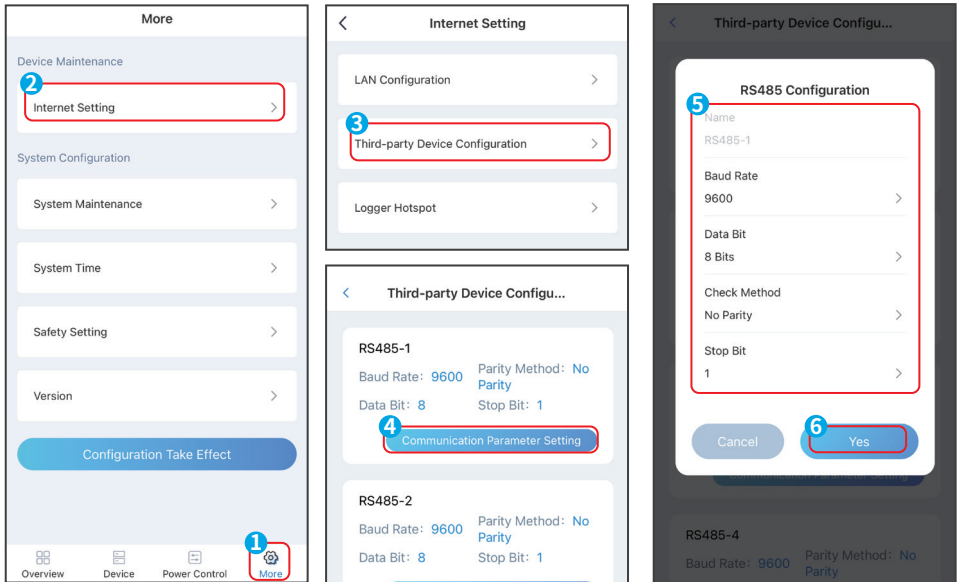

Parameter	Description
Name	Select the actual connected RS485 port of the device.
Baud Rate	Set according to the baud rate of the connected equipment. Supported baud rate: 300, 1200, 2400, 4800, 9600, 19200.
Data Bit	Supported value: 7 bits or 8 bits.
Parity Method	Set according to the parity check method of the connected equipment. Supported values: No Parity, Odd Parity, Even Parity, 1 Parity, or 0 Parity.
Stop Bit	Set according to the stop bit of the connected equipment. Supported values: 1, 1.5, and 2.

8.3.8.3 Setting the Logger Hotspot Parameters

NOTICE

- The EzLogger provides a WiFi hotspot signal for local configuration. After connecting to the WiFi hotspot signal, you can commission the device through the web page or SolarGo App.
- The SSID and password of the hotspot can be changed. After the change, log in to the web or App again using the new SSID and password.

Step 1 Tap **More > Internet Setting > Logger Hotspot**.

Step 2 Modify the hotspot SSID and password based on actual needs.

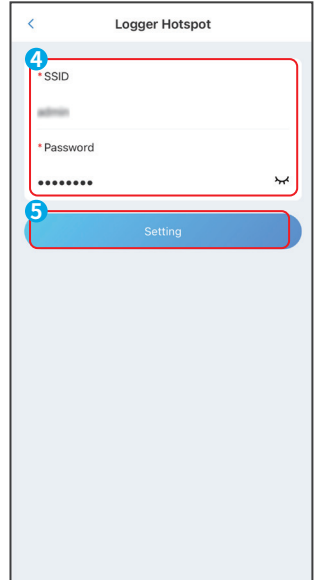
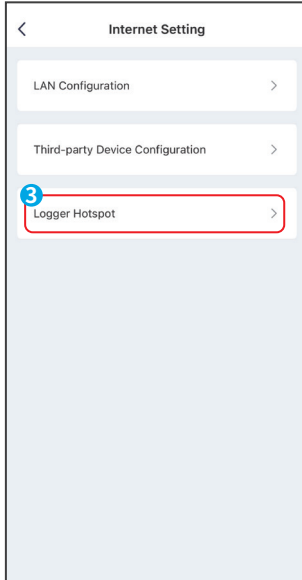
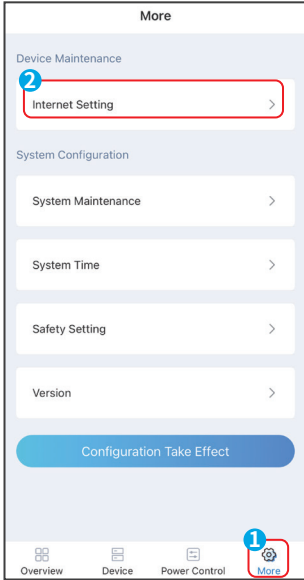

Parameter	Description
SSID	Hotspot signal name of the EzLogger. Default name: Log-***.
Password	Hotspot password of the EzLogger. Default password: 12345678.

8.3.8.4 Setting the 4G Parameters

NOTICE

- 4G is available in some countries and regions. Contact local distributors for more details.
- Disconnect the network cable between the EzLogger and the router after enabling 4G communication. Otherwise, the communication may fail.

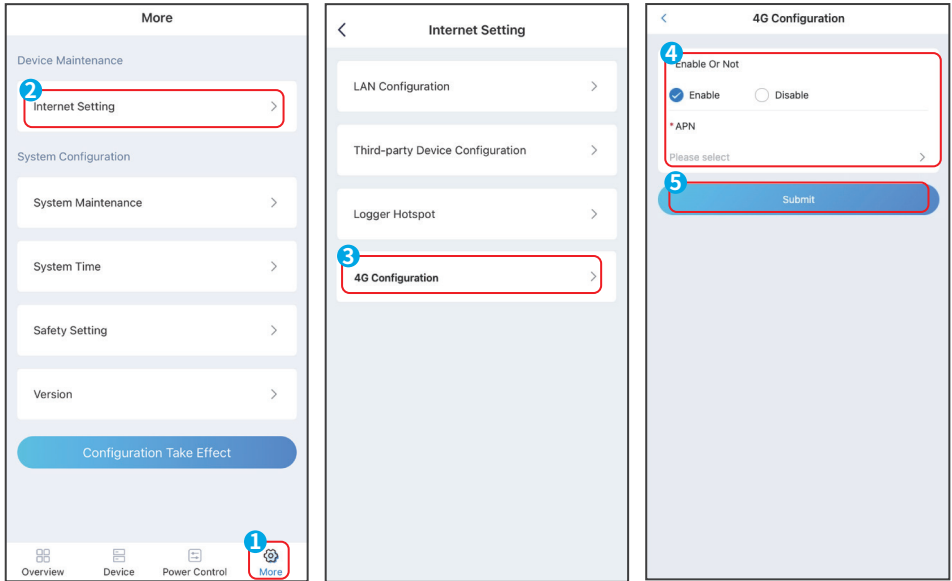

Parameter	Description
Enable Or Not	Enable or disable 4G function. Applicable only when the EzLogger accesses the system over the 4G network.
APN	Select the operator based on actual situation.

9 Maintenance

9.1 Routine Maintenance

DANGER

Power off the EzLogger before operations and maintenance. Otherwise, the EzLogger may be damaged or electric shocks may occur.

Maintaining Item	Maintaining Method	Maintaining Period
Electrical connection	Check whether the cables are securely connected. Check whether the cables are broken or whether there is any exposed copper core.	Once 6 months or once a year
Environmental inspection	Check whether there is any high electromagnetic interference devices or heat sources around the EzLogger.	Once 6 months or once a year

9.2 System Maintenance (WEB)

9.2.1 Upgrading

NOTICE

Ensure that the EzLogger is powered on during the upgrade, otherwise, the upgrade may fail.

- During upgrade, the web will turn to log in page automatically. Do not log in during the upgrade period.
- It takes about 10min for upgrading.

Upgrading via USB flash drive (only for EzLogger)

Step 1 Obtain the upgrading package from after-sales service and prepare a FAT32 USB flash drive ($\leq 32G$).

Step 2 Create a new folder named **collector** in the root directory of the USB flash drive. Put the upgrade folder into the collector folder.

Step 3 Insert the USB flash drive into the USB port of the EzLogger. The fault indicator turns to fast blinking after the EzLogger detects the update package and starts upgrading. If the fault indicator does not blink fast, check whether the upgrade package and USB flash drive are in proper state.

Step 4 The EzLogger will restart automatically after upgrading.

Upgrading via web

Step 1 Obtain the upgrading package from after-sales service.

Step 2 Save the upgrade package to the PC and upgrade the device as following.

Upgrade the EzLogger

1 Device Maintenance

2 Device Upgrade

3 Data Logger

4 Select Firmware Package

5 Start Upgrading

6 Start Upgrading

Number	Device SN	Current Version
1		

Tick the device to be upgrade.

Upgrade the inverter

1 Device Maintenance

2 Device Upgrade

3 Inverter

4 Device Type

5 Firmware Type

6 Import Firmware Package

7 Firmware Package Selection

8 Start Upgrading

9 Start Upgrading

Number	Device Subtype	Device SN	Current ARM Version	Current ARM Transmission Progress	Status
1					

Tick the device to be upgrade.

9.2.2 Maintaining the System

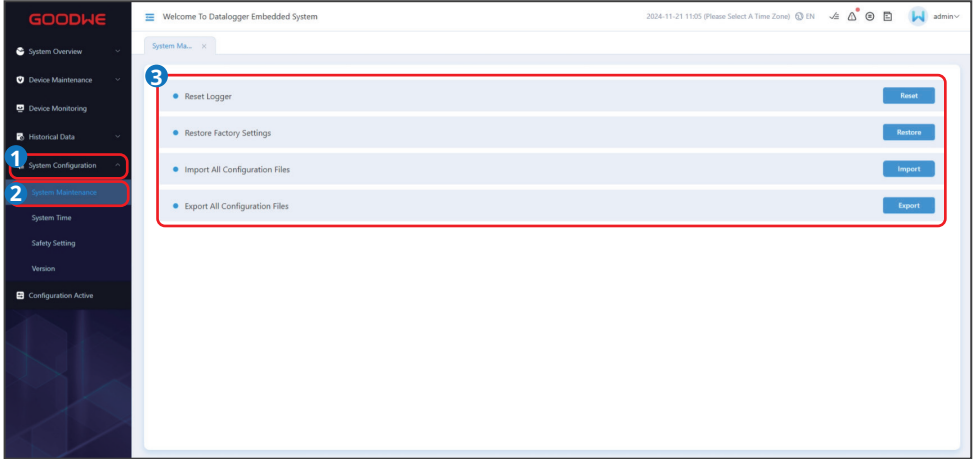

Parameter	Description
Reset Logger	Perform a system reset, and the EzLogger will automatically shut down and restart.
Restore Factory Settings	<ul style="list-style-type: none"> Restore Factory Settings: clear device access information, forwarding information, login password. Communication Configuration: restore network settings. Data Collection: clear logs, historical alarms, historical data.
Import All Configuration Files	Before replacing the EzLogger, export the configuration file to the local storage.
Export All Configuration Files	After replacing the EzLogger, import the previously exported configuration file from the local storage to the new EzLogger. Once the import is successful, the EzLogger will restart, and the configuration file will take effect. Confirm that the device parameters are correctly configured.

9.2.3 Set System Time

NOTICE

Modifying the date and time will affect the integrity of the system's power generation and performance data records. Please refrain from changing the time zone and system time arbitrarily.

Step 1 Set the system time as following.

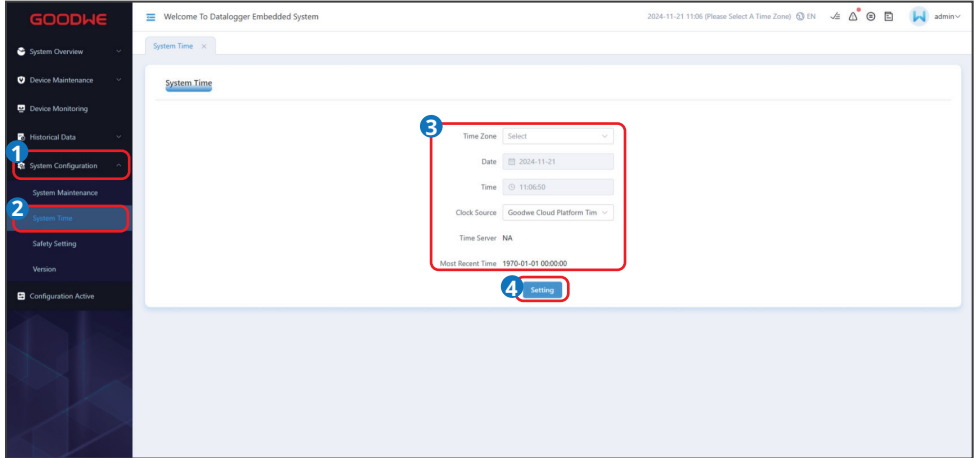

Parameter	Description
Time Zone	The parameters can be modified when Management System is selected as Clock Source .
Date	
Time	
Clock Source	Set the clock source. Supported: NTP, IEC104, Modbus-TCP, Management System, Goodwe Cloud Platform Time Synchronization.

9.2.4 Change Login Password

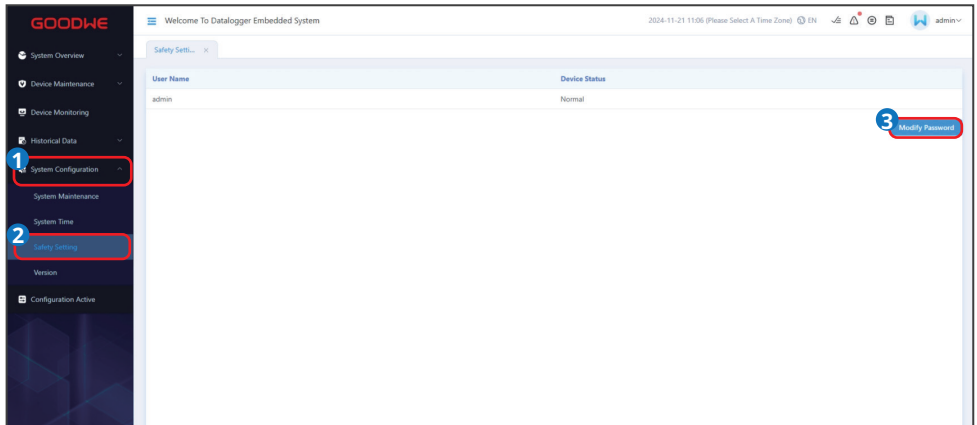

9.3 System Maintenance (App)

9.3.1 System

Step 1 Tap **More** > **System Maintenance**.

Step 2 Reset the EzLogger or restore factory settings based on actual needs.

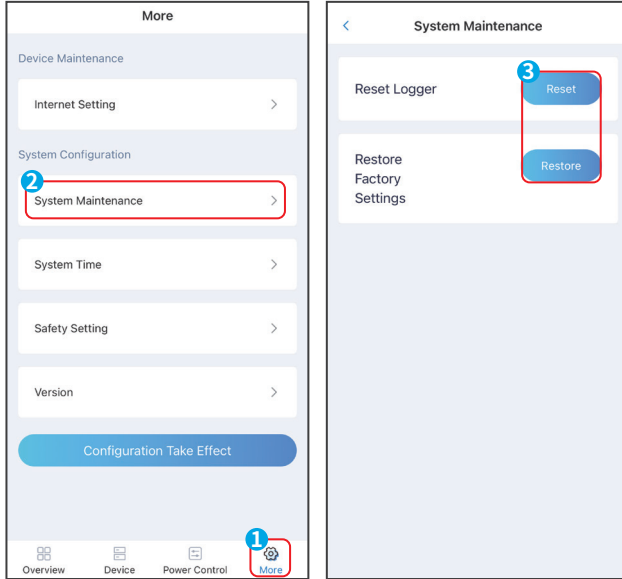

Parameter	Description
Reset Logger	Perform a system reset, and the EzLogger will automatically shut down and restart.
Restore Factory Settings	<ul style="list-style-type: none"> • Restore Factory Settings: clear device access information, forwarding information, login password. • Communication Configuration: restore network settings. • Data Collection: clear logs, historical alarms, historical data.

9.3.2 Setting System Time

NOTICE

Modifying the date and time will affect the integrity of the system's power generation and performance data records. Please refrain from changing the time zone and system time arbitrarily.

Step 1 Tap **More** > **System Time**.

Step 2 Select the **Clock Source** and set the time based on actual needs.

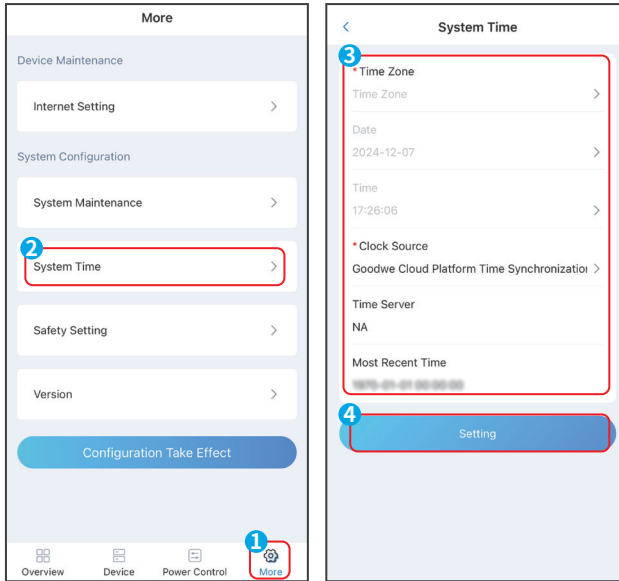

Parameter	Description
Time Zone	The parameters can be modified when Management System is selected as Clock Source .
Date	
Time	
Clock Source	Se the clock source. Supported: NTP, IEC104, Modbus-TCP, Management System, Goodwe Cloud Platform Time Synchronization.

9.3.3 Change Login Password

Step 1 Tap **More > Safety Setting**.

Step 2 Tap **Modify Password** and set the new password.

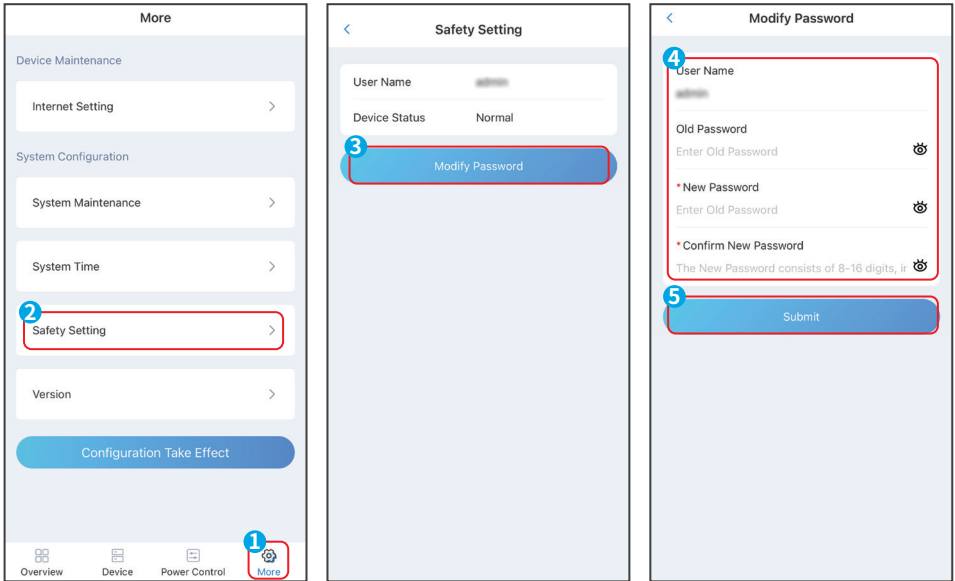

9.3.4 Check EzLogger Version

Step 1 Tap **More > Version** to view the current versions of the EzLogger.

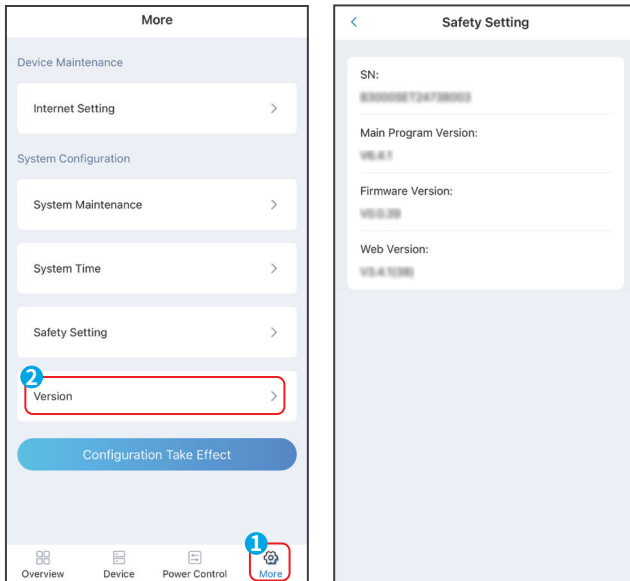

9.4 Power Off

DANGER

- Power off the EzLogger before operations and maintenance. Otherwise, the EzLogger may be damaged or electric shocks may occur.

Step 1 Disconnect the power adapter from the AC socket.

Step 2 Disconnect the power adapter from the EzLogger.

9.5 Removing the EzLogger

WARNING

- Make sure that the EzLogger is powered off.
- Wear proper personal protective equipment before any operations.

Step 1 Disconnect all electrical connections of the equipment, including the power cable and communication cables.

Step 2 Remove the equipment.

Step 3 Store the equipment properly. If the equipment will be used again in the future, ensure that the storage conditions meet the requirements.

9.6 Disposing of the EzLogger

If the equipment cannot work any more, dispose of it according to the local disposal requirements for electrical equipment waste. Do not dispose of it as household waste.

9.7 Troubleshooting

Perform troubleshooting according to the following methods. Contact the after-sales service if these methods do not work.

Collect the information below before contacting the after-sales service, so that the problems can be solved quickly.

1. Equipment information like serial number, software version, installation date, fault time, fault frequency, etc.
2. Installation environment. It is recommended to provide some photos and videos to assist in analyzing the problem.
3. Utility grid situation.

No.	Fault	Cause	Solutions
1	The equipment is not able to be powered on.	<ol style="list-style-type: none"> 1. Cable of the power adapter is improperly connected to the EzLogger. 2. The power adapter is improperly connected to the socket. 3. Power adapter malfunction. 4. Equipment malfunction. 	<ol style="list-style-type: none"> 1. Check whether the power adapter is properly connected to the EzLogger. 2. Check whether the power adapter is properly connected to the socket. 3. Replace the power adapter. 4. Contact your distributor or after-sales service center.
2	Fail to log into the web over LAN.	<ol style="list-style-type: none"> 1. The operating system or browser version is lower than required. 2. The network cable is connected to an incorrect port. 3. Incorrect IP address. 4. Incorrect web login address. 5. Browser exception. 6. Equipment malfunction. 	<ol style="list-style-type: none"> 1. Recommended operating system: Windows 7 or later. Recommended browser: Chrome52, Firefox58, or later version. 2. Check whether the network cable is connected to ETH2 port of the EzLogger when logging using the default IP. 3. Check whether the IP address of the EzLogger and the PC are on the same network segment. 4. Enter http://XX.XX.XX.XX or https://XX.XX.XX.XX:443 in the address bar of the web. XX.XX.XX.XX is the IP address of the EzLogger. 5. Clear browser history data or cache. 6. Contact your distributor or after-sales service center.

No.	Fault	Cause	Solutions
3	Fail to log into the web over WiFi.	<ol style="list-style-type: none"> 1. The operating system or browser version is lower than required. 2. The WiFi signal is too weak. 3. Incorrect web login address. 4. Browser exception. 5. Equipment malfunction. 	<ol style="list-style-type: none"> 1. Recommended operating system: Windows 7 or later. Recommended browser: Chrome52, Firefox58, or later version. 2. If there is no obstacles, the recommended distance between the PC or mobile phone and the EzLogger is 15m. Check if the distance is too far. 3. Enter http://XX.XX.XX.XX or https://XX.XX.XX.XX:443 in the address bar of the web. XX.XX.XX.XX is the IP address of the EzLogger. 4. Clear browser history data or cache. 5. Contact your distributor or after-sales service center.
4	Fail to connect to the WiFi hotspot of the EzLogger.	<ol style="list-style-type: none"> 1. The WiFi hotspot of the EzLogger is disabled. 2. The WiFi antenna is not installed or installed in an improper way. 3. The distance between the EzLogger and the PC exceeds the allowed WiFi communication distance. 4. Equipment malfunction. 	<ol style="list-style-type: none"> 1. Log into the web over LAN to enable WiFi hotspot and reconnect to the WiFi hotspot. 2. Check whether the included WiFi antenna is installed properly. 3. If there is no obstacles, the recommended distance between the PC or mobile phone and the EzLogger is 15m. Check if the distance is too far. 4. Contact your distributor or after-sales service center.
5	Cannot search the devices automatically.	<ol style="list-style-type: none"> 1. Automatic search applies only to the first networking. 2. The inverter is powered off. 3. The RS485 cables are connected in a wrong way, like reverse connection, missing connection, loose connection. 4. Equipment malfunction. 	<ol style="list-style-type: none"> 1. Add devices through Device Access if more devices are required. 2. Check whether the inverter is powered on. 3. Check whether the RS485 cables are connected properly. 4. Contact your distributor or after-sales service center.
6	The data cannot be uploaded to the server over LAN.	<ol style="list-style-type: none"> 1. The router or Ethernet switch connected to the EzLogger cannot access the Internet. 2. Incorrect parameters, like Acquisition Method, IP Address, etc.. 3. Equipment malfunction. 	<ol style="list-style-type: none"> 1. Check the working status of the router or the Ethernet switch. 2. Check the network parameters. 3. Contact your distributor or after-sales service center.

No.	Fault	Cause	Solutions
7	The data cannot be uploaded to the server over 4G.	<ol style="list-style-type: none"> 1. The 4G antenna is not installed or installed in an improper way. 2. The SIM card is improperly inserted or has no data for Internet. 3. 4G is disabled. 4. The network cable between the EzLogger and the router is connected. 5. Equipment malfunction. 	<ol style="list-style-type: none"> 1. Check whether the included 4G antenna is installed properly. 2. Check whether the SIM card is intact and has enough data. 3. Enable 4G on the web page. 4. Disconnect the network cable between the EzLogger and the router. 5. Contact your distributor or after-sales service center.
8	Cannot upgrade the EzLogger via USB flash drive.	<ol style="list-style-type: none"> 1. Incorrect USB format. 2. The upgrade package is not stored in the specific directory. 3. Equipment malfunction. 	<ol style="list-style-type: none"> 1. Check whether the USB flash drive is an FAT32 USB. 2. Create a new folder named collector in the root directory of the USB flash drive. Put the upgrade folder into the collector folder. 3. Contact your distributor or after-sales service center.
9	Cannot upgrade the inverter via web.	<ol style="list-style-type: none"> 1. The inverter does not support remote upgrade. 2. Incorrect or damaged upgrade package. 3. The upgrade package does not match the inverter version. 4. Improper connection of RS485 communication cables. 5. Equipment malfunction. 	<ol style="list-style-type: none"> 1. Check whether the inverter supports remote upgrade. 2. Contact your distributor or after-sales service center for correct upgrade package. 3. Check whether the RS485 cables are properly connected. 4. Contact your distributor or after-sales service center.
10	Power limit exception	<ol style="list-style-type: none"> 1. The RS485 cables between the EzLogger and the inverter or smart meter are improperly connected. 2. The power limit function is disabled or enabled but not take effect. 3. The inverter does not support power limit. 4. Equipment malfunction. 	<ol style="list-style-type: none"> 1. Check whether the RS485 cables are properly connected. 2. Check whether the power limit function is enabled on web page. 3. Contact your distributor or after-sales service center to check whether the inverter supports power limit.
11	Remote shutdown or OVGR&RPR fails.	<ol style="list-style-type: none"> 1. The RS485 cables between the EzLogger and the inverter are improperly connected. 2. The remote shutdown device or OVGR&RPR is connected improperly. 3. Incorrect web configuration. 4. Equipment malfunction. 	<ol style="list-style-type: none"> 1. Check whether the RS485 cables are properly connected. 2. Check whether the external protective device is connected properly. 3. Check whether the parameters are correct. 4. Contact your distributor or after-sales service center.

No.	Fault	Cause	Solutions
12	DRED/RCR fails.	<ol style="list-style-type: none"> 1. The RS485 cables between the EzLogger and the inverter are improperly connected. 2. The DRED or RCR is connected improperly. 3. DRED/RCR is disabled. 4. Equipment malfunction. 	<ol style="list-style-type: none"> 1. Check whether the RS485 cables are properly connected. 2. Check whether the external protective device is connected properly. 3. Enable DRED/RCR on the web page. 4. Contact your distributor or after-sales service center.
13	The EzLogger fails forwarding parameters over IEC104, Modbus-TCP, IEEE2030.5, FTP, or Email.	<ol style="list-style-type: none"> 1. Communication between the EzLogger and management platform fails. 2. Incorrect forwarding settings. 3. Equipment malfunction. 4. Third party monitoring is not supported by the inverter . 	<ol style="list-style-type: none"> 1. Check whether the network between the EzLogger and the management platform is normal. 2. Check whether the forwarding parameters are correct. 3. Contact your distributor or after-sales service center.
14	The terminal address cannot be set after searching the device	The inverter ARM version is too low.	Contact your distributor or after-sales service center.

10 Technical Parameters

Technical Parameters	EzLogger3000C
Device Management	
Max. Number of Connected Devices	100
Max. Number of Connected Devices 100	
Power Adapter	AC Input: 100~240V, 50/60Hz DC Output: 24V
DC Power Supply (V)	24
Power Consumption (W)	<15
Communication Interface	
LAN	2
RS485	COM×4
WIFI(local maintenance)	802.11 b/g/n, 2.412GHz-2.484GHz
4G	Optional
Digital/Analog Input/Output	DI×4, DO×2, AI×4
PT100/PT1000	PT100×1, PT1000×1
DC Output Power	12V, 100mA
Communication Protocol	
Ethernet	Modbus-TCP, IEC 60870-5-104
RS485	Modbus-RTU, IEC 60870-5-103 (standard), DL/T645
User Interface	
LED	LED×4
WEB	Embedded Web
USB	USB 2.0 x 1
Mechanical	
Dimensions (W×H×D mm)	255*47.5*173
Weight (kg)	0.8
Installation Method	Wall Mounting, DIN Rail Mounting, Tabletop Mounting
Environment	
Operating Temperature Range (°C)	-30~+60
Storage Temperature Range (°C)	-40~+70
Relative Humidity	5~95%
Max. Operating Altitude (m)	5000
Ingress Protection Rating	IP20

11 Appendix

11.1 FAQ

11.1.1 How to configure power limit parameters?

Prerequisites:

- Refer to the user manual of the devices to install and power on the inverters, EzLoggers, and smart meters properly.
- Refer to section **8.2.2 Log In** to log in to the web.
- Ensure that the system networking is successful and all inverters are online.

Step 1 Click **Device Maintenance > Device Access > Automatic Search** in the homepage of the web to add devices.

Step 2 (Optional) If the smart meter is a third part meter, go to the device access page and click **Manually Add**.

Step 3 (Optional) Select **Device Type** as **Smart Meter** and set the parameters based on actual information. Click **Confirm** to complete the settings.

Step 4 Click **Configuration Active** and **Take Effect** to finish adding the inverter and smart meter.

Step 5 Click **Device Maintenance > Power Control > Power Limit**.

Step 6 Set the parameters based on actual needs as the interface promoted.

Refer to section **8.2.4 Adding Devices** if you have any questions about adding an inverter or a smart meter. Refer to section **8.2.11 Setting Power Adjustment Parameters** if you have any questions about setting power limit parameters.

11.1.2 How to set IEC104 forwarding parameters?

Prerequisites:

- Refer to the user manual of the devices to install and power on the inverters, EzLoggers, and smart meters properly.
- Refer to section **8.2.2 Log In** to log in to the web.
- Ensure that the system networking is successful and all inverters are online.

Step 1 Click **Device Maintenance > Network Setting** in the homepage of the web to set the network parameters.

Step 2 Click the **LAN** tab, set the **Acquisition Method** to **STATIC**, select **Local Area Network**, and set the IP based on actual information.

Step 3 Click **Device Maintenance > Third-Parties Setting > IEC104** in the homepage of the web.

Step 4 Click **Add Channel** and set the channel parameters based on actual situation. Click **Confirm** to complete the settings.

Step 5 Click **Configuration Active** and **Take Effect** to finish configuring the forwarding parameters.

Step 6 Commission the third-party platform according to actual demands to establish the connection between the EzLogger and the platform.

Refer to section **8.2.9 Setting Third Party Parameters** if you have any questions about setting forwarding parameters.

11.1.3 How to set Modbus-TCP forwarding parameters

Prerequisites:

- Refer to the user manual of the devices to install and power on the inverters, EzLoggers, and smart meters properly.
- Refer to section **8.3 Log In** to log in to the web.
- Ensure that the system networking is successful and all inverters are online.

Step 1 Click **Device Maintenance** > **Network Setting** in the homepage of the web to set the network parameters.

Step 2 Click the **LAN** tab, set the **Acquisition Method** to **STATIC**, select **Local Area Network**, and set the IP based on actual information.

Step 3 Click **Device Maintenance** > **Third-Parties Setting** > **Modbus-TCP** in the homepage of the web.

Step 4 Click **Add Channel** and set the channel parameters based on actual situation. Click **Confirm** to complete the settings.

Step 5 Click **Configuration Active** and **Take Effect** to finish configuring the forwarding parameters.

Step 6 Commission the third-party platform according to actual demands to establish the connection between the EzLogger and the platform.

Refer to section **8.2.9 Setting Third Party Parameters** if you have any questions about setting forwarding parameters.

11.1.4 How to Export 104 Point Table

Step 1 Click **Device Monitoring** to enter the monitoring page.

Step 2 Click **IEC104 > Export 104 Point Table**.

Step 3 The exported 104 forwarding table is found in the browser download contents. The required data can be queried by searching for the inverter serial number.

11.1.5 How To Add New Device After Automatic Searching

NOTICE

If a scenario other than the following occurs, it is recommended to reset the EzLogger or contact the after-sales service center.

Scenario 1: Maintain existing devices and the configuration is not effected.

Web

Step 1 Click **Automatic Search > Start Search** in the device access interface, and complete searching following prompts.

Step 2 After searching for new devices, tick new devices and assign the address with one click or manually enter the terminal address according to the actual demand.

Step 3 Complete configuration according to the interface prompts. Go to the device access page and check the networking information.

App

Step 1 Tap **Device > Networking Settings > Start Searching** and complete searching following prompts.

Step 2 After searching for new devices, assign the address with one click or manually enter the terminal address according to the actual demand.

Step 3 Complete configuration according to the interface prompts. Go to the device page and check the networking information.

Scenario 2: Maintain existing devices and the configuration is effected.

Web

Step 1 Click **Automatic Search > Re-networking** in the device access interface, and complete searching following prompts.

Step 2 After searching for new devices, tick new devices and assign the address with one click or manually enter the terminal address according to the actual demand.

Step 3 Complete configuration according to the interface prompts. Go to the device access page and check the networking information.

App

Step 1 Tap **Device > Networking Settings > Re-networking** and complete searching following prompts.

Step 2 After searching for new devices, assign the address with one click or manually enter the terminal address according to the actual demand.

Step 3 Complete configuration according to the interface prompts. Go to the device page and check the networking information.

Scenario 3: Modify existing devices and the configuration is not effected.

Web

Step 1 Click **Automatic Search > Delete History** in the device access interface.

Step 2 Wait for 10 mins or restart the inverters. Click **Automatic Search > Start Searching** and complete searching following prompts.

Step 3 Complete configuration according to the interface prompts. Go to the device access page and check the networking information.

App

Step 1 Tap **Device > Networking Settings > ... > Delete History**.

Step 2 Wait for 10 mins or restart the inverters. Click **Automatic Search > Start Searching** and complete searching following prompts.

Step 3 Complete configuration according to the interface prompts. Go to the device page and check the networking information.

Scenario 4: Modify existing devices and the configuration is effected.

Web

Step 1 Click **Automatic Search > Re-networking** in the device access interface, and complete searching following prompts.

Step 2 After searching for new devices, tick new devices and assign the address with one click or manually enter the terminal address according to the actual demand.

Step 3 Complete configuration according to the interface prompts. Go to the device access page and check the networking information.

App

Step 1 Tap **Device > Networking Settings > Re-networking** and complete searching following prompts.

Step 2 After searching for new devices, assign the address with one click or manually enter the terminal address according to the actual demand.

Step 3 Complete configuration according to the interface prompts. Go to the device page and check the networking information.



Official
website

GoodWe Technologies Co., Ltd.

 No. 90 Zijin Rd., New District, Suzhou, 215011, China

 www.goodwe.com

 service@goodwe.com