

# GOODWE



## User Manual

**Hybrid Inverter**

ETC Series

50kW&100kW

**AC-Coupled Inverter**

BTC Series

50kW&100kW

V1.2 -2024 -10-30

**Trademarks**

**GOODWE** and other GOODWE trademarks are trademarks of GoodWe Technologies Co.,Ltd. All other trademarks or registered trademarks mentioned in this manual are owned by the company.

**NOTICE**

The information in this user manual is subject to change due to product updates or other reasons. This manual cannot replace the safety instructions or labels on the equipment unless otherwise specified. All descriptions in the manual are for guidance only.

# CONTENT

<b>1</b>	<b>About This Manual .....</b>	<b>1</b>
1.1	Applicable Model .....	1
1.2	Target Audience .....	1
1.3	Symbol Definition .....	2
<b>2</b>	<b>Safety Precaution .....</b>	<b>3</b>
2.1	General Safety .....	3
2.2	PV String Safety .....	3
2.3	Inverter Safety .....	4
2.4	Battery Safety .....	5
2.5	Personnel requirements .....	5
2.6	EU Declaration of Conformity .....	5
<b>3</b>	<b>Product Introduction .....</b>	<b>6</b>
3.1	Product Introduction .....	6
3.2	Application Scenarios .....	7
3.3	Working Mode .....	12
3.3.1	System Working Mode .....	12
3.3.2	Inverter operation mode .....	16
3.4	Features .....	17
3.5	Appearance .....	18
3.5.1	Parts .....	18
3.5.2	Dimension .....	20
3.5.3	Indicator Description .....	20
3.5.4	Nameplate .....	21
<b>4</b>	<b>Check and Storage .....</b>	<b>22</b>
4.1	Check Before Receiving .....	22
4.2	Deliverables .....	22
4.3	Storage .....	23
<b>5</b>	<b>Installation .....</b>	<b>24</b>
5.1	Installation Requirements .....	24
5.2	Inverter Installation .....	26
5.2.1	Moving the Inverter .....	26
5.2.2	Installing the Inverter .....	26
<b>6</b>	<b>Electrical Connection .....</b>	<b>28</b>
6.1	Safety Precaution .....	28
6.2	System Wiring Diagram .....	30
6.3	Opening the Door of the Wiring Compartment .....	32
6.4	Connecting the PE cable .....	33

6.5	Connecting AC Output Cable, Load Output Cable, Battery Cable, and PV Input Cable....	33
6.6	Communication .....	37
6.6.1	Communication Port Introduction.....	37
6.6.2	Connecting the Communication Cable.....	39
6.6.3	Equip communication cable with magnetic ring(optional).....	39
6.5	Closing the Door of the Wiring Compartment .....	40
<b>7</b>	<b>Equipment Commissioning.....</b>	<b>41</b>
7.1	Check Before Power ON.....	41
7.2	Power On .....	41
<b>8</b>	<b>System Commissioning .....</b>	<b>42</b>
8.1	Indicators and Buttons .....	42
8.2	Setting Inverter Parameters via LCD.....	42
8.3	Setting Inverter Parameters via SolarGo App.....	45
8.4	Monitoring via SEMS Portal.....	45
<b>9</b>	<b>Maintenance.....</b>	<b>46</b>
9.1	Power OFF the Inverter.....	46
9.2	Removing the Inverter .....	46
9.3	Disposing of the Inverter.....	46
9.4	Troubleshooting.....	46
9.5	Routine Maintenance .....	59
<b>10</b>	<b>Technical Parameters .....</b>	<b>60</b>
<b>11</b>	<b>Appendix .....</b>	<b>64</b>

# 1 About This Manual

This manual describes the product information, installation, electrical connection, commissioning, troubleshooting, and maintenance. Read through this manual before installing and operating the product. All the installers and users have to be familiar with the product features, functions, and safety precautions. This manual is subject to update without notice. For more product details and latest documents, visit <https://en.goodwe.com>.

## 1.1 Applicable Model

This manual applies to the listed inverters below:

### ETC Series (Hybrid Inverter)

- GW50K06-ETC
- GW50K07-ETC
- GW100K06-ETC
- GW100K07-ETC

### BTC Series (AC-Coupled Inverter)





- GW50K06-BTC
- GW50K07-BTC
- GW100K06-BTC
- GW100K07-BTC

## 1.2 Target Audience

This manual applies to trained and knowledgeable technical professionals. The technical personnel has to be familiar with the product, local standards, and electric systems.

## 1.3 Symbol Definition

Different levels of warning messages in this manual are defined as follows:

Indicates a high-level hazard that, if not avoided, will result in death or serious injury.

Indicates a medium-level hazard that, if not avoided, could result in death or serious injury.

Indicates a low-level hazard that, if not avoided, could result in minor or moderate injury.

Highlights key information and supplements the texts. Or some skills and methods to solve product-related problems to save time.

## 2 Safety Precaution

Please strictly follow these safety instructions in the user manual during the operation.

### NOTICE

The inverters are designed and tested to strictly comply with related safety rules. Read and follow all the safety instructions and cautions before any operations. Improper operation might cause personal injury or property damage as the inverters are electrical equipment.

### 2.1 General Safety

#### NOTICE

- The information in this user manual is subject to change due to product updates or other reasons. This manual cannot replace the safety instructions or labels on the equipment unless otherwise specified. All descriptions in the manual are for guidance only.
- Before installations, read through the user manual to learn about the product and the precautions.
- All operations should be performed by trained and knowledgeable technicians who are familiar with local standards and safety regulations.
- Use insulating tools and wear personal protective equipment when operating the equipment to ensure personal safety. Wear anti-static gloves, clothes, and wrist strips when touching electronic devices to protect the inverter from damage.
- Strictly follow the installation, operation, and configuration instructions in this user manual. The manufacturer shall not be liable for equipment damage or personal injury if you do not follow the instructions. For more warranty details, please visit <https://en.goodwe.com/warranty>

### 2.2 PV String Safety



#### DANGER

Prepare the PV connectors for connecting the DC input cables according to the recommended specifications. Severe damage might happen if other types of PV connectors are used, which is beyond the manufacturer's liability.



#### WARNING

- Ensure the component frames and the bracket system are securely grounded.
- Ensure the DC cables are connected tightly, securely and correctly.
- Measure the DC cables using a multimeter to avoid reverse polarity connection. Also, the voltage should be under the permissible range.
- Do not connect one PV string to more than one inverter at the same time. Otherwise, the inverter may be damaged.
- The PV modules used with the inverter must have an IEC61730 class A rating.









### 2.3 Inverter Safety

 **WARNING**

- The voltage and frequency at the connecting point should meet the grid connection requirements.
- Additional protective devices like circuit breakers or fuses are recommended on the AC side. Specification of the protective device should be at least 1.25 times the maximum AC output current.
- Make sure that all the grounding cables are tightly connected. When there are multiple inverters, make sure that all the grounding points on the enclosures are equipotential connected.
- You are recommended to use copper cables as AC output cables. Contact the manufacturer if you want to use other cables.
- Do not start the BACK-UP function if the PV system is not configured with batteries. Otherwise, the manufacturer shall not be liable for the related system risks.

 **DANGER**

- All labels and warning marks must be clear and distinct after the installation. Do not block, alter, or damage any label.
- Warning labels on the inverter are as follows:

	<p>HIGH VOLTAGE HAZARD. Disconnect all incoming power and turn off the product before working on it.</p>		<p>Delayed discharge. Wait 5 minutes after power off until the components are completely discharged.</p>
	<p>Read through the user manual before any operations.</p>		<p>Potential risks exist. Wear proper Personnel Protective Equipment before any operations.</p>
	<p>High-temperature hazard. Do not touch the equipment to avoid being hurt.</p>		<p>Grounding point.</p>
	<p>CE Mark</p>		<p>Do not dispose of the inverter as household waste. Discard the product in compliance with local laws and regulations, or send it back to the manufacturer.</p>



## 2.4 Battery Safety

### WARNING

- The battery used with the inverter shall be approved by the inverter manufacturer. The approved battery list can be obtained through the official website.
- Before installations, read through the corresponding battery's user manual to learn about the product and the precautions. Strictly follow its requirements.
- If the battery is discharged completely, please charge it in strict accordance with the corresponding battery's user manual.
- Factors such as: temperature, humidity, weather conditions, etc. may limit the battery's current and affect its load.
- Contact after-sale service immediately if the battery is not able to be started. Otherwise, the battery might be damaged permanently.
- Measure the DC cable using the multimeter to avoid reverse polarity connection. Also, the voltage should be under the permissible range.
- Do not connect one battery pack to more than one inverter at the same time. Otherwise, it may cause damage to the inverter.

## 2.5 Personnel requirements

### NOTICE

- Personnel who install or maintain the equipment must be strictly trained, learn about safety precautions and correct operations.
- Only qualified professionals or trained personnel are allowed to install, operate, maintain, and replace the equipment or parts.

## 2.6 EU Declaration of Conformity

GoodWe Technologies Co., Ltd. hereby declares that the inverter with wireless communication modules sold in the European market meets the requirements of the following directives:

- Radio Equipment Directive 2014/53/EU (RED)
- Restrictions of Hazardous Substances Directive 2011/65/EU and (EU) 2015/863 (RoHS)
- Waste Electrical and Electronic Equipment 2012/19/EU
- Registration, Evaluation, Authorization and Restriction of Chemicals (EC) No 1907/2006 (REACH)

You can download the EU Declaration of Conformity on <https://en.goodwe.com>.

GoodWe Technologies Co., Ltd. hereby declares that the inverter without wireless communication modules sold in the European market meets the requirements of the following directives:

- Electromagnetic compatibility Directive 2014/30/EU (EMC)
- Electrical Apparatus Low Voltage Directive 2014/35/EU (LVD)
- Restrictions of Hazardous Substances Directive 2011/65/EU and (EU) 2015/863 (RoHS)
- Waste Electrical and Electronic Equipment 2012/19/EU
- Registration, Evaluation, Authorization and Restriction of Chemicals (EC) No 1907/2006 (REACH)

You can download the EU Declaration of Conformity on <https://en.goodwe.com>.

## 3 Product Introduction

### 3.1 Product Introduction

#### Intended usage

Inverters control and optimize the power in PV systems through an integrated energy management system. The power generated in the PV system can be used, stored in the battery, output to the utility grid, etc.

#### Model

This manual applies to the listed inverters below:

#### ETC Series (Hybrid Inverter)

- GW50K06-ETC
- GW50K07-ETC
- GW100K06-ETC
- GW100K07-ETC

#### BTC Series (AC-Coupled Inverter)

- GW50K06-BTC
- GW50K07-BTC
- GW100K06-BTC
- GW100K07-BTC

### GW100K07-ETC



No.	Referring to	Description
1	Brand Code	GW: GoodWe
2	Nominal Power	<ul style="list-style-type: none"> <li>• 50K: the nominal power is 50kW.</li> <li>• 100K: the nominal power is 100kW.</li> </ul>
3	Configuration	<ul style="list-style-type: none"> <li>• 06: Without off-grid function.</li> <li>• 07: With off-grid function.</li> </ul>
4	Series Code	<ul style="list-style-type: none"> <li>• ETC: hybrid inverter</li> <li>• BTC: AC-Coupled inverter</li> </ul>

## Supported Grid Types

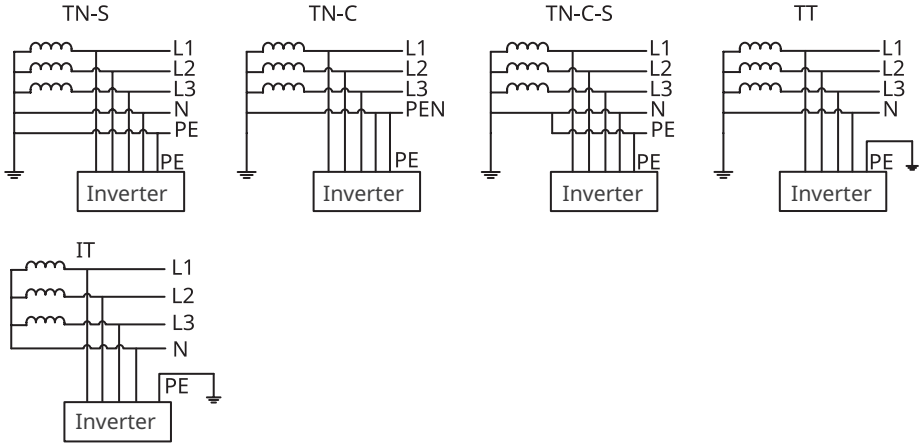

## 3.2 Application Scenarios

### WARNING

- The PV system is not suitable to connect equipment that relies on a stable power supply, such as medical equipment to sustain life. Ensure that no personal injury is occurred when the system is disconnected.
- Avoid loads with high starting current like high-power water pumps in the PV system. Otherwise, the BACK-UP output may fail due to excessive instantaneous power.
- Do not start the BACK-UP function if the PV system is not configured with batteries. Otherwise, the manufacturer shall not be liable for the related system risks.
- Factors such as: temperature, humidity, weather conditions, etc. may limit the battery's current and affect its load.
- The inverter supports UPS, and the switching time is less than 10ms. The UPS function may fail to start if the BACK-UP load capacity exceeds the nominal power of the inverter.
- When single overload protection occurs, the inverter can restart automatically; however, the restarting time will be extended if it happens several times. For a faster restarting, try it via App.
- Nomral household loads can be supported when the inverter is in back-up mode. Accepted loads as below:
  - Inductive loads: 1.5P non-inverter air conditioner
  - Capacitive load: total power  $\leq$  0.6 times of the inverter's nominal output power.

### Hybrid Scenarios

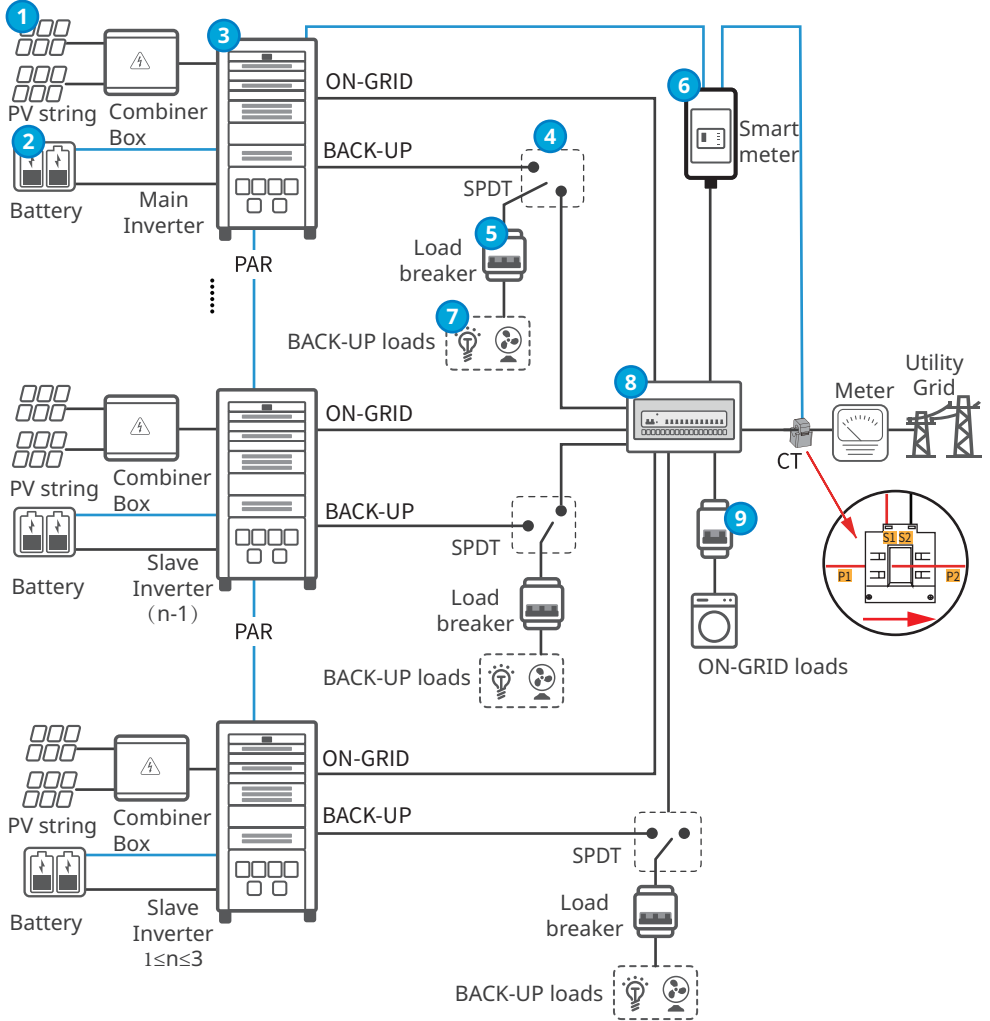

No.	Parts	Description
1	PV string	The PV string is composed of series connected PV panels. Only for hybrid inverters.
2	Battery	Select the battery model according to the inverter model and the approved battery list.
3	Inverter	Supports ETC series inverters.
4	SPDT (Single Pole, Double Throw) switch	<ul style="list-style-type: none"> <li>• An SPDT switch is recommended to ensure that the BACK-UP loads do not stop working when the inverter is off or in maintenance..</li> <li>• Recommended specifications of SPDT switch:               <ul style="list-style-type: none"> <li>• GW50K06-ETC, and GW50K07-ETC: the nominal current is <math>\geq 125A</math> and the nominal voltage is <math>\geq 415V</math>.</li> <li>• FGW100K06-ETC, and GW100K07-ETC: the nominal current is <math>\geq 250A</math> and the nominal voltage is <math>\geq 415V</math>.</li> </ul> </li> </ul>
5	Load breaker	Depends on the actual using load.
6	Smart meter	The smart meter can be purchased from the inverter manufacturer. Recommended model: GM3000C, GM330.
7	BACK-UP loads	<ul style="list-style-type: none"> <li>• Connecting BACK-UP loads, such as loads requiring 24-hour power supply or other important loads.</li> <li>• Connecting unbalanced loads. L1, L2, L3 of the inverter respectively connected to loads with different power.</li> </ul>
8	Power distribution panel	<ul style="list-style-type: none"> <li>• A distribution board should be prepared by the customer.</li> <li>• Nominal current of the distribution panel <math>\geq 2 \times N \times I_{max}</math> (N refers the quantity of the inverters in the system; <math>I_{max}</math> refers to the maximum output current of the inverter.</li> </ul>
9	Load breaker	Depends on the actual using load.

AC-Coupled Scenario

NOTICE

- Before enabling the power limit function, ensure that the AC-Coupled inverter or grid-tied PV inverter supports power limit.
- Enable the power limit function if GoodWe AC-Coupled inverter or grid-tied PV inverter is applied in the PV system. Complete the power limit settings as required if a grid-tied PV inverter from other manufacturers is applied.
- When power limit function is enabled, the PV system will purchase 2.5kW power from the utility grid.

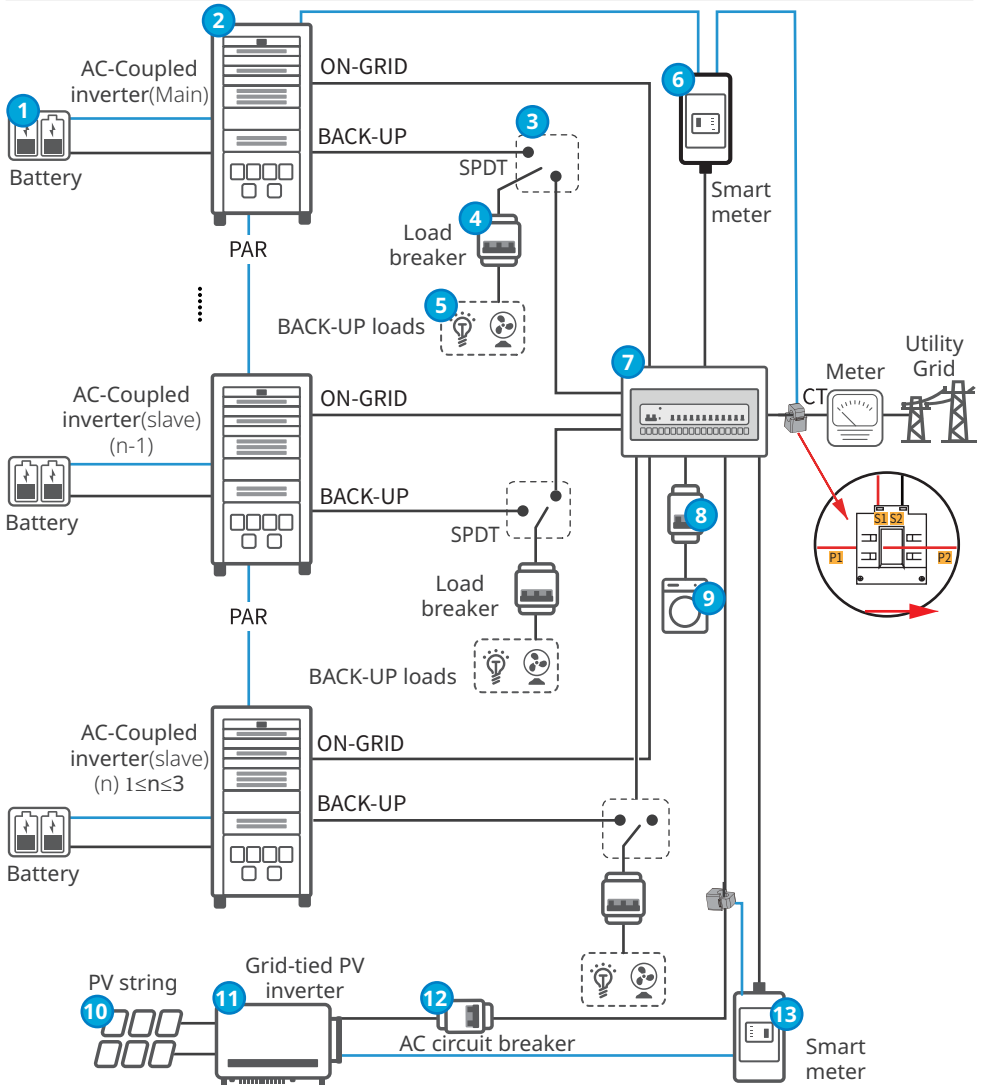

No.	Parts	Description
1	Battery	Select the battery model according to the inverter model and the approved battery list.
2	AC-Coupled inverter	Supports BTC series inverters.
3	SPDT (Single Pole, Double Throw) switch	<ul style="list-style-type: none"> <li>An SPDT switch is recommended to ensure that the BACK-UP loads do not stop working when the inverter is off or in maintenance..</li> <li>Recommended specifications of SPDT switch: <ul style="list-style-type: none"> <li>GW50K06-BTC, and GW50K07-BTC: the nominal current is <math>\geq 125A</math> and the nominal voltage is <math>\geq 415V</math>.</li> <li>FGW100K06-BTC, and GW100K07-BTC: the nominal current is <math>\geq 250A</math> and the nominal voltage is <math>\geq 415V</math>.</li> </ul> </li> </ul>
4	Load breaker	Depends on the actual using load.
5	BACK-UP loads	<ul style="list-style-type: none"> <li>Connecting BACK-UP loads, such as loads requiring 24-hour power supply or other important loads.</li> <li>Connecting unbalanced loads. L1, L2, L3 of the inverter respectively connected to loads with different power.</li> </ul>
6	Smart meter	The smart meter can be purchased from the inverter manufacturer. Recommended model: GM3000C, GM330.
7	Power distribution panel	<ul style="list-style-type: none"> <li>A distribution board should be prepared by the customer.</li> <li>Nominal current of the distribution panel <math>\geq 2 \times N \times I_{max}</math> (N refers the quantity of the inverters in the system; <math>I_{max}</math> refers to the maximum output current of the inverter.</li> </ul>
8	Load breaker	Depends on the actual using load.
9	On-grid loads	-
10	PV string	The PV string is composed of series connected PV panels.
11	Grid-tied PV inverter	Support third-part brand inverters.
12	AC breaker	The specification shall be selected according to the AC rated current of the inverter.
13	Smart meter- Only for BTC series	Please select the meter compatible with the corresponding inverter.

## 3.3 Working Mode

### 3.3.1 System Working Mode

#### Economic mode

#### NOTICE

- Select Economic mode only when it meets the local laws and regulations, e.g., whether the grid is allowed to charge the battery. If not, do not use this mode.
  - It is recommended to use economic mode in scenarios when the difference between peak and valley electricity prices is big.
- Day: when the electricity price is in the peak, use the battery to power the load first, and the remaining power can be sold to the grid.
  - Night: when the electricity price is in the valley, set the time for the grid to charge the battery.

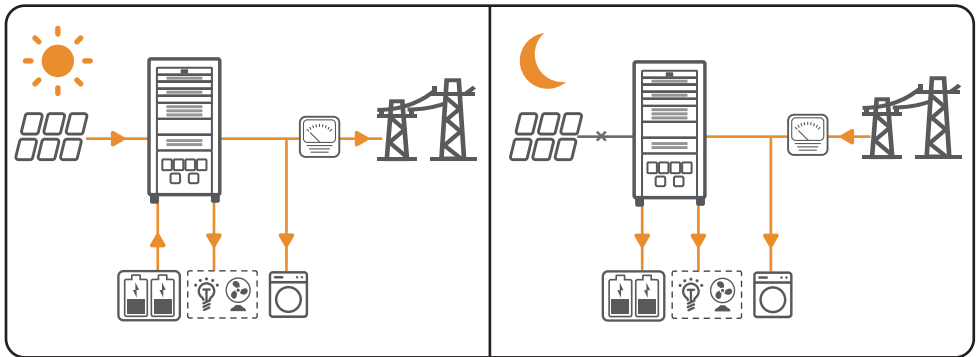



## Self consumption mode

### NOTICE

- For solar power, consider self consumption mode as priority: the excess power charges the battery in day time; the battery supplies power to the load when there is no solar power generated at night. It improves the self consumption rate and saves electricity costs.
- It is suitable for areas with high electricity prices and little or no solar power generation subsidies.

- Day:
  - When the power generated in the PV system is sufficient, it supplies the household load as priority. And the excess power charges the batteries first. The remaining power will be sold to the grid.
  - When the power generated in the PV system is insufficient, use the battery supplies the load first. If the battery power is insufficient, then the load will be powered by the grid.
- Night:
 

If the battery power is sufficient, the load will be powered by the battery. If the battery power is not enough, the load will be powered by the grid.

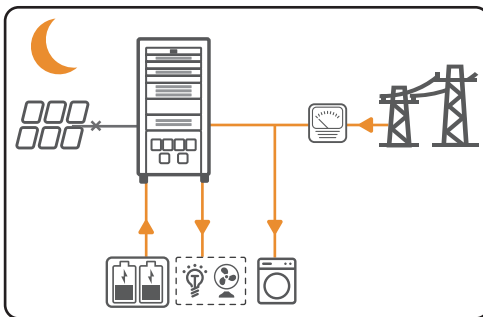
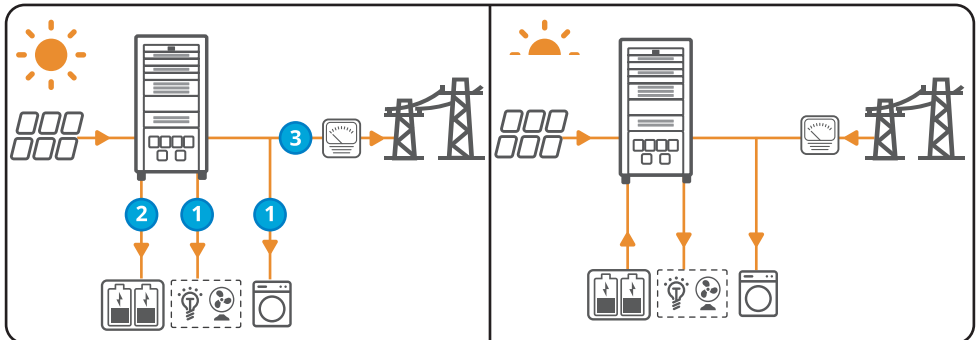

## Back-up mode

### NOTICE

- The back-up mode is mainly applied to the scenario where the grid is unstable and there is an important load. When the grid is disconnected, the inverter turns to off-grid mode to supply power to the load; when the grid is restored, the inverter switches to on-grid mode.
  - The battery stops discharging when it reaches SOC. When there is sunlight the next day, the battery starts to supply power to the load after it is charged to a certain power level.
- When the power generated in the PV system is sufficient, it charges the battery as priority. And the excess power charges the load. The remaining power will be sold to the grid.
  - When there is no power generated in the PV system:
    - The grid supplies the load when the power grid is normal.
    - The inverter enters off-grid mode and the battery supplies power to the load when the grid is abnormal.

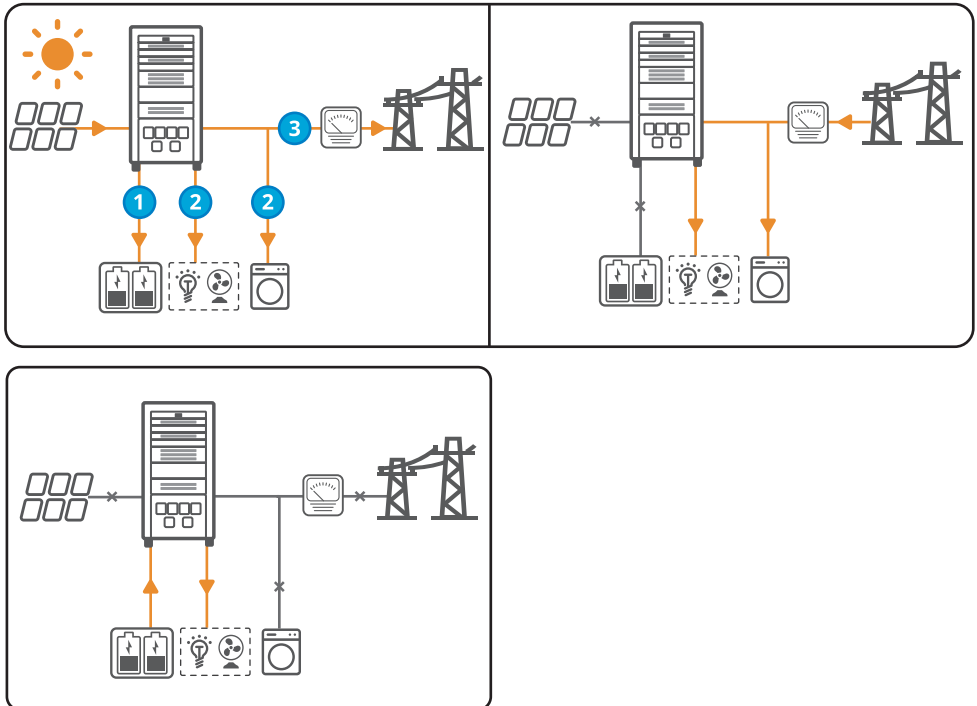

### Peak Shaving Mode

#### NOTICE

Peak shaving mode is mainly applicable to industrial and commercial scenarios. When the total power consumption of the loads exceeds the peak shaving limit, the battery discharges to reduce the power consumption exceeds the peak shaving limit.

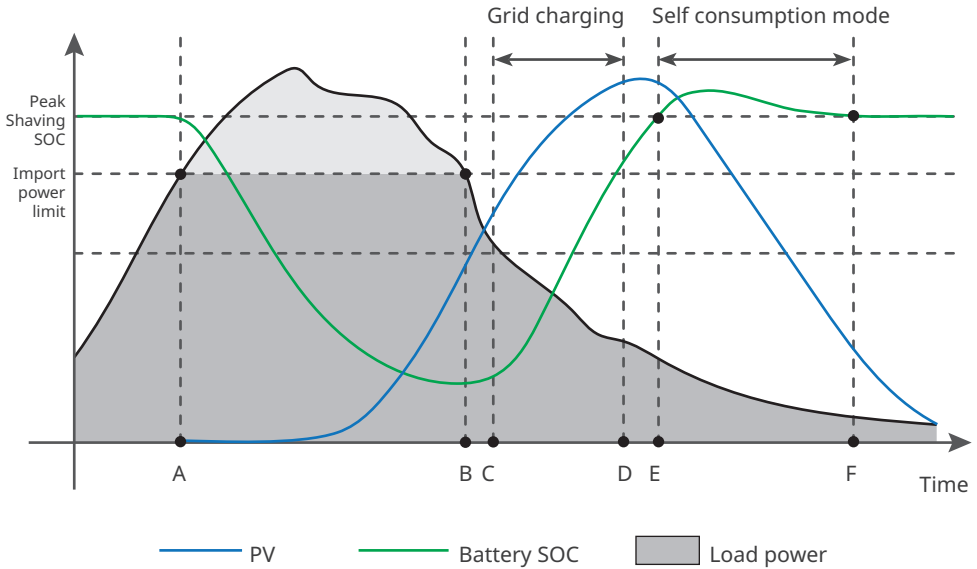

Time	Description
A	To make sure that the electricity buying from the grid is under the Import power limit, the PV system, battery, and grid power the loads together once the Load power exceeds the Import power limit.
B	To make sure that the electricity buying from the grid is under the Import power limit, the PV system, battery, and grid power the loads together once the Load power exceeds the Import power limit. The grid continues to power the loads while the PV system charges the battery in priority.
C	The grid charges the battery between the start time (C) and end time (D). The time is set in SolarGo app. Refer to the SolarGo app user manual at <a href="https://en.goodwe.com">https://en.goodwe.com</a> .
D	After D, the PV system keeps charging the battery, but the grid stops charging until the Battery SOC reaches Peak Shaving SOC.
E	The battery enters self consumption mode as the Battery SOC is at or higher than Peak Shaving SOC. The PV system takes priority to power the loads, and the excess power charges the battery.
F	Under self consumption mode, the battery stops discharging for loads as Peak Shaving SOC is reached.

### 3.3.2 Inverter operation mode

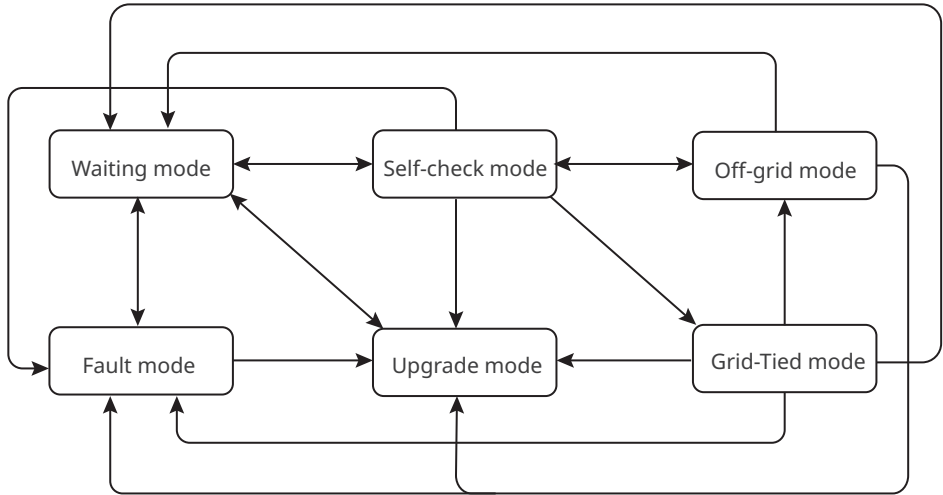

No.	Parts	Description
1	Waiting mode	Waiting stage after the inverter is powered on. <ul style="list-style-type: none"> <li>When the conditions are met, it enters the self-check mode.</li> <li>If there is a fault, the inverter enters the Fault mode.</li> <li>If there is an update request, the inverter enters the Updating mode.</li> </ul>
2	Self-check mode	Before the inverter starts up, it continuously performs self-check, initialization, etc. <ul style="list-style-type: none"> <li>When the conditions are met, it enters the Grid-tied mode, and the inverter starts the on grid connection.</li> <li>If the grid is not detected, it enters the Off-grid mode and the inverter runs off-grid; if the inverter has no off-grid function, it enters the Wait mode.</li> <li>If the self-check is not passed, it enters the Fault mode.</li> <li>If there is an update request, the inverter enters the Updating mode.</li> </ul>
3	Grid-Tied mode	The inverter is successfully connected to the grid. <ul style="list-style-type: none"> <li>If the grid is not detected, it enters the Off-grid mode.</li> <li>If a fault is detected, it enters the Fault mode.</li> <li>If the conditions do not meet the requirements for grid connection, and the off-grid output function is not turned on, it enters the Wait mode.</li> <li>If there is an update request, the inverter enters the Updating mode.</li> </ul>

No.	Parts	Description
4	Off-grid mode	<p>When the grid is powered off, the inverter switches to the Off-grid mode and continues to supply power to the load via BACK-UP port.</p> <ul style="list-style-type: none"> <li>• If a fault is detected, it enters the Fault mode.</li> <li>• If the conditions do not meet the requirements for grid connection and the off-grid output function is not turned on, it enters the Wait mode.</li> <li>• If the conditions meet the requirements for grid connection and the off-grid output function is turned on, it enters the Self-check mode.</li> <li>• If there is an update request, the inverter enters the Updating mode.</li> </ul>
5	Fault mode	<ul style="list-style-type: none"> <li>• If a fault is detected, the inverter enters the Fault mode. When the fault is cleared, it enters the Wait mode.</li> <li>• If there is an upgrade request, the inverter enters the Updating mode.</li> </ul>
6	Updating mode	<p>Enters the Upgrade mode when the inverter is upgrading the software. When the upgrading is finished, it enters the Waiting mode.</p>

## 3.4 Features

### Power derating

For a safe operation, the inverter will automatically reduce the output power when the operating environment is not ideal.

The following are the factors that may cause power derating. Please try to avoid them when the inverter is working.

- Unfavorable environmental conditions, e.g., direct sunlight, high temperature, etc.
- Inverter's output power percentage has been set.
- The voltage of the grid varies with the frequency.
- Higher input voltage value.
- Higher input current value.

### 3.5 Appearance

#### 3.5.1 Parts

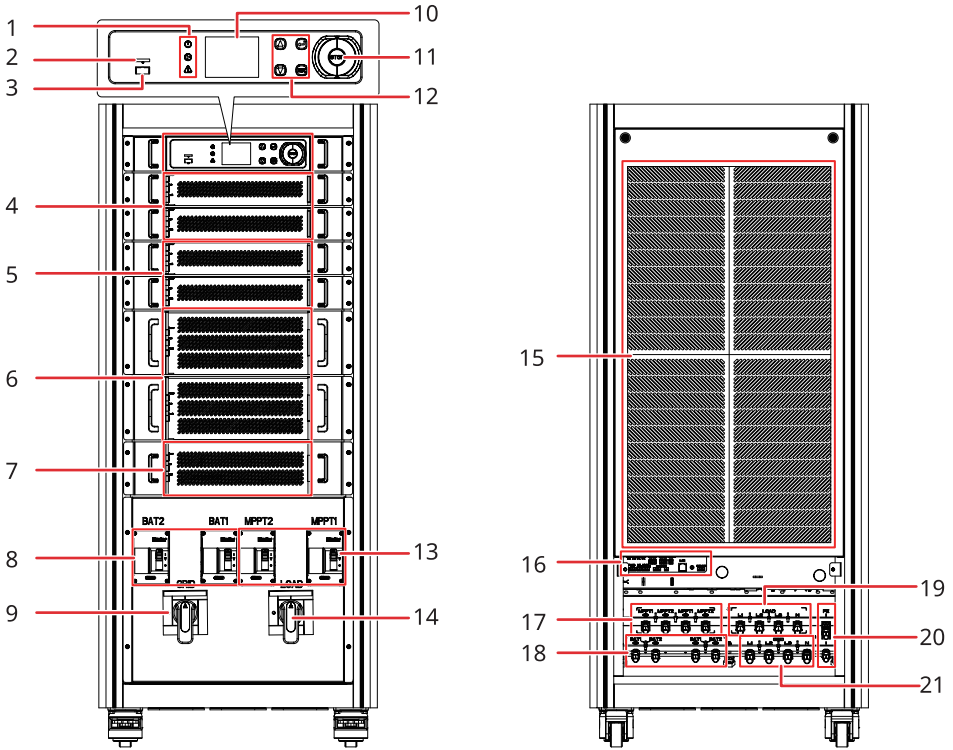







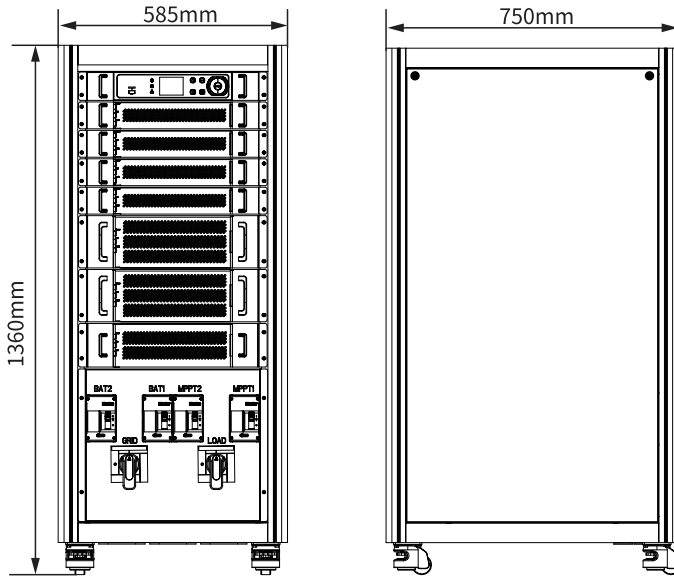



No.	Parts	Description
1	Indicator	Indicates the working status of the inverter.
2	TF card socket	TF card can be inserted.
3	USB communication port	The inverter software version can be upgraded locally by USB flash drive.
4	MPPT module	The inverter collects PV input voltage and current through the module. <ul style="list-style-type: none"> <li>• Only for ETC series.</li> </ul>
5	DC-DC conversion module	<ul style="list-style-type: none"> <li>• Supports single battery input and dual battery input. For dual battery input, the two batteries can be different brands.</li> <li>• Realize communication between the inverter and the battery.</li> </ul>
6	DC-AC conversion module	Converts DC input voltage to AC voltage.

No.	Parts	Description
7	On-grid/off-grid switching module	<ul style="list-style-type: none"> <li>Switches the working mode of the inverter between on-grid mode and off-grid mode.</li> <li>Only for GW50K05-ETC, GW50K07-ETC, GW100K05-ETC, GW100K07-ETC, GW50K05-BTC, GW50K07-BTC, GW100K05-BTC, and GW100K07-BTC.</li> </ul>
8	Battery circuit breaker (BAT1, BAT2)	Starts or stops battery input and output.
9	AC circuit breaker (GRID)	Starts or stops on-grid AC output.
10	LCD	Used to check the parameters of the inverter.
11	Emergency stop button	Press the button for emergency protection.
12	Button	Used to select menus displayed on the screen.
13	MPPT input circuit breaker (MPPT1, MPPT2)	<ul style="list-style-type: none"> <li>Starts or stops PV input.</li> <li>Only for ETC series.</li> </ul>
14	Load breaker (LOAD)	Starts or stops back-up AC output.
15	Heat sink	For heat dissipation.
16	Communication ports	Connects communication cables, including RS485 cable, BMS cable, CAN cable, DRED cable, RCR cable, smart meter cable, remote shutdown cable, LAN cable.
17	DC input terminal (MPPT1, MPPT2)	<ul style="list-style-type: none"> <li>Connects PV input cables.</li> <li>Only for ETC series.</li> </ul>
18	Battery input terminal (BAT1, BAT2)	Connects battery cables.
19	Load cable terminal (LOAD)	Connects load cables.
20	Grounding Point (PE)	Connects the grounding cable.
21	AC output terminal	Connects the AC output cable.

### 3.5.2 Dimension



### 3.5.3 Indicator Description

Indicator Status		Description
 Power		ON=INVERTER POWER-ON
		OFF=INVERTER POWER-OFF
 Operating		ON=SYSTEM IS READY
		BLINK=SYSTEM IS STARTING UP
		OFF=SYSTEM IS NOT OPERATING
 Fault		ON=FAULT HAS OCCURED
		BLINK=BURN-IN MODE
		OFF=NO FAULT



### 3.5.4 Nameplate

The nameplate is for reference only.

<b>GOODWE</b>	
<b>Product:</b> ***** Inverter	
<b>Model :</b> ***** **	
PV Input	UDCmax: ****Vd.c.
	UMPP: ** .. **Vd.c.
	IDC,max: ***Ad.c.
Battery	ISC PV: ***Ad.c.
	Ubatt: *** .. **Vd.c., L-Hbn Ibatt,max (C/D): ***/**Ad.c.
On-grid	UAC,r: ***Va.c.
	fAC, r: **Hz
	PAC,r:***kW
	IAC,max (to grid): ***Aa.c.
	Sr (to grid): ***kVA
	Smax (to grid): ***kVA
	IAC,max (from grid): ***Aa.c.
Back-up	Sr (from grid): ***kVA
	Smax (from grid): ***kVA
	UAC,r: ***Va.c.
	fAC, r: **Hz
	IAC,max: ***Aa.c.
Sr: ***kVA	
Smax: **kVA	
P.F.: *,*cap...nd, T operating: -*+** °C (>** °C derating)	
Non-isolated, IP**, Protective Class I, OVC DCII/ACIII	
	
S/N:	
***** Co., Ltd. E-mail: *****@****.com *****@****.com	
S/N	

GW trademark, product type, and product model

Technical parameters

Safety symbols and certification marks

Contact information and serial number

## 4 Check and Storage

### 4.1 Check Before Receiving

Check the following items before receiving the product.

1. Check the outer packing box for damage, such as holes, cracks, deformation, and other signs of equipment damage. Do not unpack the package and contact the supplier as soon as possible if any damage is found.
2. Check the inverter model. If the inverter model is not what you requested, do not unpack the product and contact the supplier.
3. Check the deliverables for correct model, complete contents, and intact appearance. Contact the supplier as soon as possible if any damage is found.

### 4.2 Deliverables



#### WARNING

Prepare the PV connectors for connecting the DC input cables according to the recommended specifications. Severe damage might happen if other types of connectors or terminals are used, which are beyond the manufacturer's liability.

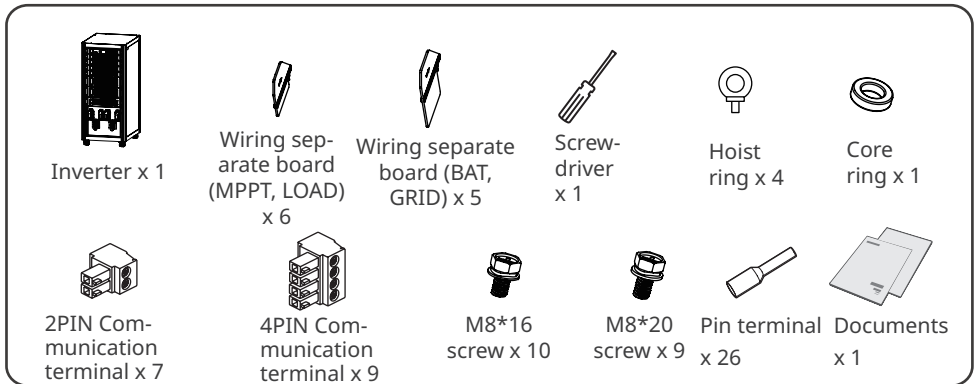

## 2 Batteries are Connected to Single BAT Port of an Inverter

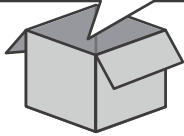
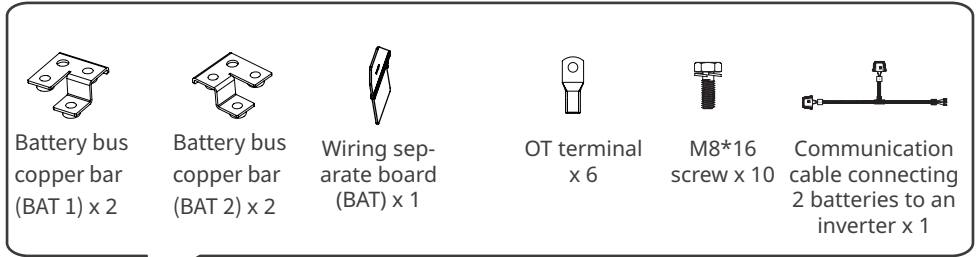

## 3 Batteries are Connected to Single BAT Port of an Inverter

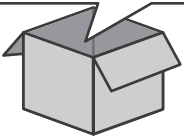
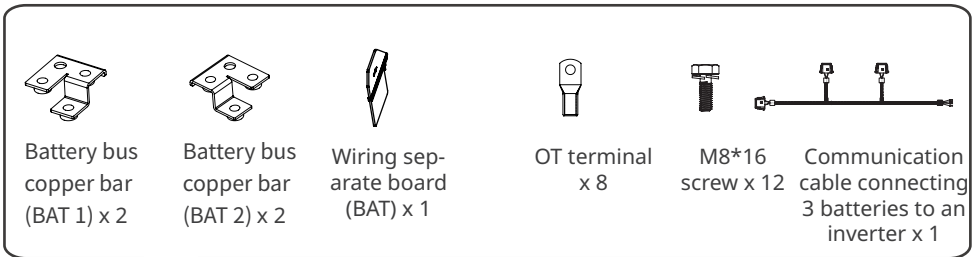

## 4.3 Storage

If the equipment is not to be installed or used immediately, please ensure that the storage environment meets the following requirements:

1. Do not unpack the outer package or throw the desiccant away.
2. Store the equipment in a clean place. Make sure the temperature and humidity are appropriate and no condensation.
3. The height and direction of the stacking inverters should follow the instructions on the packing box.
4. The inverters must be stacked with caution to prevent them from falling.
5. If the inverter has been long term stored, it should be checked by professionals before being put into use.

## 5 Installation

### 5.1 Installation Requirements

#### Installation Environment Requirements

1. Do not install the equipment in a place near flammable, explosive, or corrosive materials.
2. Do not install the equipment in a place that is easy to touch, especially within children's reach. High temperature exists when the equipment is working. Do not touch the surface to avoid burning.
3. Install the equipment in a sheltered place to avoid direct sunlight, rain, and snow.
4. The Ingress Protection Rating is IP20, please install the inverters indoors.
5. The place to install the equipment shall be well-ventilated for heat dissipation and large enough for operations.
6. The equipment can be installed indoors. The temperature and humidity at the installation site should be within the appropriate range.
7. Install the equipment at a height that is convenient for operation and maintenance, electrical connections, and checking indicators and labels.
8. The altitude to install the inverter shall be lower than the maximum working altitude 4000m.
9. Install the equipment away from electromagnetic interference. If there is any radio or wireless communication equipment below 30MHz near the equipment, you have to:
  - Add a multi-turn winding ferrite core at the DC input line or AC output line of the inverter, or add a low-pass EMI filter.
  - Install the inverter at least 30m far away from the wireless equipment.
10. The length of the DC and communication cables between the battery and inverter should be less than 3m. Please ensure that the distance between the inverter and the battery meets the cable length requirements. If the distance between the inverter and the battery is greater than 3m, ensure that there are no electromagnetic compatibility sensitive devices around.

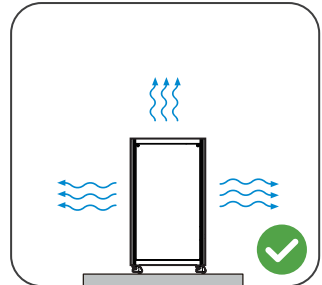
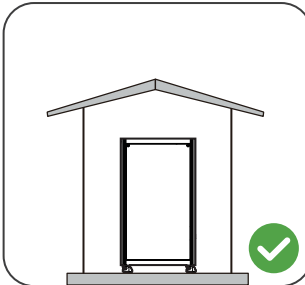
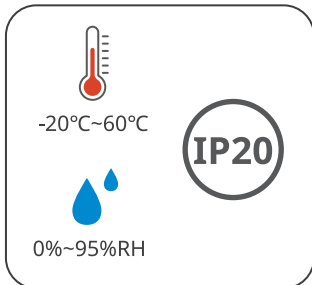
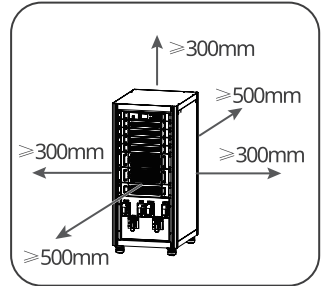
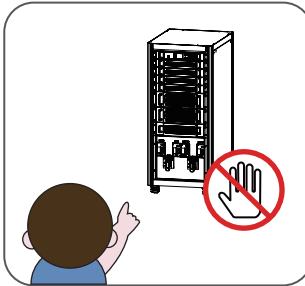
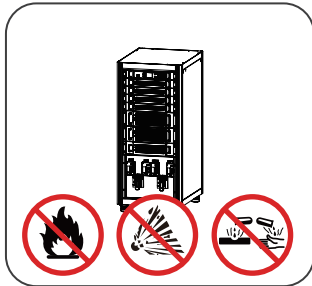

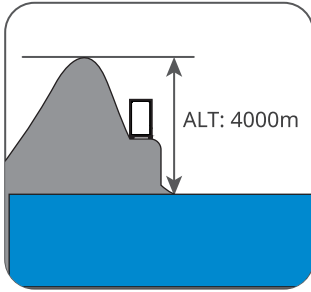

### Mounting Support Requirements

- The mounting support shall be nonflammable and fireproof.
- Install the equipment on a surface that is solid enough to bear the inverter weight.
- Do not install the product on the support with poor sound insulation to avoid the noise bothering people nearby.

### Installation Angle Requirements

Make sure the equipment is installed vertically and not tilted or upside down.

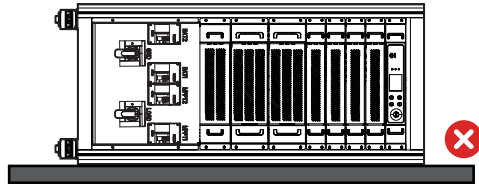
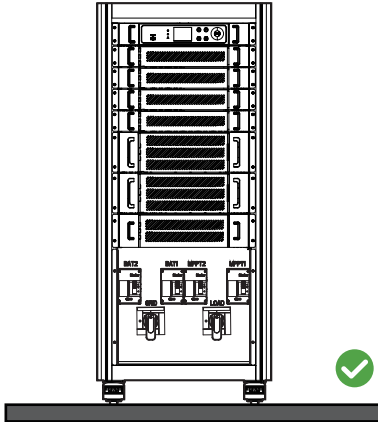

### Installation Tool Requirements

The following tools are recommended when installing the equipment. Use other auxiliary tools on site if necessary.

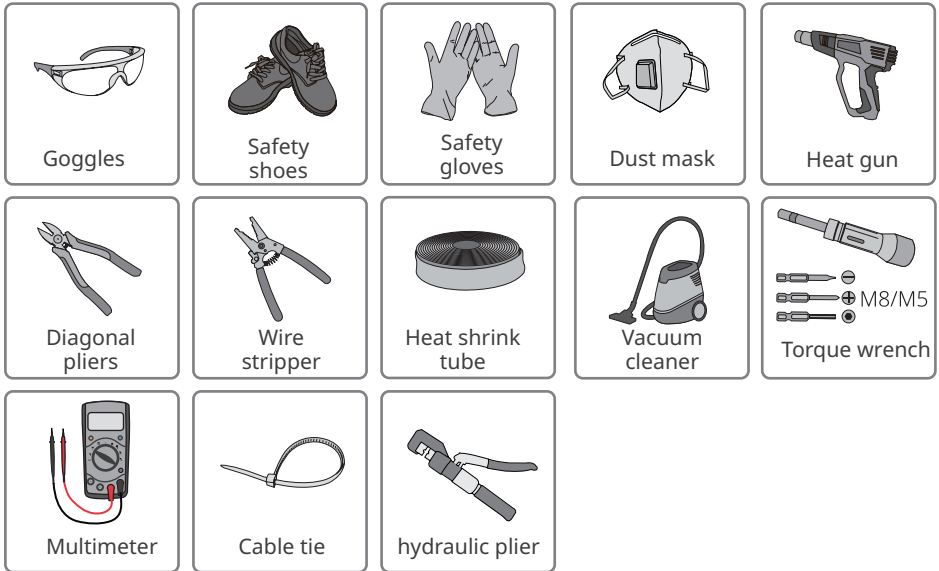

## 5.2 Inverter Installation

### 5.2.1 Moving the Inverter



- Operations such as transportation, shipment, installation and so on shall in compliance with the laws and regulations of the country or region where the inverter is located.
- Move the inverter to the site before installation. Follow the instructions below to avoid personal injury or equipment damage.
  1. Consider the weight of the equipment before moving it. Assign enough personnel to move the equipment to avoid personal injury.
  2. Wear safety gloves to avoid personal injury.
  3. Keep balance to avoid falling down when moving the equipment.

### 5.2.2 Installing the Inverter

#### NOTICE

- Make sure the inverter is firmly installed in case of falling down.

### Hoisting the inverter (optional)

**step 1** Install the hoisting ring to the inverter and tighten it.

**Step 2** Hoist the inverter.

### Fix the inverter

**Step** screw the four pulleys of the inverters.

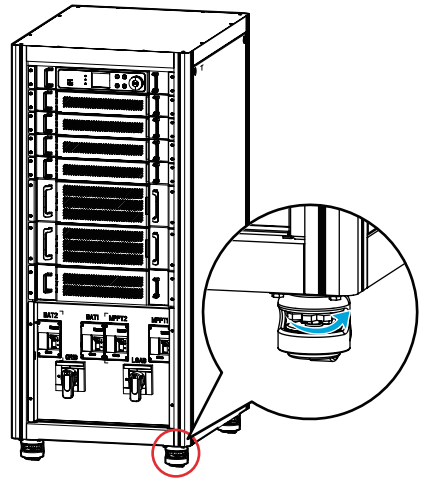
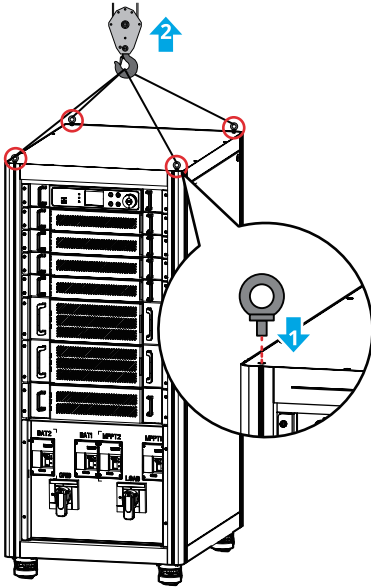

## 6 Electrical Connection

### 6.1 Safety Precaution



- Perform electrical connections in compliance with local laws and regulations. Including operations, cables, and component specifications.
- Disconnect the DC switch, AC output switch, and battery switch of the inverter to power off the inverter before any electrical connections. Do not work with power on. Otherwise, an electric shock may occur.
- Tie the cables of the same type together, and place cables of different types apart. Do not place the cables entangled or crossed.
- If the tension is too large, the cable may be poorly connected. Reserve a certain length of the cable before connecting it to the inverter cable port.
- Make sure that the cable conductor is in full contact with the terminal and the cable insulation part is not crimped with the terminal when crimping the terminal. Otherwise, the inverter may not be able to work properly, or the connection may be unreliable during working, which may cause terminal block damage, etc.

#### NOTICE

- Wear personal protective equipment like safety shoes, safety gloves, and insulating gloves during electrical connections.
- All electrical connections should be performed by qualified professionals.
- Cable colors in this document are for reference only. The cable specifications shall meet local laws and regulations.

#### Cable requirements:

No.		Type	Specification
1	DC Input Cable (MPPT) DC Power Cable (BATTERY)	Single-core Outdoor Copper-core Cable or Aluminum Cable	Copper Cable Conductor Cross Sectional Area: $35\text{mm}^2 \leq S \leq 70\text{mm}^2$ Aluminum Cable Conductor Cross Sectional Area: $50\text{mm}^2 \leq S \leq 95\text{mm}^2$
2	PE Cable	Single-core Outdoor Copper-core Cable	Conductor cross sectional area $S_{PE} \geq S/2$



User	Manual V1.2-2024	10-30	ETC/BTC 50K series: • Single core cable outer diameter: 8-11mm • Multi-core cable outer diameter: 30-39mm • Copper Cable Conductor Cross Sectional Area(S): 35mm <sup>2</sup> ≤S≤70 mm <sup>2</sup> ; • Aluminum Cable Conductor Cross Sectional Area: 50mm <sup>2</sup> ≤S≤95 mm <sup>2</sup> ETC/BTC 100K series: • Single core cable outer diameter: 9-11mm • Multi-core cable outer diameter: 33-39mm • Copper Cable Conductor Cross Sectional Area(S): 50mm <sup>2</sup> ≤S≤70 mm <sup>2</sup> ; • Aluminum Cable Conductor Cross Sectional Area: 70mm <sup>2</sup> ≤S≤95 mm <sup>2</sup>
3	AC Output Cable (GRID)	Single-core or Multi-core Outdoor Copper-core Cable or Aluminum Cable	ETC/BTC 50K series: • Single core cable outer diameter: 8-11mm • Multi-core cable outer diameter: 30-39mm • Copper Cable Conductor Cross Sectional Area(S): 35mm <sup>2</sup> ≤S≤70 mm <sup>2</sup> ; • Aluminum Cable Conductor Cross Sectional Area: 50mm <sup>2</sup> ≤S≤95 mm <sup>2</sup> ETC/BTC 100K series: • Single core cable outer diameter: 9-11mm • Multi-core cable outer diameter: 33-39mm • Copper Cable Conductor Cross Sectional Area(S): 50mm <sup>2</sup> ≤S≤70 mm <sup>2</sup> ; • Aluminum Cable Conductor Cross Sectional Area: 70mm <sup>2</sup> ≤S≤95 mm <sup>2</sup>
4	AC Output Cable (LOAD)	Single-core or Multi-core Outdoor Copper-core Cable or Aluminum Cable	ETC/BTC 50K series: • Single core cable outer diameter: 8-11mm • Multi-core cable outer diameter: 30-39mm • Copper Cable Conductor Cross Sectional Area(S): 35mm <sup>2</sup> ≤S≤70 mm <sup>2</sup> ; • Aluminum Cable Conductor Cross Sectional Area: 50mm <sup>2</sup> ≤S≤95 mm <sup>2</sup> ETC/BTC 100K series: • Single core cable outer diameter: 9-11mm • Multi-core cable outer diameter: 33-39mm • Copper Cable Conductor Cross Sectional Area(S): 50mm <sup>2</sup> ≤S≤70 mm <sup>2</sup> ; • Aluminum Cable Conductor Cross Sectional Area: 70mm <sup>2</sup> ≤S≤95 mm <sup>2</sup>
5	RS485, remote shutdown, DRED, RCR communication Cable	Outdoor Shielded Twisted Pair	Conductor Cross Sectional Area: 0.25 mm <sup>2</sup> - 1 mm <sup>2</sup>
	CAN communication Cable for inverter Paralleling	Straight-through Ethernet cable*1	.

Note:

\*1: please use one set of the twisted pairs.

[1] A copper to aluminum wiring terminal is required when using an aluminum cable.

[2] Cable length of the RS485 communication cable: ≤1000m.

The values in this table are valid only if the external protective earthing conductor and the phase conductors are the same material. Otherwise, the cross-sectional area of the external protective earthing conductor is to be determined in a manner which produces a conductance equivalent to that which results from the application of this table.

## 6.2 System Wiring Diagram

### NOTICE

- N and PE wiring via ON-GRID and BACK-UP ports of the inverter are different based on the regulation requirements of different regions. Refer to the specific requirements of local regulations.
- There are built-in relays inside of the inverter's ON-GRID and BACK-UP AC ports. When the inverter is in the off-grid mode, the built-in ON-GRID relay is open; while when the inverter is in grid-tied mode, it is closed.
- When the inverter is powered on, the BACK-UP AC port is charged. Power off the inverter first if maintenance is required for the loads connected with BACK-UP ports. Otherwise, it may cause electric shock.
- Only ETC series inverters support PV string connection.

### N and PE cables are connected together in the Main Panel for wiring.

### NOTICE

Below wirings are applicable to areas in Australia, New Zealand and etc.

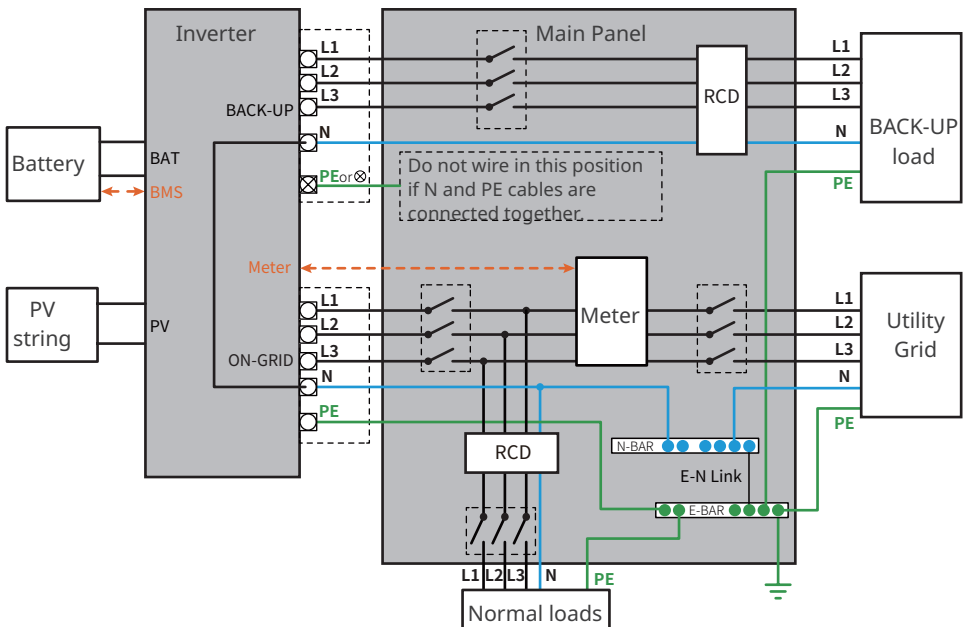

## N and PE cables in the Main Panel shall be wired separately.

### NOTICE

Ensure that the grounding of BACK-UP is correctly and tightened. Otherwise, the BACK-UP function may be abnormal in case of grid failure.  
Other areas except Australia, New Zealand etc., are applicable to the following wirings:

- In Germany, the internal relay will connect the N wire and PE cable in back-up mode in 100ms. The internal relay will be disconnected in ON-GRID mode. In areas other than Germany, the internal relay is disconnected by default in either mode.

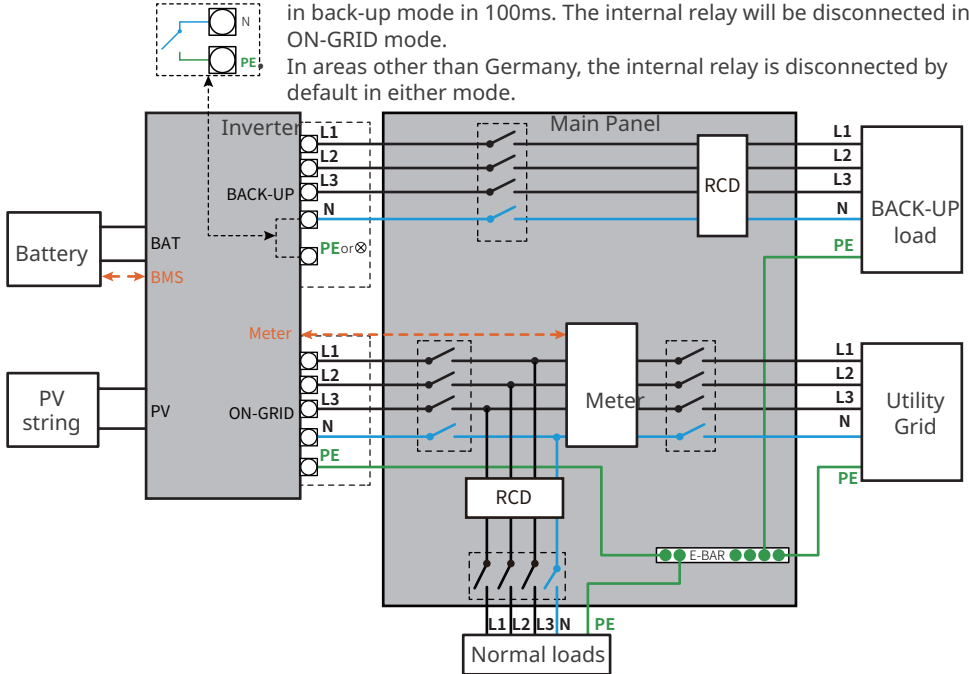

## Detailed Wiring Diagram

For detailed wiring, please scan the QR code below or visit: [https://en.goodwe.com/Ftp/EN/Downloads/User%20Manual/GW\\_Commercial-Smart-Inverter-Solutions\\_Quick-Guide-ETC-BTC50-100K-EN.pdf](https://en.goodwe.com/Ftp/EN/Downloads/User%20Manual/GW_Commercial-Smart-Inverter-Solutions_Quick-Guide-ETC-BTC50-100K-EN.pdf) to view "ETC & BTC Series 50 kW - 100kW Hybrid & AC-coupled Inverter Solutions Guide"



### 6.3 Opening the Door of the Wiring Compartment

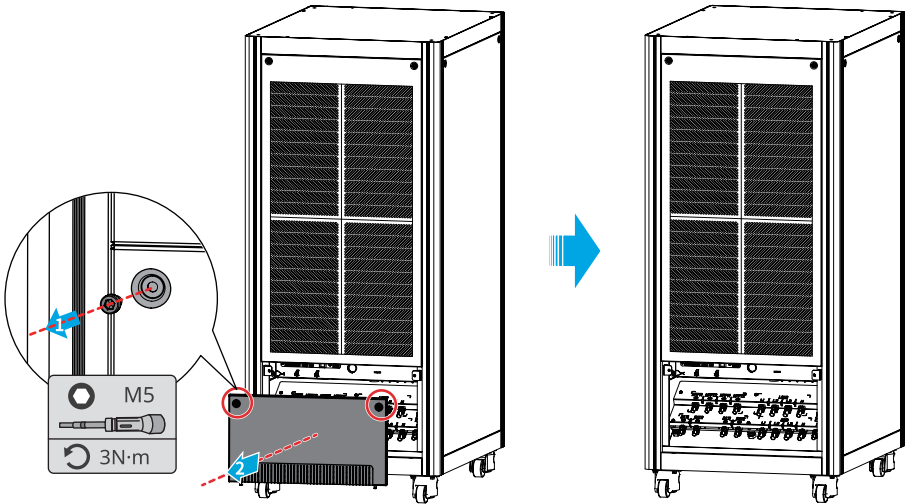

#### NOTICE

The door of the wiring compartment is not pre-drilled for the wire inlet hole. A hobby knife is required to cut a hole according to the outer diameter of the cable. Make sure that the size of the inlet hole is appropriate so that the gap is not too large, which could lead to insects, rodents or other animals entering the equipment and causing damage to the equipment.

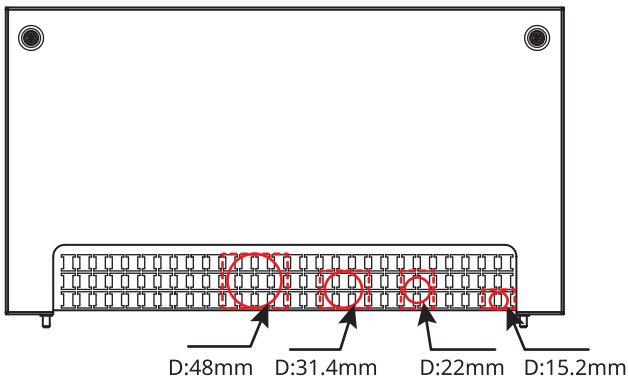

## 6.4 Connecting the PE cable

### WARNING

- The PE cable on the top wiring board cannot replace the PE cable connected to the AC output port. Make sure that both of the two PE cables are securely connected.
- Make sure that all the grounding points on the top wiring board are equipotential connected when there are multiple inverters.
- To improve the corrosion resistance of the terminal, you are recommended to apply silica gel or paint on the ground terminal after installing the PE cable.
- The PE cable should be prepared by the customer.

PE terminals need to be provided by customer, and the reference specifications are as follows:

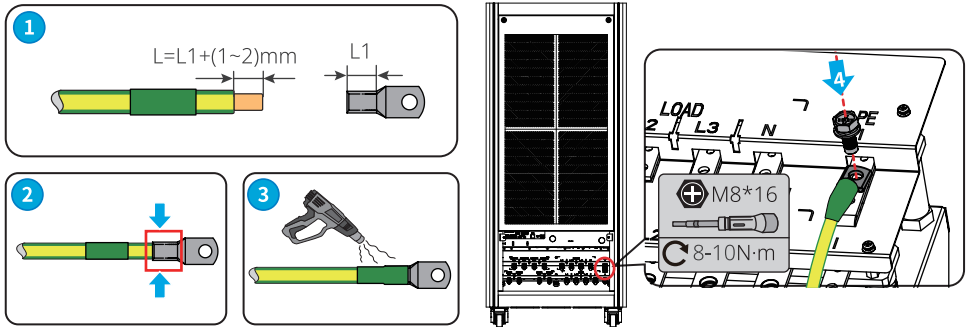

## 6.5 Connecting AC Output Cable, Load Output Cable, Battery Cable, and PV Input Cable

### Safety Precautions - AC Output Cable

### WARNING

- Do not connect loads between the inverter and the AC switch directly connected to the inverter.
- The residual current monitoring unit (RCMU) is integrated into the inverter. When the leakage current exceeds the allowable limit, the inverter will disconnect from the grid quickly.
- When the inverter is powered on, the BACK-UP AC port is live. Power off the inverter first if maintenance is required for the loads connected with BACK-UP ports. Otherwise, it may cause electric shock.

Connect a Residual Current Device (RCD for short) based on local laws and regulations. Type A RCDs can be connected to the outside of the inverter for protection when the DC component of the leakage current exceeds the limit value. The following RCDs are for reference:

Inverter Model	RCD Type (GRID)	RCD Type (BACK-UP)
GW50K05-ETC	500mA	30mA
GW50K06-ETC		
GW50K07-ETC		
GW100K05-ETC	1000mA	
GW100K06-ETC		
GW100K07-ETC		
GW50K05-BTC	500mA	
GW50K06-BTC		
GW50K07-BTC		
GW50K05-BTC	1000mA	
GW100K06-BTC		
GW100K07-BTC		

 **WARNING**

- Pay attention to the L1, L2, L3, N and PE terminals. Connect the AC cables to the corresponding terminals. The inverter may be damaged if the cables are connected to the wrong terminal.
- Ensure that the whole cable cores are inserted into the terminal holes. No part of the cable core can be exposed.
- Ensure that the cables are connected securely. Otherwise it will cause damage to the inverter due to overheat during its operation.
- Connect the ON-GRID cable before BACK-UP cable when connecting the AC cables.

**NOTICE**

Load Output Cable only for GW50K07-ETC, GW100K07-ETC, GW50K07-BTC, GW100K07-BTC.

**Safety Precautions - PV Input Cable**

 **DANGER**

- Do not connect one PV string to more than one inverter at the same time. Otherwise, it may cause damage to the inverter.
- Confirm the following information before connecting the PV string to the inverter. Otherwise, the inverter may be damaged permanently or even cause fire and cause personal and property losses.
  1. Make sure that the max short circuit current and the max input voltage per MPPT are within the permissible range.
  2. Make sure that the positive pole of the PV string connects to MPPT+ of the inverter. And the negative pole of the PV string connects to MPPT- of the inverter.

 **WARNING**

- The PV strings cannot be grounded. Ensure the minimum insulation resistance of the PV string to the ground meets the minimum insulation resistance requirements before connecting the PV string to the inverter ( $R = \text{maximum input voltage} / 30\text{mA}$ ).
- Ensure the DC cables are connected tightly and securely.
- Measure the DC cables using a multimeter to avoid reverse polarity connection. Also, the voltage should be under the permissible range.

**NOTICE**

PV Input Cable only for ETC series.

**Safety Precautions - Battery Cable** **DANGER**

- The battery used with the inverter shall be approved by the inverter manufacturer. The approved battery list can be obtained through the official website.
- A short circuit in the battery may cause personal injury. The instantaneous high current caused by a short circuit can release a large amount of energy and may cause a fire.
- Before connecting the battery cable, ensure the inverter and the battery, and downstream&upstream switches, are all disconnected.
- It is forbidden to connect and disconnect the battery cables when the inverter is running. Otherwise it may cause electric shock.
- Do not connect one battery pack to more than one inverter at the same time. Otherwise, it may cause damage to the inverter.
- It is forbidden to connect loads between the inverter and batteries.
- When connecting battery cables, use insulated tools to prevent accidental electric shock or short circuit to the batteries.
- Ensure that the open circuit voltage of the battery is within the permissible range of the inverter.
- Install a DC breaker between the inverter and the battery.

 **WARNING**

- Connect the battery cables to the corresponding terminals such BAT1, BAT2, and grounding ports correctly. Otherwise it will cause damage to the inverter.
- Ensure the DC cables are connected tightly and securely.
- Measure the DC cables using a multimeter to avoid reverse polarity connection. Also, the voltage should be under the permissible range.

**step 1** Prepare cables.

**Step 2** Crimp the wiring terminals.

**Step 3** Apply the heat shrink tube

**Step 4** Connect the cables to the wiring board.

**Step 5** Insert the separate board to the wiring board.

 **WARNING**

Please ensure that the Wiring separate board is installed correctly, no Wiring separate board may cause damage to the inverter.

DC & AC wiring terminals need to be provided by customer, and the reference specifications are as follows:

<p><b>1 (PV&amp;BAT)</b></p> <p><b>Cu</b></p>	<p><b>Al</b></p>
<p><b>(AC) ETC/BTC50K</b></p> <p><b>Cu</b></p>	<p><b>Al</b></p>
<p><b>(AC) ETC/BTC100K</b></p> <p><b>Cu</b></p>	<p><b>Al</b></p>



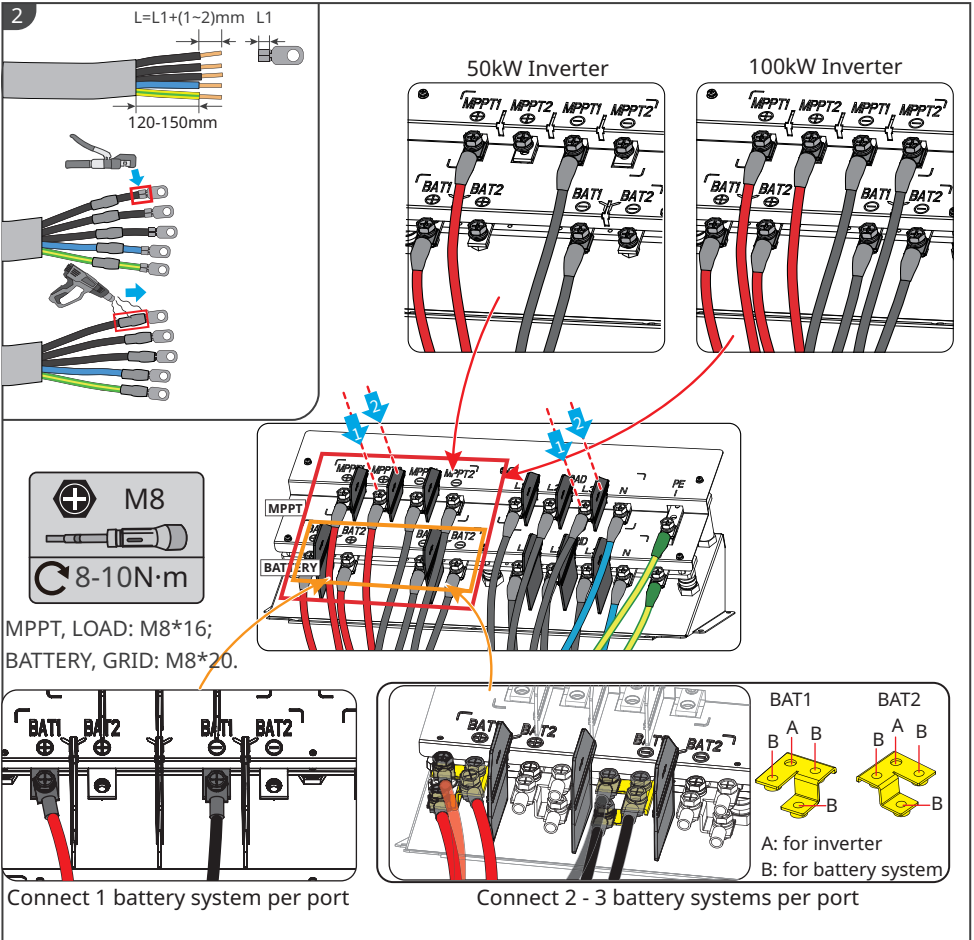

## 6.6 Communication

### NOTICE

- Make sure that the communication device is connected to the right COM port. Route the communication cable far away from any interference source or power cable to prevent the signal from being influenced.
- When connecting the communication cable, please ensure that the shielding layer is connected to the grounding point.
- If the communication signal is interfered, a magnetic ring can be added on the communication cable.
- Enable the DRED function or remote shutdown function via SolarGo app after cable connections.

### 6.6.1 Communication Port Introduction

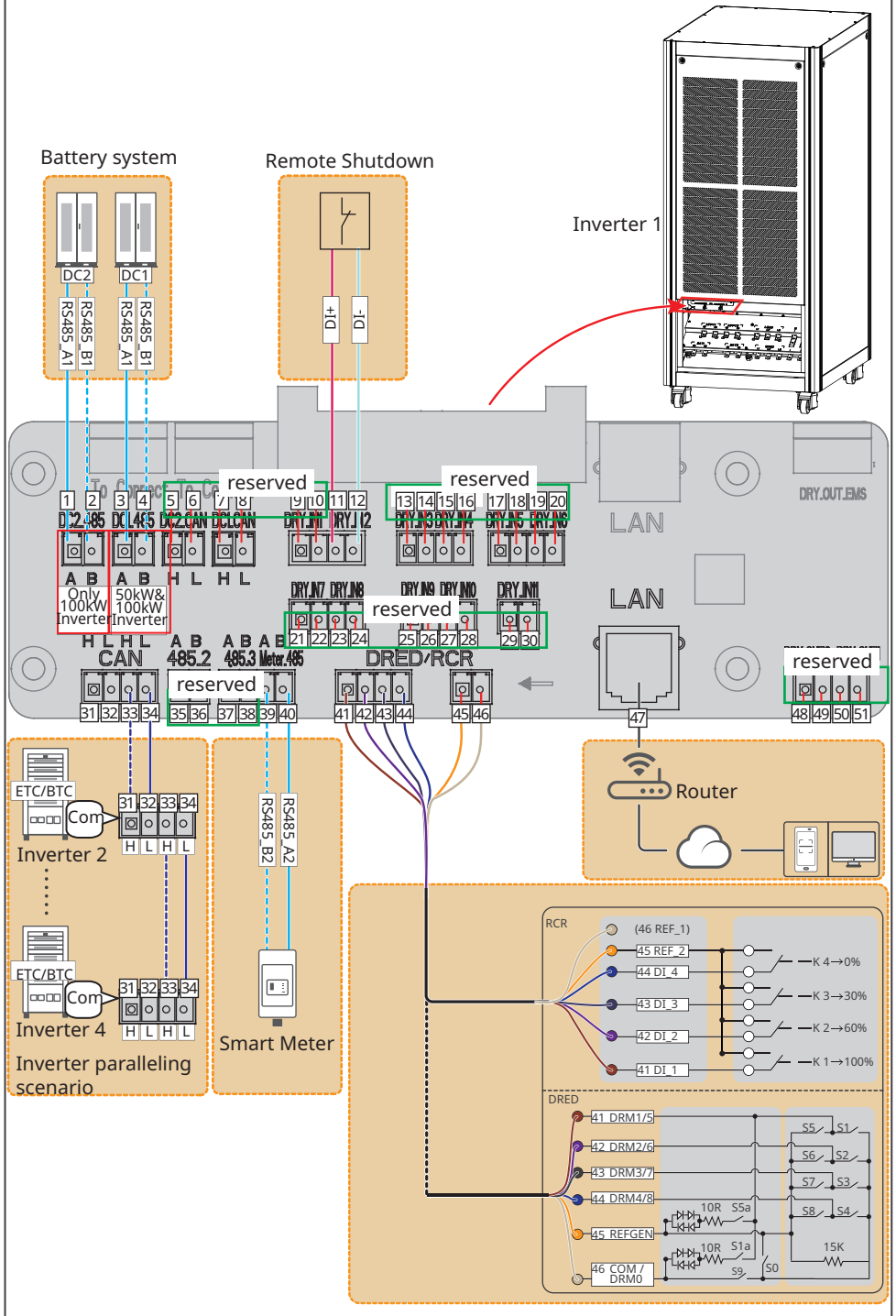

## 6.6.2 Connecting the Communication Cable

RS485, CAN, Remote Shutdown, DRED and RCR

### NOTICE

The communication cables are connected in the same way. The following illustration shows an example of connecting to 2 Pin terminal.

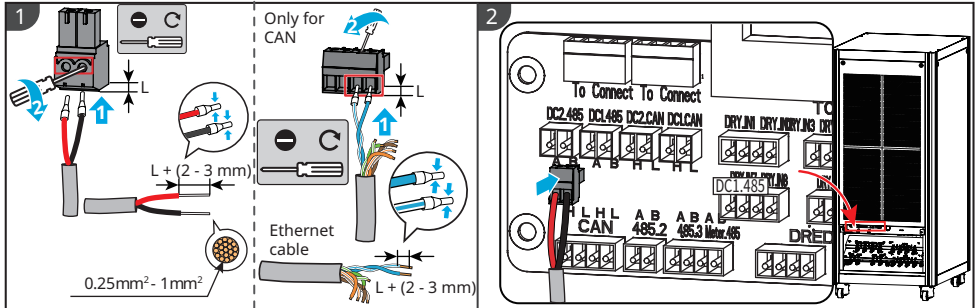

### LAN

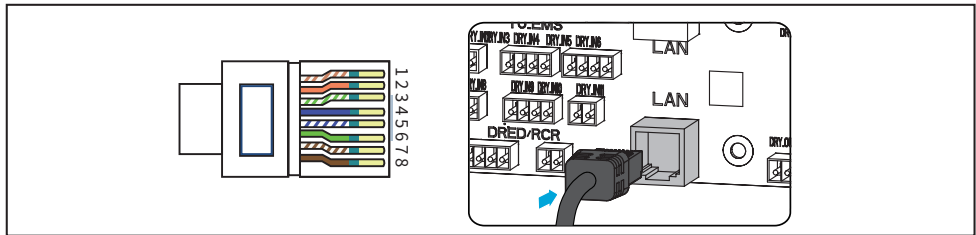

## 6.6.3 Equip communication cable with magnetic ring(optional)

### NOTICE

If the communication is not connected, the magnetic ring can be install on the corresponding communication cable to improve communication quality.

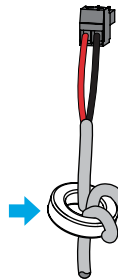

**Power Limit Network**

**NOTICE**

Power limit can be realized when the inverter is installed with a smart meter(GM3000C,GM330)

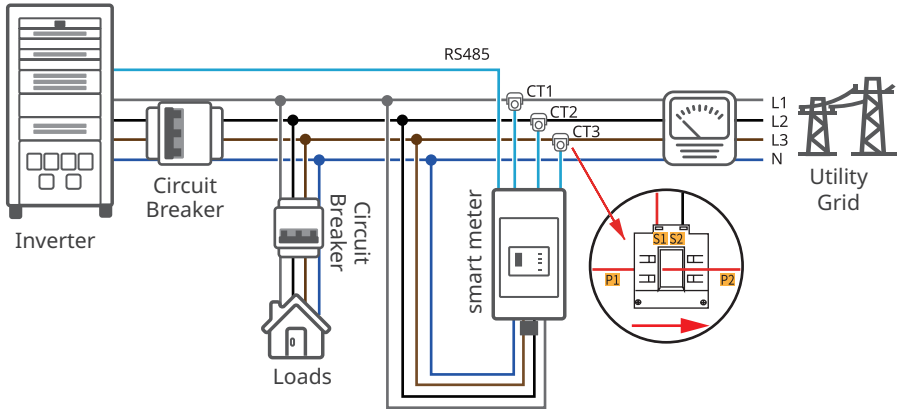

**6.5 Closing the Door of the Wiring Compartment**

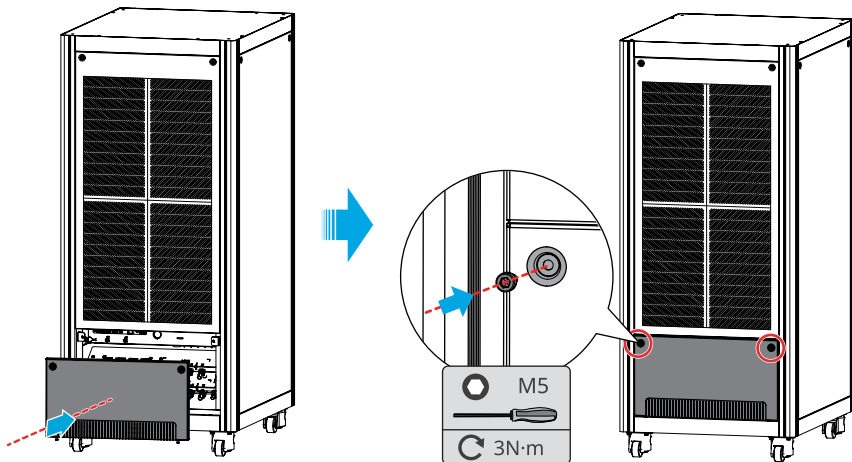

## 7 Equipment Commissioning

### 7.1 Check Before Power ON

No.	Check Item
1	The inverter is firmly installed at a clean place that is well-ventilated and easy to operate.
2	The PE cable, DC input cable, battery cable, AC output cable, and communication cable are connected correctly and securely.
3	Cable ties are intact, routed properly and evenly.
4	The voltage and frequency at the connection point meet the inverter grid connection requirements.
5	The door of the wiring compartment is locked.
6	All the upstream and downstream breakers are disconnected.

### 7.2 Power On











**Step 1** Turn on the battery breaker of the inverter.

**Step 2** Turn on the MPPT input breaker of the inverter(Only for ETC series).

**Step 3** Turn on the AC breaker of the inverter.

## 8 System Commissioning

### 8.1 Indicators and Buttons

Indicator Status		Description
 Power		ON=INVERTER POWER-ON
		OFF=INVERTER POWER-OFF
 Operating		ON=SYSTEM IS READY
		BLINK=SYSTEM IS STARTING UP
		OFF=SYSTEM IS NOT OPERATING
 Fault		ON=FAULT HAS OCCUREED
		BLINK=BURN-IN MODE
		OFF=NO FAULT

### 8.2 Setting Inverter Parameters via LCD

#### NOTICE

- The LCD display automatically turns on and enters the main page after the inverter is powered on.
- A password is required to access the settings page, contact the after-sales service center to obtain one.
- Inverter firmware version shown in this document is V00.0. Communication version: V1.0. The screenshots are for reference only. The actual interface may differ.
- The name, range, and default value of the parameters are subject to change or adjustment. The actual display prevails.
- The power parameters should be set by professionals. To prevent the generating capacity from being influenced by wrong parameters.

#### LCD Button Description

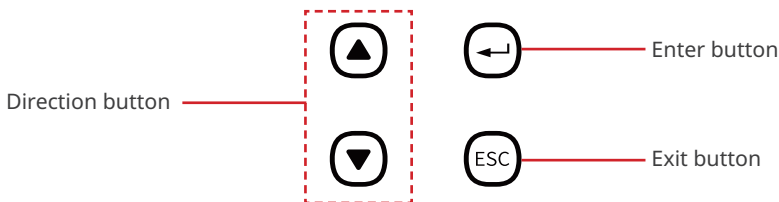

- Short press the direction button: switch to submenus or adjust the parameter values.
- Short press the enter button: go to the next level submenu.
- Long press the enter button: set the parameters after adjusting the values.
- Short press the exit button: back to the upper level menu.

### Display screen icon description

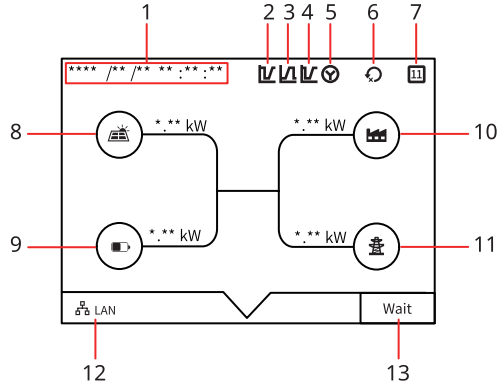

No.	Icon	Description
1	Date Time	Check the time in the country/region where the inverter is located.
2	Low voltage ride through(LVRT)	Indicates that the inverter's LVRT is enabled.
3	High voltage ride through(HVRT)	Indicates that the inverter's HVRT is enabled.
4	LVRT&HVRT	Indicates that the inverter's LVRT&HVRT are enabled.
5	Power grid type	Indicates that the power grid adopted star connection.
6	Power limit	Indicates that the inverter's power limit is enabled.
7	Safety code	Displays the current safety code of the inverter.
8	Solar panel	-
9	Battery	-
10	Load	-
11	Power grid	-
12	Communication method	Display the communication method of the inverter.
13	Status information	Display the status information of the inverter.

Example:

Check communication connection

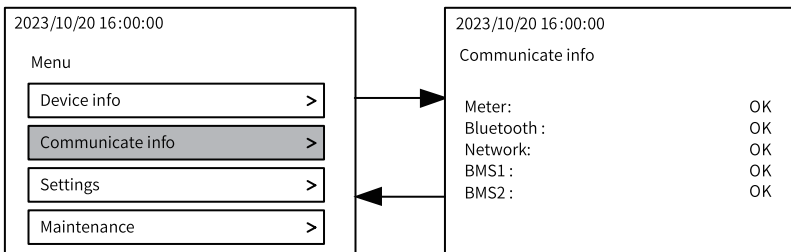

### Set the Safety Code

For Australian market, to comply with AS/NZS 4777.2:2020, please select from Australia A/B/C. please contact your local grid operator on which region to select.

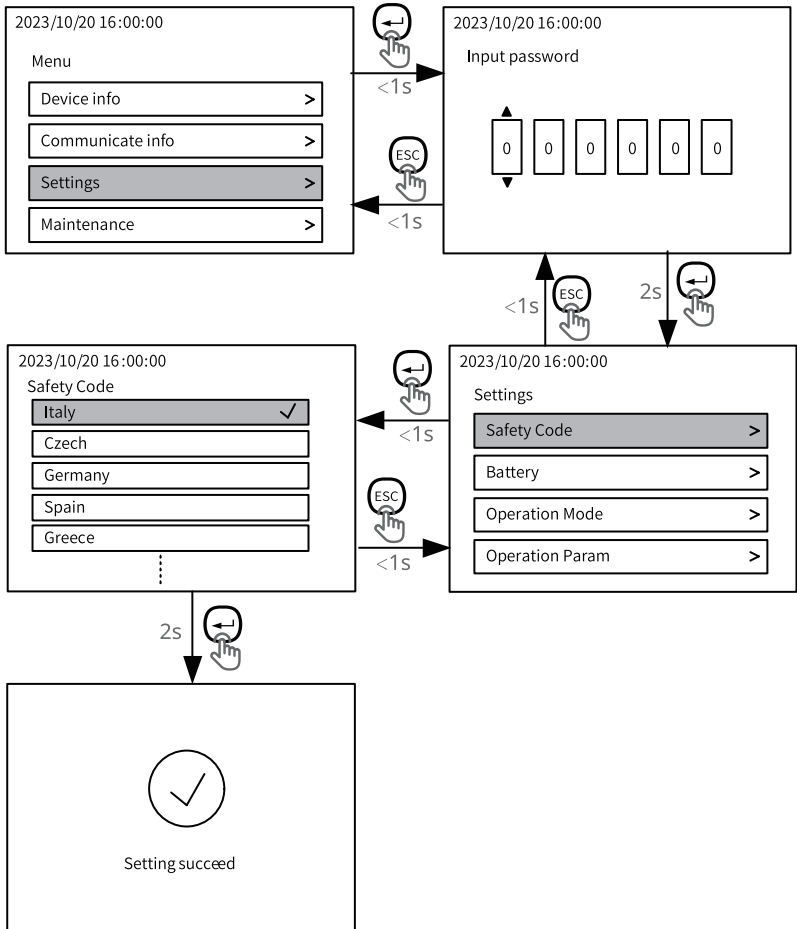

Refer to the appendix for more details.



### 8.3 Setting Inverter Parameters via SolarGo App

#### NOTICE

Please set the inverter parameters first via SolarGo app to ensure its operation.

SolarGo app is a smart phone application used to communicate with the inverter via bluetooth, WiFi, 4G or GPRS modules. Commonly used functions are as follows:

1. Check the operating data, software version, alarms, etc.
2. Set grid parameters, communication parameters, etc.
3. Equipment maintenance.
4. Upgrade software version.

For more details, refer to SolarGo User Manual. Scan the QR code or visit [https://en.goodwe.com/Ftp/EN/Downloads/User%20Manual/GW\\_SolarGo\\_User%20Manual-EN.pdf](https://en.goodwe.com/Ftp/EN/Downloads/User%20Manual/GW_SolarGo_User%20Manual-EN.pdf) to get the user manual.



SolarGo App



SolarGo App User Manual

### 8.4 Monitoring via SEMS Portal

SEMS Portal is an monitoring platform used to manage organizations/users, add plants, and monitor plant status.

For more details, refer to the SEMS Portal User Manual. Scan the QR code or visit [https://en.goodwe.com/Ftp/EN/Downloads/User%20Manual/GW\\_SEMS%20Portal-User%20Manual-EN.pdf](https://en.goodwe.com/Ftp/EN/Downloads/User%20Manual/GW_SEMS%20Portal-User%20Manual-EN.pdf) to get the user manual.



SEMS Portal



SEMS Portal User Manual

## 9 Maintenance

### 9.1 Power OFF the Inverter



#### DANGER

- Power off the inverter before operations and maintenance. Otherwise, the inverter may be damaged or electric shocks may occur.
- Delayed discharge. Wait until the components are discharged after power off.

**Step 1** Turn off the AC breaker of the inverter.

**Step 2** Turn off the MPPT input breaker of the inverter(Only for ETC series).

**Step 3** Turn off the battery breaker of the inverter.

### 9.2 Removing the Inverter



#### WARNING

- Make sure that the inverter is powered off.
- Wear proper PPE before any operations.

**Step 1** Open the door of the wiring compartment.

**Step 2** Disconnect all the cables, including DC cables, AC cables, battery cables, communication cables, and PE cables.

**Step 3** Store the inverter properly. Ensure that the storage conditions meet the requirements for future use.

### 9.3 Disposing of the Inverter

If the inverter cannot work anymore, dispose of it according to the local disposal requirements for electrical equipment waste. The inverter cannot be disposed of together with household waste.

### 9.4 Troubleshooting

Perform troubleshooting according to the following methods. Contact the after-sales service if these methods do not work.

Collect the information below before contacting the after-sales service, so that the problems can be solved quickly.

1. Inverter information like serial number, software version, installation date, fault time, fault frequency, etc.
2. Installation environment, including weather conditions, whether the PV modules are sheltered or shadowed, etc. It is recommended to provide some photos and videos to assist in analyzing the problem.
3. Utility grid situation.

**Monitoring unit fault**

No.	Fault	Cause	Solutions
1	Stop Button On	The emergency stop button on the inverter is pressed.	Check whether the emergency stop button is pressed. If the button is pressed, release it. Contact the dealer or the after-sales service if the problem persists.
2	Internal Communication Fault	The communication between the monitoring unit module and one or more of the MPPT modules, DC conversion modules, or DC-AC conversion modules is abnormal.	<ol style="list-style-type: none"> <li>1. Identify the module with abnormal communication via the LCD.</li> <li>2. Power off the inverter and unscrew the module to replug it. Make sure that the module is installed securely. Tighten the screws of the module.</li> <li>3. Power on the inverter and check whether the module can work properly via LCD. Contact the dealer or the after-sales service if the problem persists.</li> </ol>
3	Remote Turn Off	The remote shutdown communication port connection on the inverter is in a disconnected state.	<ol style="list-style-type: none"> <li>1. Check if the remote shutdown control switch is closed.</li> <li>2. Check if the remote shutdown communication port wiring of the inverter is normal.</li> </ol>
4	Neutral Line Loss	Neutral cables are not connected well on AC side or just an occasional failure.	Check if the AC circuit or switch is disconnected.
5	Error parallel setting	The number of working parallel machines or the rated total power of total working machine is greater than the setted parallel value	Match the number of parallel devices and the rated total power with the set value
6	Master setup error	There are multiple masters machine on the system	Make sure the configuration in the parallel environment only have one master machine

No.	Fault	Cause	Solutions
7	Slaver setup error	Device which working at standalone joins into parallel working system	Change the device from standalone mode to parallel configuration
8	Parallel communication failure	Communication timeout between slave machine and master machine	Check the connection status of the parallel communication line with the master machine
9	Master shutdown setting	The master machine issues a shutdown command to the slave machine	Clear the emergency stop, meter communication failure, or parallel fault 1 or parallel fault 2 of the main equipment
10	CLS Fault	CLS fault triggered under UK safety regulation g100	Equipment shutdown or adjusting actual output to within the limit range
11	Meter communication failure	Communication between the host and the meter times out	Check whether the meter is connected correctly
12	SPD Warning	"1.A lightning strike causes spd to detect an anomaly 2.The spd device is damaged or connected improperly"	Normal operation is not affected. If lightning strikes do occur, it is recommended to stop for maintenance; If the fault is a false alarm, power it on again and check whether the alarm is cleared. If the alarm persists, contact your dealer or after-sales service center.

**MPPT module and DC-DC conversion module fault**

No.	Fault	Cause	Solutions
1	BusVoltOver	1. The PV voltage is too high. 2. The sampling of the inverter BUS voltage is abnormal.	Disconnect the AC output switch and DC input switch, then connect them 5 minutes later. Contact the dealer or the after-sales service if the problem persists.
2	Pv Reverse Fault	The PV string is connected reversely.	Check whether the PV strings are connected reversely.
3	BatReverseConnect	The battery is connected reversely.	Check whether the battery is connected reversely.

**DC-AC conversion module fault**

No.	Fault	Cause	Solutions
1	GFCICheckFault	The leakage current sensor is abnormal.	Disconnect the AC output switch and DC input switch, then connect them 5 minutes later. Contact the dealer or the after-sales service if the problem persists.
2	HCTCheckFault	The sampling of the AC HCT is abnormal.	Disconnect the AC output switch and DC input switch, then connect them 5 minutes later. Contact the dealer or the after-sales service if the problem persists.
3	DcPreChgRlyFault	The input precharge relay is abnormal.	Disconnect the AC output switch and DC input switch, then connect them 5 minutes later. Contact the dealer or the after-sales service if the problem persists.
4	GFCIFailure	The input insulation resistance becomes low when the inverter is working.	<ol style="list-style-type: none"> <li>If the problem occurs occasionally, it may be caused by a cable exception. The inverter will recover automatically after the problem is solved.</li> <li>Check whether the resistance between the PV string and PE is too low if the problem occurs frequently or persists.</li> </ol>
5	RelayFailure	<ol style="list-style-type: none"> <li>The relay is abnormal or short-circuited.</li> <li>The control circuit is abnormal.</li> <li>The AC cable connection is abnormal, like a virtual connection or short circuit.</li> </ol>	Disconnect the AC output switch and DC input switch, then connect them 5 minutes later. Contact the dealer or the after-sales service if the problem persists.
6	HCTCheckFault	The sampling of the AC HCT is abnormal.	Disconnect the AC output switch and DC input switch, then connect them 5 minutes later. Contact the dealer or the after-sales service if the problem persists.
7	NoUtility	<ol style="list-style-type: none"> <li>Utility grid power fails.</li> <li>The AC cable is disconnected, or the AC breaker is disconnected.</li> </ol>	<ol style="list-style-type: none"> <li>The alarm is automatically cleared after the grid power supply is restored.</li> <li>Check whether the AC cable is connected and the AC breaker is on.</li> </ol>

No.	Fault	Cause	Solutions
8	GFCIFault	The input insulation impedance becomes low when the inverter is working.	<ol style="list-style-type: none"> <li>1. If the problem occurs occasionally, it may be caused by a cable exception. The inverter will recover automatically after the problem is solved.</li> <li>2. Check whether the resistance between the PV string and PE is too low if the problem occurs frequently or persists.</li> </ol>
9	BusHighFault	<ol style="list-style-type: none"> <li>1. The PV voltage is too high.</li> <li>2. The sampling of the inverter BUS voltage is abnormal.</li> </ol>	Disconnect the AC output switch and DC input switch, then connect them 5 minutes later. Contact the dealer or the after-sales service if the problem persists.
10	IntFanLockFault	<ol style="list-style-type: none"> <li>1. The power supply to internal fan is abnormal.</li> <li>2. Mechanical failure</li> <li>3. Aged or damaged fans</li> </ol>	<ol style="list-style-type: none"> <li>1. Check whether the fan is blocked.</li> <li>2. Disconnect the AC output switch and DC input switch, then connect them 5 minutes later. Contact the dealer or the after-sales service if the problem persists.</li> </ol>
11	OverTempFault	<ol style="list-style-type: none"> <li>1. The inverter is installed in a place with poor ventilation.</li> <li>2. The ambient temperature is too high.</li> <li>3. A fault occurs in the internal fan of the inverter.</li> </ol>	<ol style="list-style-type: none"> <li>1. Check the ventilation and the ambient temperature at the installation point.</li> <li>2. If the ventilation is poor or the ambient temperature is too high, improve the ventilation and heat dissipation.</li> <li>3. Contact the dealer or after-sales service if both the ventilation and the ambient temperature are proper.</li> </ol>
12	PhaseOrderFault	The cables are connected in a wrong phase.	Disconnect the AC output switch and DC input switch and wait for 5 minutes. Then connect the phase cables in the right way.
13	NLineFault	The N wire is not connected.	Check whether the N wires on Grid side and Load side are well connected.

No.	Fault	Cause	Solutions
14	GridVoltFault	The grid voltage exceeds the permissible range, or the duration of high voltage exceeds the requirement of HVRT.	<ol style="list-style-type: none"> <li>1. If the problem occurs occasionally, the utility grid may be abnormal temporarily. The inverter will recover automatically after detecting that the utility grid is normal.</li> <li>2. If the problem occurs frequently, check whether the grid voltage is within the permissible range. <ul style="list-style-type: none"> <li>• Contact the local power company if the grid voltage exceeds the permissible range.</li> <li>• Modify the overvoltage protection threshold, HVRT or disable the overvoltage protection function after obtaining the consent of the local power company if the grid frequency is within the permissible range.</li> </ul> </li> <li>3. Check whether the AC breaker and the output cables are connected securely and correctly if the problem persists.</li> </ol>
15	IsolationFault (PV array earth fault)	<ol style="list-style-type: none"> <li>1. The PV string is short-circuited to PE.</li> <li>2. The PV system is in a moist environment and the cable is not well insulated to the ground.</li> </ol>	<p>Check whether the resistance of the PV string to PE exceeds 50kΩ. If no, check the short circuit point.</p> <p>Check whether the PE cable is connected correctly.</p> <p>If the resistance is lower than default on rainy days, please reset the ISO.</p> <p>In Australian and New Zealand, customers can also be alerted in the following ways in the event of insulation impedance failure: The inverter is equipped with the buzzer, and the buzzer will sound continuously for 1 minute in case of failure.</p> <p>If the problem persists, the buzzer sounds every 30 minutes.</p> <p>Add the inverter to the monitoring platform, and set the alarm reminder, the alarm information can be sent to the customer by emails.</p>

No.	Fault	Cause	Solutions
16	DCIOutOfRange	DC injection is high.	<ol style="list-style-type: none"> <li>1. If the problem occurs occasionally, the utility grid may be abnormal temporarily. The inverter will recover automatically after detecting that the utility grid is normal.</li> <li>2. If the problem occurs frequently, contact the dealer or the after-sales service.</li> </ol>
17	BackupOutputFail	Loads connected to the back-up of the inverter exceeds the range specified by the inverter.	Reduce the number of loads connected to the back-up of the inverter. Make sure that the power of the loads does not exceeds the max output power of back-up.
18	StsTurnToOffGridFault	STS fails to transfer on-grid to off-grid	Reduce the number of loads connected to the back-up of the inverter. Check whether there are abnormalities such as short circuits.
19	DcRlyFault	DC realy exception.	Disconnect the AC output switch and DC input switch, then connect them 5 minutes later. Contact the dealer or the after-sales service if the problem persists.
20	GridFreqFault	Utility grid exception. The actual grid frequency exceeds the requirement of the local grid standard.	<ol style="list-style-type: none"> <li>1. If the problem occurs occasionally, the utility grid may be abnormal temporarily. The inverter will recover automatically after detecting that the utility grid is normal.</li> <li>2. If the problem occurs frequently, check whether the grid frequency is within the permissible range. <ul style="list-style-type: none"> <li>• Contact the local power company if the grid frequency exceeds the permissible range.</li> <li>• Modify the overfrequency protection threshold or disable the overfrequency protection function after obtaining the consent of the local power company if the grid frequency is within the permissible range.</li> </ul> </li> </ol>
21	EepromRWFault	Data memory device exception.	Disconnect the AC output switch and DC input switch, then connect them 5 minutes later. Contact the dealer or the after-sales service if the problem persists.



No.	Fault	Cause	Solutions
22	SPIComFault	<ol style="list-style-type: none"> <li>1. Frame format error</li> <li>2. Parity checking error</li> <li>3. Can bus offline</li> <li>4. Hardware CRC error</li> <li>5. Send (receive) control bit is receive (send).</li> <li>6. Transmit to the unit that is not allowed.</li> </ol>	Disconnect the AC output switch and DC input switch, then connect them 5 minutes later. Contact the dealer or the after-sales service if the problem persists.

### On-grid/off-grid switching module fault

No.	Fault	Cause	Solutions
1	HCTCheckFault	The sampling of the AC HCT is abnormal.	Disconnect the AC output switch and DC input switch, then connect them 5 minutes later. Contact the dealer or the after-sales service if the problem persists.
2	NoUtility	<ol style="list-style-type: none"> <li>1. Utility grid exception.</li> <li>2. The AC cable is disconnected, or the AC breaker is disconnected.</li> </ol>	<ol style="list-style-type: none"> <li>1. The alarm is automatically cleared after the grid power supply is restored.</li> <li>2. Check whether the AC cable is connected and the AC breaker is on.</li> </ol>
3	OverTempFault	<ol style="list-style-type: none"> <li>1. The inverter is installed in a place with poor ventilation.</li> <li>2. The ambient temperature is too high.</li> <li>3. A fault occurs in the internal fan of the inverter.</li> </ol>	<ol style="list-style-type: none"> <li>1. Check the ventilation and the ambient temperature at the installation point.</li> <li>2. If the ventilation is poor or the ambient temperature is too high, improve the ventilation and heat dissipation.</li> <li>3. Contact the dealer or after-sales service if both the ventilation and the ambient temperature are proper.</li> </ol>

No.	Fault	Cause	Solutions
4	PhaseOrderFault	The cables are connected in a wrong phase.	Disconnect the AC output switch and DC input switch and wait for 5 minutes. Then connect the phase cables in the right way.
5	IntFanLockFault	<ol style="list-style-type: none"> <li>1. The power supply to internal fan is abnormal.</li> <li>2. Mechanical failure</li> <li>3. Aged or damaged fans</li> </ol>	<ol style="list-style-type: none"> <li>1. Check whether the fan is blocked.</li> <li>2. Disconnect the AC output switch and DC input switch, then connect them 5 minutes later. Contact the dealer or the after-sales service if the problem persists.</li> </ol>
6	GridVoltFault	The grid voltage exceeds the permissible range, or the duration of high voltage exceeds the requirement of HVRT.	<ol style="list-style-type: none"> <li>1. If the problem occurs occasionally, the utility grid may be abnormal temporarily. The inverter will recover automatically after detecting that the utility grid is normal.</li> <li>2. If the problem occurs frequently, check whether the grid voltage is within the permissible range. <ul style="list-style-type: none"> <li>• Contact the local power company if the grid voltage exceeds the permissible range.</li> <li>• Modify the overvoltage protection threshold, HVRT or disable the overvoltage protection function after obtaining the consent of the local power company if the grid frequency is within the permissible range.</li> </ul> </li> <li>3. Check whether the AC breaker and the output cables are connected securely and correctly if the problem persists.</li> </ol>

No.	Fault	Cause	Solutions
7	GridFreqFault	Utility grid exception. The actual grid frequency exceeds the requirement of the local grid standard.	<ol style="list-style-type: none"> <li>1. If the problem occurs occasionally, the utility grid may be abnormal temporarily. The inverter will recover automatically after detecting that the utility grid is normal.</li> <li>2. If the problem occurs frequently, check whether the grid frequency is within the permissible range. <ul style="list-style-type: none"> <li>• Contact the local power company if the grid frequency exceeds the permissible range.</li> <li>• Modify the overfrequency protection threshold or disable the overfrequency protection function after obtaining the consent of the local power company if the grid frequency is within the permissible range.</li> </ul> </li> </ol>
8	EepromFault	Data memory device exception.	Disconnect the AC output switch and DC input switch, then connect them 5 minutes later. Contact the dealer or the after-sales service if the problem persists.

**BMS fault**

No.	Fault	Cause	Solutions
1	Over Voltage Charging 2	Battery charge over voltage	keep battery in waiting status for 2 hours, if it doesn't work please contact customer service center.
2	Under Voltage Discharging 2	Battery voltage is low	connect battery to suitable inverter, and set charge setting, wait for the volatage of battery recovering to normal level.
3	Cell Temp. High 2	Battery Cell Temperature High 2	shut down battery for 2 hours, wait for battery temperature recovery and restart battery, if issue persists, please contact customer service center.
4	Cell Temp. Low 2	Battery Cell Temperature Low 2	shut down battery for 2 hours, wait for battery temperature recovery and restart battery, if issue persists, please contact customer service center.
5	Over Current Charging 2	Battery charge over current	Restart battery, if not work, please contact with customer service center.
6	Over Current Discharging 2	Battery discharge over current	Restart battery, if not work, please contact with customer service center.
7	Pre-charging Fault	Pre-charging failure	Restart battery, if not work, please contact with customer service center.
8	DC Fault	DC Failure	Restart battery, if not work, please contact with customer service center.
9	Battery breaker trip	Battery breaker trip	Restart battery, if not work, please contact with customer service center.
10	Battery Blocked	Battery internal hardware fault	Restart battery, if not work, please contact with customer service center.
11	Discharging Circuit Fault	Discharging circuit hardware failure	Restart battery, if not work, please contact with customer service center.
12	Charging Circuit Fault	Charging circuit hardware failure	Restart battery, if not work, please contact with customer service center.

No.	Fault	Cause	Solutions
13	Comm Fault 2	The communication between battery and inverter failed	<p>1.Confirm that the BMS communication cable sequence is correct according to the installation manual,and the connection is normal (use the meter tester to measure the connection).</p> <p>2.Turn on the inverter, connect to the PVmaster locally or connect inverter to SEMS to remotely check the communication protocol through GM to ensure that the protocol is consistent with the battery series.</p> <p>3.Installer need to connect BYD's wifi and log in to its webpage to configure the number of battery cells and inverter manufacturers, as well as the communication protocol. Detials please refer to BYD high voltage battery installation guide (For BYD Battery) .</p> <p>4.Turn on the battery, measure the output voltage of the battery by using a multimeter(inverter side) to see if the output voltage of the battery is normal. Make sure that the positive and negative poles of the battery are connected to the inverter correctly.</p> <p>5.Check and confirm the positive and negative poles of the battery power cable are not reversed to the inverter. Note: ET has polarity protection for high-voltage batteries, but not for low-voltage battery inverters. Reversed battery connection can damage the inverter.</p> <p>6.If the inverter is not connected with GOODWE SEMS, installer can use the calibration tool to modify the active mode with Laptop; if inverter is connected with SEMS, it can be modified remotely through GM by service engineers of Goodwe.</p> <p>7.If the above 6 steps are all normal, it might be the cause of the inverter BMS port, please contact customer service center</p>
14	Cell Overtemperature 3	Cell overtemperature 3	Power off and restart after 2 hours.If the problem persists,please contact with customer service center

No.	Fault	Cause	Solutions
15	Under Voltage Discharging 3	Undervoltage discharging 3	Wait for inverter charge battery if the charging condition could be met, after the voltage increase, it will be normal
16	Overvoltage Charging 3	Overvoltage charging 3	Make inverter stand-by for 2h, if not work, please contact with customer service center
17	Over Temp. Charging 2	Overtemperature Charging 2	Power off and restart after 2 hours. If the problem persists, please contact with customer service center
18	Low Temp. Charging 2	Low Temperature Charging 2	Wait for inverter discharge to make temperature increasing
19	Over Temp. Discharging 2	Over Temperature Discharging 2	Power off and restart after 2 hours. If the problem persists, please contact with customer service center
20	Low Temp. Discharging 2	Low Temperature Discharging 2	Wait for inverter discharge to make temperature increasing, change the installation environment if possible
21	Cell Temp. Difference Large 2	Cell temperature difference large 2	Power off and restart after 2 hours. If the problem persists, please contact with customer service center
22	Cell Over Voltage 2	Cell overvoltage 2	Restart battery, if not work, please contact with customer service center
23	Cell Low Voltage 2	Cell low voltage 2	Wait for inverter charge battery if the charging condition could be met, after the voltage increase, it will be normal
24	Cell Voltage Difference Large 2	Cell voltage difference large 2	Restart and wait for 12 hours. If the problem persists, please contact with customer service center
25	Specific Fault	Battery-specific faults (see the table below for specific faults)	Restart battery, if not work, please contact with customer service center

## 9.5 Routine Maintenance

Maintaining Item	Maintaining Method	Maintaining Period
System Clean	Check the air intake, and air outlet for foreign matter or dust.	Once 6-12 months
DC switch, battery breaker, AC breaker, and load breaker	Turn the switches or breakers on and off ten consecutive times to make sure that it is working properly.	Once a year
Electrical Connection	Check whether the cables are securely connected. Check whether the cables are broken or whether there is any exposed copper core.	Once 6-12 months
THDi Test	For Australia requirements, in the THDi test, there should add Zref between inverter and mains. L: $0.15 \Omega + j0.15 \Omega$ ; N: $0.1 \Omega + j0.1 \Omega$	As needed.

## 10 Technical Parameters

Technical Data	GW50K07-ETC	GW50K06-ETC	GW100K07-ETC	GW100K06-ETC
<b>Battery Input Data</b>				
Battery Type	Li-Ion	Li-Ion	Li-Ion	Li-Ion
Nominal Battery Voltage (V)*1	422.4 / 499.2 / 576 / 652.8	422.4 / 499.2 / 576 / 652.8	422.4 / 499.2 / 576 / 652.8	422.4 / 499.2 / 576 / 652.8
Battery Voltage Range (V)	200~865	200~865	200~865	200~865
Start-up Voltage (V)	200	200	200	200
Number of Battery Input	1	1	2	2
Max. Continuous Charging Current (A)	100	100	100/100	100/100
Max. Continuous Discharging Current (A)	100	100	100/100	100/100
Max. Charge Power (kW)	50	50	100	100
Max. Discharge Power (kW)	55	55	110	110
<b>PV String Input Data</b>				
Max. Input Power (kW)	65	65	130	130
Max. Input Voltage (V)	1000	1000	1000	1000
MPPT Operating Voltage Range (V)	250~850	250~850	250~850	250~850
MPPT Voltage Range at Nominal Power (V)	510~850	510~850	510~850	510~850
Start-up Voltage (V)	250	250	250	250
Nominal Input Voltage (V)	600	600	600	600
Max. Input Current per MPPT (A)	100	100	100	100
Max. Short Circuit Current per MPPT (A)	125	125	125	125
Max. Backfeed Current to The Array (A)	0	0	0	0
Number of MPP Trackers	1	1	2	2



Technical Data	GW50K07-ETC	GW50K06-ETC	GW100K07-ETC	GW100K06-ETC
<b>AC Output Data (On-grid)</b>				
Nominal Output Power (kW)	50	50	100	100
Max. Output Power (kW)	55	55	110	110
Nominal Apparent Power Output to Utility Grid (kVA)	50	50	100	100
Max. Apparent Power Output to Utility Grid (kVA)	55	55	110	110
Nominal Apparent Power from Utility Grid (kVA)	50	50	100	100
Max. Apparent Power from Utility Grid (kVA)	55	55	110	110
Nominal Output Voltage (V)	400,3L/N/PE	400,3L/N/PE	400,3L/N/PE	400,3L/N/PE
Output Voltage Range (V)	312~460(AU); 318~497(Germany)	312~460(AU); 318~497(Germany)	312~460(AU); 318~497(Germany)	312~460(AU); 318~497(Germany)
Nominal AC Grid Frequency (Hz)	50/60	50/60	50/60	50/60
AC Grid Frequency Range (Hz)	47~52(AU); 47.5~51.5(Germany)	47~52(AU); 47.5~51.5(Germany)	47~52(AU); 47.5~51.5(Germany)	47~52(AU); 47.5~51.5(Germany)
Max. AC Current Output to Utility Grid (A)	79.8	79.8	159.5	159.5
Max. AC Current From Utility Grid (A)	79.8	79.8	159.5	159.5
Nominal AC Current From Utility Grid (A)	72.5	72.5	145.0	145.0
Max. Output Fault Current (Peak and Duration) (A)	155@62.5us	155@62.5us	310@62.5us	310@62.5us
Inrush Current (Peak and Duration) (A)	160	160	320	320
Nominal Output Current (A)	72.5	72.5	145.0	145.0
Power Factor	~1 (Adjustable from 0.8 leading to 0.8 lagging)	~1 (Adjustable from 0.8 leading to 0.8 lagging)	~1 (Adjustable from 0.8 leading to 0.8 lagging)	~1 (Adjustable from 0.8 leading to 0.8 lagging)

Technical Data	GW50K07-ETC	GW50K06-ETC	GW100K07-ETC	GW100K06-ETC
Max. Total Harmonic Distortion	<3%	<3%	<3%	<3%
Maximum Output Overcurrent Protection (A)	155	155	310	310
<b>AC Output Data (Back-up)</b>				
Back-up Nominal Apparent Power (kVA)	50	NA	100	NA
Max. Output Apparent Power without Grid (kVA)	55	NA	110	NA
Max. Output Apparent Power with Grid (kVA)	55	NA	110	NA
Nominal Output Current (A)	72.5	NA	145.0	NA
Max. Output Current (A)	79.8	NA	159.5	NA
Max. Output Fault Current (Peak and Duration) (A)	155@187.5us	NA	310@187.5us	NA
Inrush Current (Peak and Duration) (A)	160	NA	320	NA
Maximum Output Overcurrent Protection (A)	155	NA	310	NA
Nominal Output Voltage (V)	400	NA	400	NA
Nominal Output Frequency (Hz)	50/60	NA	50/60	NA
Output THDv (@Linear Load)	<3%	NA	<3%	NA
Switching from Grid Connected Mode to Stand/alone Mode	<10ms	NA	<10ms	NA
<b>Efficiency</b>				
Max. Efficiency	97.6%	97.6%	97.6%	97.6%
European Efficiency	97.3%	97.3%	97.3%	97.3%
Max. Battery to AC Efficiency	97.2%	97.2%	97.2%	97.2%
MPPT Efficiency	99.9%	99.9%	99.9%	99.9%
<b>Protection</b>				

Technical Data	GW50K07-ETC	GW50K06-ETC	GW100K07-ETC	GW100K06-ETC
PV Insulation Resistance Detection	Integrated	Integrated	Integrated	Integrated
Residual Current Monitoring	Integrated	Integrated	Integrated	Integrated
PV Reverse Polarity Protection	Integrated	Integrated	Integrated	Integrated
Battery Reverse Polarity Protection	Integrated	Integrated	Integrated	Integrated
Anti-islanding Protection	Integrated	Integrated	Integrated	Integrated
AC Overcurrent Protection	Integrated	Integrated	Integrated	Integrated
AC Short Circuit Protection	Integrated	Integrated	Integrated	Integrated
AC Overvoltage Protection	Integrated	Integrated	Integrated	Integrated
DC Switch	Integrated	Integrated	Integrated	Integrated
AC Switch	Integrated	Integrated	Integrated	Integrated
DC Surge Protection	Type II (Type I+ II Optional)	Type II (Type I+ II Optional)	Type II (Type I+ II Optional)	Type II (Type I+ II Optional)
AC Surge Protection	Type II (Type I+ II Optional)	Type II (Type I+ II Optional)	Type II (Type I+ II Optional)	Type II (Type I+ II Optional)
Emergency Power Off	Integrated	Integrated	Integrated	Integrated
Remote Shutdown	Integrated	Integrated	Integrated	Integrated
<b>General Data</b>				
Operating Temperature Range (°C)	-20~+60(>45°C derating)			
Storage Temperature (°C)	-30~+60			
Relative Humidity	0~95% (Non-condensing)			
Max. Operating Altitude (m)	4000			
Cooling Method	Smart Fan Cooling			
User Interface	LED, LCD , WLAN+APP			
Communication with BMS	CAN, RS485			

Technical Data	GW50K07-ETC	GW50K06-ETC	GW100K07-ETC	GW100K06-ETC
Communication with Meter	RS485			
Communication with Portal	RS485, LAN			
Weight (kg)	184.5	170	239.5	225
Dimension (W×H×D mm)	585 x 1360 x 750			
Noise Emission (dB)	<68			
Topology	Non-isolated			
Ingress Protection Rating	IP20			
DC Connector	OT/DT terminal (Max. 35mm <sup>2</sup> )		OT/DT terminal (Max. 70mm <sup>2</sup> )	
AC Connector	OT/DT terminal (Max. 35mm <sup>2</sup> )		OT/DT terminal (Max. 70mm <sup>2</sup> )	
Environmental Category	3K3			
Pollution Degree	II			
Overvoltage Category	DC II / AC III			
Protective Class	I			
Storage Temperature (°C)	-30~+60			
The Decisive Voltage Class (DVC)	Battery: C PV: C AC: C Com: A			
Mounting Method	Grounded			
Active Anti-islanding Method	AFDPF + AQDPF			
Type of Electrical Supply System	TN-S, TN-C, TN-C-S, TT, IT			
Country of Manufacture	China			

Technical Data	GW50K07-BTC	GW50K06-BTC	GW100K07-BTC	GW100K06-BTC
<b>Battery Input Data</b>				
Battery Type	Li-Ion	Li-Ion	Li-Ion	Li-Ion
Nominal Battery Voltage (V)*1	422.4 / 499.2 / 576 / 652.8	422.4 / 499.2 / 576 / 652.8	422.4 / 499.2 / 576 / 652.8	422.4 / 499.2 / 576 / 652.8
Battery Voltage Range (V)	200~865	200~865	200~865	200~865
Start-up Voltage (V)	200	200	200	200
Max. Continuous Charging Current (A)	100	100	100/100	100/100
Max. Continuous Discharging Current (A)	100	100	100/100	100/100
Max. Charge Power (kW)	50	50	100	100
Max. Discharge Power (kW)	55	55	110	110
No. of Battery Input	1	1	2	2
<b>AC Output Data (On-grid)</b>				
Nominal Output Power (kW)	50	50	100	100
Max. Output Power (kW)	55	55	110	110
Nominal Apparent Power Output to Utility Grid (kVA)	50	50	100	100
Max. Apparent Power Output to Utility Grid (kVA)	55	55	110	110
Nominal Apparent Power from Utility Grid (kVA)	50	50	100	100
Max. Apparent Power from Utility Grid (kVA)	55	55	110	110
Nominal Output Voltage (V)	400,3L/N/PE	400,3L/N/PE	400,3L/N/PE	400,3L/N/PE
Output Voltage Range (V)	312~460(AU); 318~497(Germany)	312~460(AU); 318~497(Germany)	312~460(AU); 318~497(Germany)	312~460(AU); 318~497(Germany)

Technical Data	GW50K07-BTC	GW50K06-BTC	GW100K07-BTC	GW100K06-BTC
Nominal AC Grid Frequency (Hz)	50/60	50/60	50/60	50/60
AC Grid Frequency Range (Hz)	47~52(AU); 47.5~51.5(Germany)	47~52(AU); 47.5~51.5(Germany)	47~52(AU); 47.5~51.5(Germany)	47~52(AU); 47.5~51.5(Germany)
Max. AC Current Output to Utility Grid (A)	79.8	79.8	159.5	159.5
Max. AC Current from Utility Grid (A)	79.8	79.8	159.5	159.5
Nominal AC Current from Utility Grid (A)	72.5	72.5	145.0	145.0
Max. Output Fault Current (Peak and Duration) (A)	155@62.5us	155@62.5us	310@62.5us	310@62.5us
Inrush Current (Peak and Duration) (A)	160	160	320	320
Nominal Output Current (A)	72.5	72.5	145.0	145.0
Power Factor	~1 (Adjustable from 0.8 leading to 0.8 lagging)	~1 (Adjustable from 0.8 leading to 0.8 lagging)	~1 (Adjustable from 0.8 leading to 0.8 lagging)	~1 (Adjustable from 0.8 leading to 0.8 lagging)
Max. Total Harmonic Distortion	<3%	<3%	<3%	<3%
Maximum Output Overcurrent Protection (A)	155	155	310	310
<b>AC Output Data (Back-up)</b>				
Back-up Nominal Apparent Power (kVA)	50	NA	100	NA
Max. Output Apparent Power without Grid (kVA)	55	NA	110	NA
Max. Output Apparent Power with Grid (kVA)	55	NA	110	NA
Nominal Output Current (A)	72.5	NA	145.0	NA
Max. Output Current (A)	79.8	NA	159.5	NA
Max. Output Fault Current (Peak and Duration) (A)	155@187.5us	NA	310@187.5us	NA

Technical Data	GW50K07-BTC	GW50K06-BTC	GW100K07-BTC	GW100K06-BTC
Inrush Current (Peak and Duration) (A)	160	NA	320	NA
Maximum Output Overcurrent Protection (A)	155	NA	310	NA
Nominal Output Voltage (V)	400	NA	400	NA
Nominal Output Frequency (Hz)	50/60	NA	50/60	NA
Output THDv (@Linear Load)	<3%	NA	<3%	NA
Switching from Grid Connected Mode to Standa/lone Mode	<10ms	NA	<10ms	NA
<b>Efficiency</b>				
Max. Efficiency	97.6%	97.6%	97.6%	97.6%
European Efficiency	97.3%	97.3%	97.3%	97.3%
Max. Battery to AC Efficiency	97.2%	97.2%	97.2%	97.2%
<b>Protection</b>				
Residual Current Monitoring	Integrated	Integrated	Integrated	Integrated
Battery Reverse Polarity Protection	Integrated	Integrated	Integrated	Integrated
Anti-islanding Protection	Integrated	Integrated	Integrated	Integrated
AC Overcurrent Protection	Integrated	Integrated	Integrated	Integrated
AC Short Circuit Protection	Integrated	Integrated	Integrated	Integrated
AC Overvoltage Protection	Integrated	Integrated	Integrated	Integrated
DC Switch	Integrated	Integrated	Integrated	Integrated
AC Switch	Integrated	Integrated	Integrated	Integrated
AC Surge Protection	Type II (Type I+ II Optional)	Type II (Type I+ II Optional)	Type II (Type I+ II Optional)	Type II (Type I+ II Optional)
Emergency Power Off	Integrated	Integrated	Integrated	Integrated
Remote Shutdown	Integrated	Integrated	Integrated	Integrated
<b>General Data</b>				

Technical Data	GW50K07-BTC	GW50K06-BTC	GW100K07-BTC	GW100K06-BTC
Operating Temperature Range (°C)	-20~+60(>45°C derating)			
Storage Temperature (°C)	-30~+60			
Relative Humidity	0~95% (Non-condensing)			
Max. Operating Altitude (m)	4000			
Cooling Method	Smart Fan Cooling			
User Interface	LED, LCD , WLAN+APP			
Communication with BMS	CAN, RS485			
Communication with Meter	RS485			
Communication with Portal	RS485, LAN			
Weight (kg)	170.5	156	212	198
Dimension (W×H×D mm)	585 x 1360 x 750			
Noise Emission (dB)	<68			
Topology	Non-isolated			
Ingress Protection Rating	IP20			
DC Connector	OT/DT terminal (Max. 35mm <sup>2</sup> )		OT/DT terminal (Max. 70mm <sup>2</sup> )	
AC Connector	OT/DT terminal (Max. 35mm <sup>2</sup> )		OT/DT terminal (Max. 70mm <sup>2</sup> )	
Environmental Category	3K3			
Pollution Degree	II			
Overtoltage Category	DC II / AC III			
Protective Class	I			
Storage Temperature (°C)	-30~+60			
The Decisive Voltage Class (DVC)	Battery: C; PV: C; AC: C; Com: A			
Mounting Method	Grounded			
Active Anti-islanding Method	AFDPF + AQDPF			
Type of Electrical Supply System	TN-S, TN-C, TN-C-S, TT, IT			
Country of Manufacture	China			



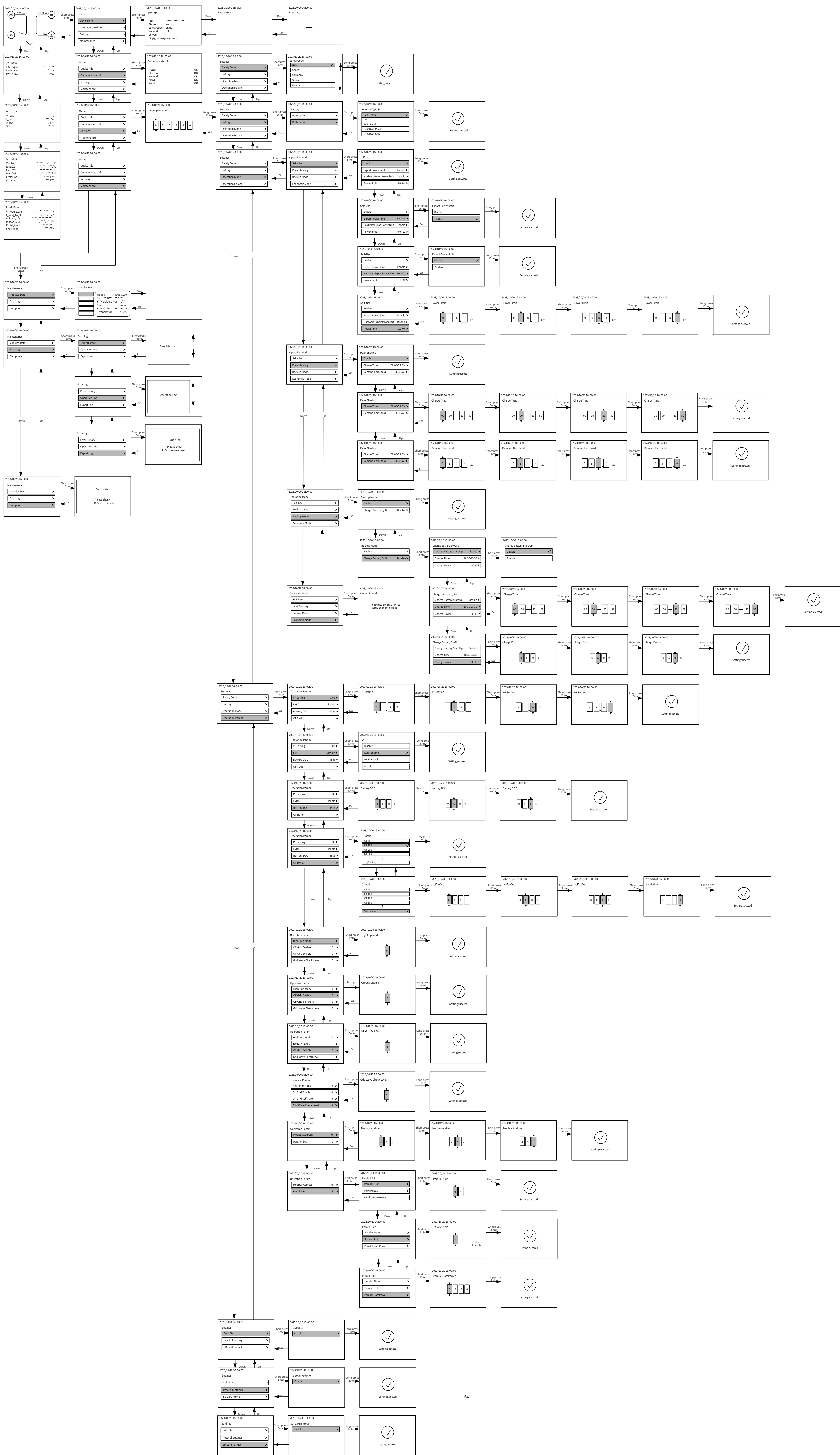



Official Website

**GoodWe Technologies Co.,Ltd.**

---

 No. 90 Zijin Rd., New District, Suzhou, 215011, China

 [www.goodwe.com](http://www.goodwe.com)

 [service@goodwe.com](mailto:service@goodwe.com)



Local Contacts